

915 KF Ti-Touch



Manual – Short Instructions

8.915.8004EN / v5 / 2024-10-30



Metrohm AG
CH-9100 Herisau
Switzerland
+41 71 353 85 85
info@metrohm.com
www.metrohm.com

915 KF Ti-Touch

Manual – Short Instructions

Technical Communication
Metrohm AG
CH-9100 Herisau

This documentation is protected by copyright. All rights reserved.

This documentation is an original document.

This documentation has been prepared with great care. However, errors can never be entirely ruled out. Please send comments regarding possible errors to the address above.

Disclaimer

Deficiencies arising from circumstances that are not the responsibility of Metrohm, such as improper storage or improper use, etc., are expressly excluded from the warranty. Unauthorized modifications to the product (e.g. conversions or attachments) exclude any liability on the part of the manufacturer for resulting damage and its consequences. Instructions and notes in the Metrohm product documentation must be strictly followed. Otherwise, Metrohm's liability is excluded.

Melody for the BEEP command: excerpt from "En Altfrentsche", with kind permission of the Laseyer Quartett, Appenzell.

Table of contents

1	About these short instructions	1
2	Introduction	2
2.1	Instrument description	2
2.1.1	Titration and measuring modes	2
2.1.2	Connectors	3
2.1.3	Intended use	3
2.2	About the documentation	4
2.2.1	Symbols and conventions	4
3	Safety	6
3.1	Intended use	6
3.2	Responsibility of the operator	6
3.3	Requirements for operating personnel	7
3.4	Safety instructions	7
3.4.1	General notes on safety	7
3.4.2	Electrical safety	7
3.4.3	Tubing and capillary connections	8
3.4.4	Flammable solvents and chemicals	9
3.4.5	Recycling and disposal	9
4	Overview of the instrument	10
4.1	Front of the instrument	10
4.2	Rear of the instrument	11
5	Installation	12
5.1	Setting up the instrument	12
5.1.1	Packaging	12
5.1.2	Checks	12
5.1.3	Location	12
5.2	Connecting the power supply unit	12
5.3	Mounting the KF titration cell	14
5.4	Connecting MSB devices	15
5.4.1	Connecting a dosing device	16
5.4.2	Connecting an additional stirrer or titration stand	17
5.4.3	Connecting a Remote Box	17
5.5	Connecting USB devices	18
5.5.1	General	18
5.5.2	Connecting a USB hub	18
5.5.3	Connecting a printer	18



5.5.4	Connecting a balance	19
5.5.5	Connecting a PC keyboard	20
5.5.6	Connecting a barcode reader	20
5.5.7	Connecting a Sample Processor	21
5.5.8	Connecting the 885 Compact Oven SC	22
5.6	Setting up the titration vessel	23
5.7	Connecting sensors	23
5.7.1	General	23
5.7.2	Connecting a polarizable electrode	23
5.7.3	Connecting the temperature sensor	24
5.8	Connecting the Ti-Touch to a network	25
6	Operation	27
6.1	Switching the instrument on and off	27
6.2	Fundamentals of operation	29
6.2.1	Touch-sensitive screen	29
6.2.2	Display elements and controls	30
6.2.3	Status display	31
6.2.4	Entering text and numbers	32
7	Maintenance	34
	Index	35

1 About these short instructions

The present short instructions contain important chapters from the more detailed manual. In addition to an introduction, safety instructions and an overview of the instruments, you will also find information about the installation and operation of the 915 KF Ti-Touch in addition to documents regarding conformity and warranty. You will find the more detailed manual as a PDF file on the external storage medium included in the scope of delivery.

- **MEAS**

Measuring modes:

- **Ipol** (voltametric measurement with selectable polarization current)
- **Upol** (amperometric measurement with selectable polarization voltage)
- **T** (temperature measurement)

2.1.2 Connectors

The 915 KF Ti-Touch is equipped with the following connectors:

- **Power connection**
For connecting to the power grid using the power supply unit provided.
- **Two MSB connectors (Metrohm Serial Bus)**
For connecting dosing devices, one additional stirrer or a Remote Box.
- **USB connector**
For connecting peripheral devices (printer, PC keyboard, etc.), a USB flash drive, a Sample Processor or a USB hub.
- **Sensor connectors**
One connector each for:
 - Polarizable electrodes
 - Temperature sensor (Pt1000 or NTC)
- **Ethernet connector**
For connecting the Ti-Touch to a network.
- **Two connection nipples**
For connecting tubing for aspirating solvent and extracting the contents of the titration cell.

2.1.3 Intended use

The 915 KF Ti-Touch is designed for usage as a titrator in analytical laboratories. Its application field is volumetric Karl Fischer titration.

This instrument is suitable for processing chemicals and flammable samples. Therefore, the use of the instrument requires the user to have basic knowledge and experience in handling toxic and caustic substances. Knowledge regarding the application of fire prevention measures prescribed for laboratories is also mandatory.

2.2 About the documentation







CAUTION

Please read through this documentation carefully before putting the instrument into operation. The documentation contains information and warnings which the user must follow in order to ensure safe operation of the instrument.

2.2.1 Symbols and conventions

The following symbols and formatting may appear in this documentation:

<i>(5-12)</i>	Cross-reference to figure legend The first number refers to the figure number, the second to the instrument part in the figure.
1	Instruction step Perform the steps one after the other.
Method	Dialog text, parameter in the software
File ► New	Menu or menu item
[Continue]	Button or key
	WARNING This symbol draws attention to a possible life-threatening hazard or risk of injury.
	WARNING This symbol draws attention to a possible hazard due to electrical current.
	WARNING This symbol draws attention to a possible hazard due to heat or hot instrument parts.
	WARNING This symbol draws attention to a possible biological hazard.
	WARNING Warning of optical radiation



CAUTION

This symbol draws attention to possible damage to instruments or instrument parts.



NOTICE

This symbol highlights additional information and tips.

3.3 Requirements for operating personnel

Only qualified personnel may operate the product. Qualified personnel are persons who meet the following requirements:

- Basic regulations on occupational safety and accident prevention for chemical laboratories are known and complied with.
- Knowledge of handling hazardous chemicals is present. Personnel have the ability to recognize and avoid potential dangers.
- Knowledge regarding the application of fire prevention measures for laboratories is available.
- Safety-relevant information is communicated and understood. The personnel can operate the product safely.
- The user documentation has been read and understood. The personnel operate the product according to the instructions in the user documentation.

3.4 Safety instructions

3.4.1 General notes on safety



WARNING

Operate this instrument only according to the information contained in this documentation.

This instrument left the factory in a flawless state in terms of technical safety. To maintain this state and ensure non-hazardous operation of the instrument, the following instructions must be observed carefully.

3.4.2 Electrical safety

The electrical safety when working with the instrument is ensured as part of the international standard IEC 61010.



WARNING

Only personnel qualified by Metrohm are authorized to carry out service work on electronic components.

**WARNING**

Never open the housing of the instrument. The instrument could be damaged by this. There is also a risk of serious injury if live components are touched.

There are no parts inside the housing which can be serviced or replaced by the user.

Supply voltage**WARNING**

An incorrect supply voltage can damage the instrument.

Only operate this instrument with a supply voltage specified for it (see rear panel of the instrument).

Protection against electrostatic charges**WARNING**

Electronic components are sensitive to electrostatic charges and can be destroyed by discharges.

Do not fail to pull the power cord out of the power socket before you set up or disconnect electrical plug connections at the rear of the instrument.

3.4.3 Tubing and capillary connections**CAUTION**

Leaks in tubing and capillary connections are a safety risk. Tighten all connections well by hand. Avoid applying excessive force to tubing connections. Damaged tubing ends lead to leakage. Appropriate tools can be used to loosen connections.

Check the connections regularly for leakage. If the instrument is used mainly in unattended operation, then weekly inspections are mandatory.

3.4.4 Flammable solvents and chemicals



WARNING

All relevant safety measures are to be observed when working with flammable solvents and chemicals.

- Set up the instrument in a well-ventilated location (e.g. fume cupboard).
- Keep all sources of flame far from the workplace.
- Clean up spilled liquids and solids immediately.
- Follow the safety instructions of the chemical manufacturer.

3.4.5 Recycling and disposal

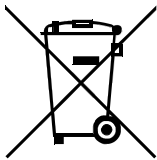

Properly dispose of chemicals and of the product to reduce negative effects on the environment and public health. Local authorities, waste disposal companies or dealers provide more detailed information on disposal. Observe the WEEE EU directive (WEEE = Waste Electrical and Electronic Equipment) for the proper disposal of waste electronic equipment within the European Union.

4 Overview of the instrument

4.1 Front of the instrument

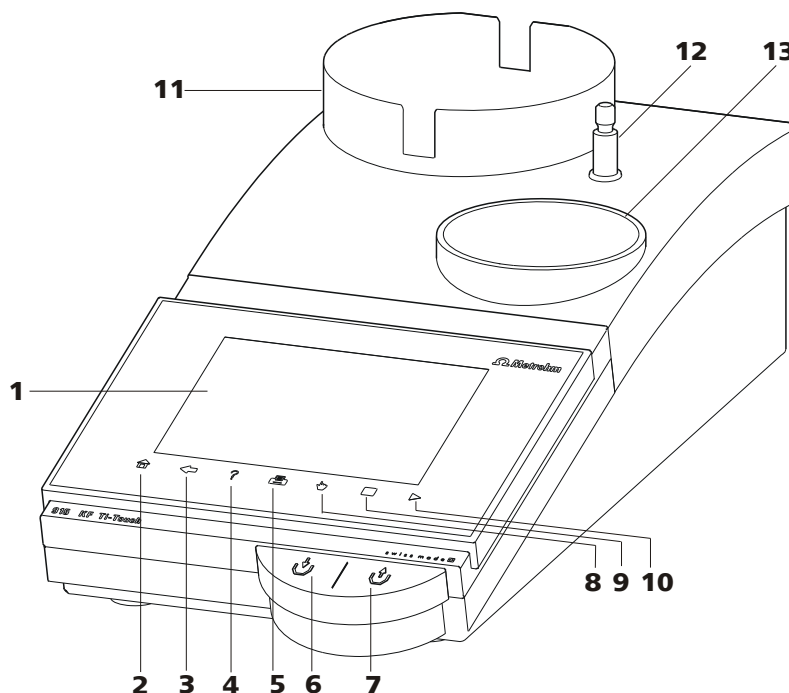

Figure 1 Front 915 KF Ti-Touch

<p>1 Display Touch screen.</p>	<p>2 Fixed key [Home] Opens the main dialog.</p>
<p>3 Fixed key [Back] Saves the entry and opens the next-higher dialog page.</p>	<p>4 Fixed key [Help] Opens the online help for the dialog displayed.</p>
<p>5 Fixed key [Print] Opens the print dialog.</p>	<p>6 Key Pressing the key pumps air into the solvent bottle. The overpressure in the solvent bottle pushes solvent into the KF titration cell.</p>
<p>7 Key Pressing the key aspirates air out of the aspiration bottle. The vacuum in the aspiration bottle suctions the liquid out of the KF titration cell and into the aspiration bottle.</p>	<p>8 Fixed key [Manual] Opens the manual control.</p>
<p>9 Fixed key [STOP] Cancels the running determination.</p>	<p>10 Fixed key [START] Starts a determination.</p>

11 Bottle holder

With holding clips, for reagent bottle.

12 Support rod (lower part)

For mounting the support rod (upper part).

13 Titration stand

With built-in magnetic stirrer and membrane pump for placement of the titration cell.

4.2 Rear of the instrument

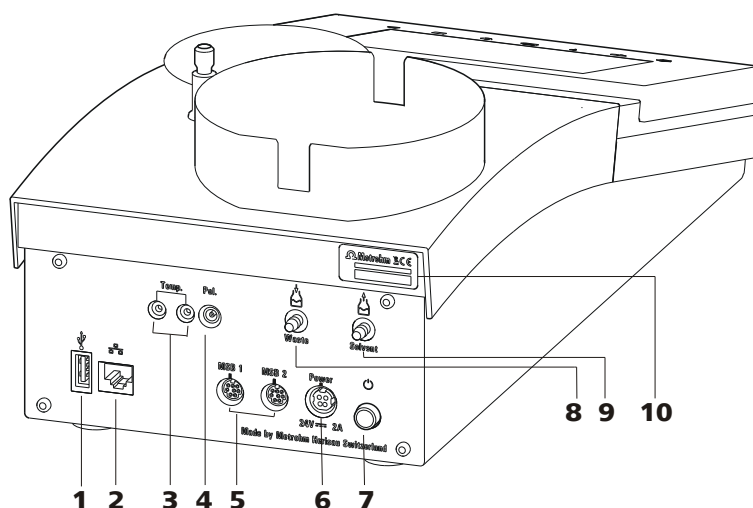

Figure 2 915 KF Ti-Touch rear

1 USB connector (type A)

For connecting a printer, USB flash drive, USB hub, Sample Processor etc.

2 Ethernet connector (RJ-45)

For connecting to a network.

3 Temperature sensor connector (Temp.)

For connecting temperature sensors (Pt1000 or NTC). Two B sockets, 2 mm.

4 Electrode connector (Pol.)

For connecting polarizable electrodes, e.g. double Pt electrodes. Socket F.

5 MSB connector (MSB 1 and MSB 2)

Metrohm Serial Bus. For connecting external dosing devices, stirrers or a Remote Box. Mini DIN, 8-pin.

6 Power socket (Power)

For connecting the external power supply unit.

7 Power switch

Switches the instrument on/off.

8 Connection nipple for PVC tubing

For aspirating the contents of the titration cell.

9 Connection nipple for PVC tubing

For aspirating solvent.

10 Type plate

Contains the serial number.

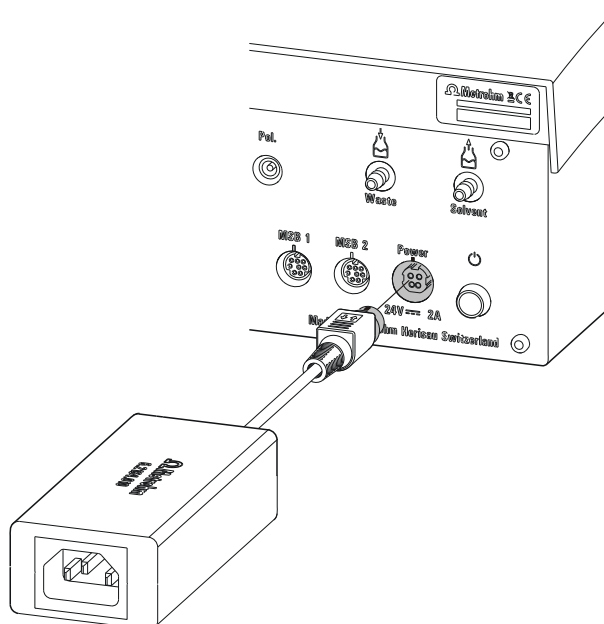

Figure 3 Connecting the power supply unit

Proceed as follows:

- 1 Connect the plug of the external power supply unit with the power socket of the Ti-Touch (see figure 3, page 13).



NOTE

The plug of the power supply unit is protected against accidental disconnection of the cable by means of a pull-out protection feature. If you wish to pull out the plug, you first need to pull back the outer plug sleeve marked with arrows.

- 2 Connect the power cord with the external power supply unit of the Ti-Touch and with the power grid.



CAUTION

Switch off the Ti-Touch correctly by pressing the power switch before you disconnect the electricity supply. If this is not done, then there is a danger of data loss.

5.3 Mounting the KF titration cell

The KF titration cell can be mounted with the aid of the upper part of KF titration cell.



NOTE

To prevent damage to the KF titration cell, the permissible height above the stirrer can be fixed with the aid of the clamping ring at the upper part of the KF titration cell.

Proceed as follows:

- 1** Push the clamping ring (6.2013.010) down as far as possible onto the mounted support rod (6.2016.050). Make sure while doing so that the indent is facing upwards.
- 2** Fix the 6.1414.030 vessel lid of the KF titration cell (with correctly inserted sealing ring from the 6.1244.040 sealing set) to the support rod.
- 3** Keep the locking lever pressed down and push the vessel lid down.
- 4** Fasten the 6.1415.220 (or 6.1415.250) KF titration cell with a 6.1903.020 (or 6.1903.030) stirring bar inside on the vessel lid. Fold back the holding bracket upwards while doing so. The markings on the vessel lid and on the plastic ring must be aligned above one another. Afterwards, press the holding bracket downwards in order to fix the KF titration cell. The levers of the holding bracket must enclose the pins of the plastic ring on the KF titration cell in order to ensure a secure hold.
- 5** Adjust the height of the KF titration cell by pressing the locking lever. It should almost touch the surface of the stirrer.
- 6** Readjust the clamping ring to the KF titration cell position and screw tight to fix the position of the KF titration cell. Make sure that the nose of the electrode holder is placed in the opening of the clamping ring.

If the height of the KF titration cell has been adjusted correctly, the entire cell can be raised and swiveled as required by pressing the locking lever.

5.4 Connecting MSB devices

In order to connect MSB devices, e.g. dosing device or Remote Box, the Ti-Touch has two connectors at what is referred to as the *Metrohm Serial Bus* (MSB). Various peripheral devices can be connected in sequence (daisy chain) at a single MSB connector (8-pin Mini DIN socket) and be controlled simultaneously by the Ti-Touch. In addition to the connection cable, stirrers and the Remote Box are each equipped with their own MSB socket for this purpose.



NOTE

The additional stirrer must not be connected to the MSB 1!

The following figure provides an overview of the instruments that can be connected to an MSB socket, along with a number of different cabling variations.

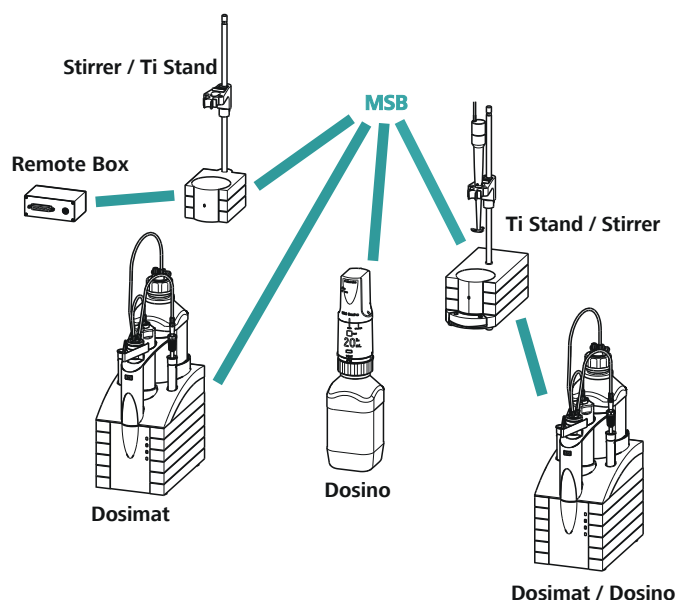

Figure 4 MSB connections

**NOTE**

When connecting MSB devices together, the following must be observed:

- No additional stirrer may be connected to the MSB 1!
- Only one device of the same type may be used at a single MSB connector at one time.
- When making the connection, take care to ensure that the flat part of the MSB plug marked with arrows is pointing in the direction of the marking on the MSB connector (see figure 5, page 16).

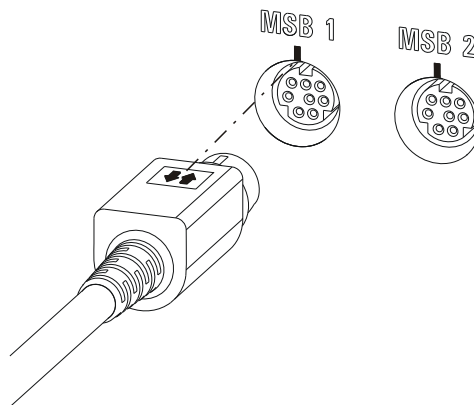

Figure 5 MSB connector

**CAUTION**

Switch off the Ti-Touch before you plug in MSB devices. When it is switched on, the Ti-Touch automatically recognizes which device is connected to which MSB connector. The connected MSB devices are entered automatically in the device manager.

MSB connections can be extended with the 6.2151.010 cable. The maximum connection length permitted is 6 m.

5.4.1 Connecting a dosing device

You can connect two dosing devices to the Ti-Touch.

The types of dosing devices that are supported are:

- 800 Dosino
- 805 Dosimat

Proceed as follows:

- 1 Switch off the Ti-Touch.

- 2 Connect the dosing device connection cable to an MSB connector (2-5) on the rear side of the Ti-Touch.
- 3 Switch on the Ti-Touch.

5.4.2 Connecting an additional stirrer or titration stand

In addition to the built-in magnetic stirrer, you can also use the magnetic stirrers 801 Stirrer, 803 Ti Stand or the 804 Ti Stand with the propeller stirrer 802 Stirrer.

Proceed as follows:

- 1 Switch off the Ti-Touch.
- 2 Connect the connection cable of the magnetic stirrer or of the titration stand to MSB 2 (2-5) on the rear of the Ti-Touch.
- 3 Switch on the Ti-Touch.

5.4.3 Connecting a Remote Box

Instruments that are controlled via remote lines and/or that send control signals via remote lines can be connected via the 6.2148.010 Remote Box. In addition to Metrohm, other instrument manufacturers also use similar connectors that make it possible to connect different instruments together. These interfaces are also frequently given the designations "TTL Logic", "I/O Control" or "Relay Control" and they generally have a signal level of 5 volts.

Control signals are understood to be electrical line statuses or brief (> 200 ms) electrical pulses which display the operational state of an instrument or which trigger or report an event. Sequences on a variety of instruments can thus be coordinated in a single complex automation system. However, no exchange of data is possible.

Proceed as follows:

- 1 Switch off the Ti-Touch.
- 2 Connect the Remote Box connection cable to an MSB connector (2-5) on the rear side of the Ti-Touch.
- 3 Switch on the Ti-Touch.

- 2 Configure the printer in the device manager of the Ti-Touch.

5.5.4 Connecting a balance

If you want to connect a balance to the Ti-Touch you need a USB/RS-232 adapter (6.2148.050).

The following table offers an overview of the balances that you can use together with the Ti-Touch and of which cable you will need for connection to the RS-232 interface:

Balance	Cables
AND ER, FR, FX with RS-232 interface (OP-03)	6.2125.020 + 6.2125.010
Mettler AB, AG, PR (LC-RS9)	In the scope of delivery for the balance
Mettler AM, PM, PE with interface option 016 or Mettler AJ, PJ with interface option 018	6.2146.020 + 6.2125.010 Also from Mettler: ME 47473 adapter and either ME 42500 hand switch or ME 46278 foot switch
Mettler AT	6.2146.020 + 6.2125.010 Also from Mettler: ME 42500 hand switch or ME 46278 foot switch
Mettler AX, MX, UMX, PG, AB-S, PB-S, XP, XS	6.2134.120
Mettler AE with interface option 011 or 012	6.2125.020 + 6.2125.010 Also from Mettler: ME 42500 hand switch or ME 46278 foot switch
Ohaus Voyager, Explorer, Analytical Plus	Cable AS017-09 from Ohaus
Precisa balances with RS-232-C interface	6.2125.080 + 6.2125.010
Sartorius MP8, MC, LA, Genius, Cubis	6.2134.060
Shimadzu BX, BW	6.2125.080 + 6.2125.010



Connect the balance as follows:

- 1** Connect the USB plug of the USB/RS-232 adapter with the USB connector of the Ti-Touch (Type A).
The USB/RS-232 adapter will be recognized automatically and entered in the device manager of the Ti-Touch.
- 2** Connect the RS-232 interface of the USB/RS-232 adapter with the RS-232 interface of the balance (see table for cable).
- 3** Switch on the balance.
- 4** If necessary, switch on the RS-232 interface of the balance.
- 5** Configure the RS-232 interface of the USB/RS-232 adapter in the device manager of the Ti-Touch .
- 6** Enter and configure the balance in the device manager of the Ti-Touch.
- 7** Make sure that the parameters of the USB/RS-232 adapter configured in the device manager match those of the balance.

5.5.5 Connecting a PC keyboard

The PC keyboard is used as an aid for text and numerical input.

Connect the PC keyboard as follows:

- 1** Connect the USB plug of the keyboard with the USB connector of the Ti-Touch (Type A).
- 2** Enter and configure the keyboard in the device manager of the Ti-Touch.

5.5.6 Connecting a barcode reader

The barcode reader is used as an aid for text and numerical input. You can connect a barcode reader with USB interface.

Connect the barcode reader as follows:

- 1** Connect the USB plug of the barcode reader with the USB connector of the Ti-Touch (Type A).

- 2 Enter and configure the barcode reader in the device manager.

Settings on the barcode reader:

Program the barcode reader as follows (also see manual for the barcode reader):

- 1 Switch the barcode reader to programming mode.
- 2 Specify the desired layout for the keyboard (USA, Germany, France, Spain, German-speaking Switzerland).
This setting must match the setting in the device manager.
- 3 Make sure that the barcode reader is set in such a way that Ctrl characters (ASCII 00 to 31) can be sent.
- 4 Program the barcode reader in such a way that the ASCII character 02 (STX or Ctrl B) is sent as the first character. This first character is normally referred to as the "Preamble" or "Prefix Code".
- 5 Program the barcode reader in such a way that the ASCII character 04 (EOT or Ctrl D) is sent as the last character. This last character is normally referred to as the "Postamble", "Record Suffix" or "Postfix Code".
- 6 Exit the programming mode.

5.5.7 Connecting a Sample Processor

If you wish to integrate your Ti-Touch in an automation system, then you can connect the following Sample Processors to the USB connector:

- 814 USB Sample Processor
- 815 Robotic USB Sample Processor XL
- 810 Sample Processor (from firmware version 5.915.0040)

To connect a Sample Processor, you need the 6.2151.000 controller cable.

Connect the Sample Processor as follows:

- 1 Connect the Sample Processor to the power grid.
- 2 Connect the Sample Processor to the Ti-Touch with the controller cable.

The Sample Processor will be recognized automatically and entered in the device manager of the Ti-Touch.

**NOTE**

The plug on the controller cable is protected against accidental disconnection by means of a pull-out protection feature. If you wish to pull out the plug, you first need to pull back the outer plug sleeve marked with arrows.

- 3 Configure the Sample Processor in the device manager.

5.5.8 Connecting the 885 Compact Oven SC

**NOTE**

In order for the 885 Compact Oven SC to be controlled with the 915 KF Ti-Touch, the following firmware versions must be installed on the instruments as a minimum requirement:

- 915 KF Ti-Touch 5.915.0045
- 885 Compact Oven SC 5.885.0013

The 885 Compact Oven SC is connected via the USB interface. The 6.2151.110 USB cable is required for this.

If the USB interface on the 915 KF Ti-Touch is also needed for other USB devices (USB flash drive, USB keyboard, USB/RS-232 adapter for balance), use a USB hub with its own power supply.

Connect the 885 Compact Oven SC as follows:

- 1 Switch off the 915 KF Ti-Touch.
- 2 Connect the 885 Compact Oven SC to the Ti-Touch using a USB cable.
- 3 Switch on the 885 Compact Oven SC.
- 4 Switch on the 915 KF Ti-Touch.

**NOTE**

When the 915 KF Ti-Touch is started, the 885 Compact Oven SC is added to the device manager and the settings from the device manager are transferred to the instrument.

The switch-on sequence must be strictly observed with the 885 Compact Oven SC.

- 5 Configure the 885 Compact Oven SC in the device manager.

5.6 Setting up the titration vessel

The tutorial for the 915 KF Ti-Touch describes in detail how to set up the Karl Fischer titration cell and what you need to observe while doing so.

5.7 Connecting sensors

5.7.1 General

The measuring interface includes one measuring input (**Pol.**) for a polarizable electrode and one measuring input (**Temp.**) for a temperature sensor (Pt1000 or NTC).

5.7.2 Connecting a polarizable electrode

Connect the polarizable electrode as follows:

- 1 Plug the electrode plug into the **Pol.** socket of the Ti-Touch.

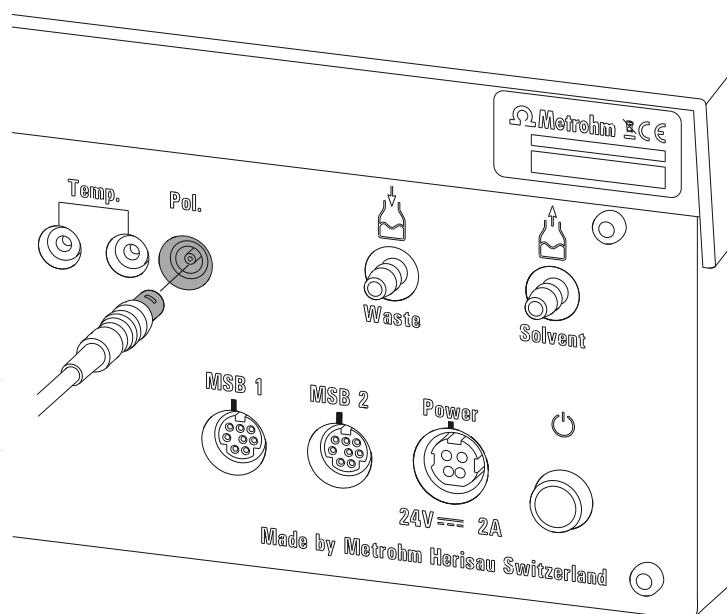

Figure 6 Connecting a polarizable electrode



NOTE

The electrode cable is protected against accidental disconnection of the cable by means of a pull-out protection. If you wish to pull out the plug again, you first need to pull back the outer plug sleeve.

5.7.3 Connecting the temperature sensor

A temperature sensor of the Pt1000 or NTC type can be connected to the **Temp.** connector.

Connect the temperature sensor as follows:

- 1 Plug the temperature sensor plugs into the **Temp.** sockets of the Ti-Touch.

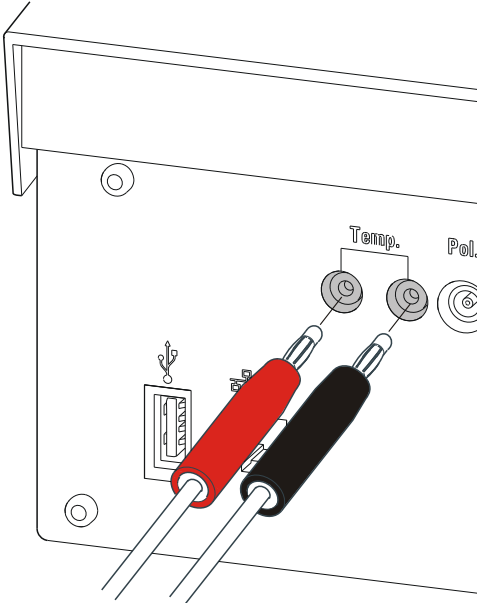

Figure 7 Connecting the temperature sensor



NOTE

The red plug must always be plugged into the red socket for the purpose of shielding against disruptions.

5.8 Connecting the Ti-Touch to a network

The 915 KF Ti-Touch has a network connection (Ethernet). This can be used to integrate your Ti-Touch in your network. You can, for example, store data on a PC within the network or print reports on a network printer. You will find information as to which settings are necessary for the network connection in the *Device manager* chapter contained in the more detailed manual.

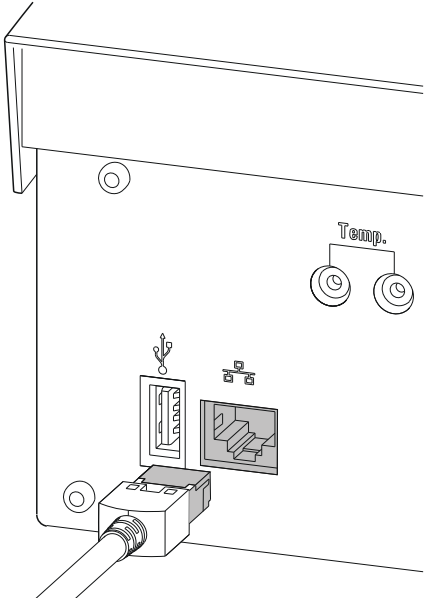

Figure 8 Connecting the Ti-Touch to a network

6 Operation

6.1 Switching the instrument on and off

Switching on the instrument



CAUTION

Peripheral devices (e.g., printers, 885 Compact Oven SC, etc) must be connected and switched on before you switch on the 915 KF Ti-Touch.



NOTE

English is set as the default dialog language when the instrument is switched on for the first time.

Information about changing the dialog language can be found in the chapter *Selecting the dialog language* of the detailed manual.

Proceed as follows:

- 1 ▪ Press the power switch on the left-hand side of the back panel of the 915 KF Ti-Touch.
The 915 KF Ti-Touch is initialized. A system test is performed. This process takes some time.

**NOTE**

If a buret unit is connected, then a request appears to carry out the **Prepare** function:

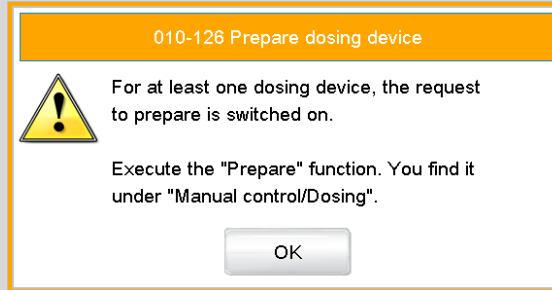

All tubings and the cylinder are rinsed with the **Prepare** function.

The preparing of the buret unit is described in the chapter *Manual control* of the detailed manual.

- Confirm the message with **[OK]**.

The main dialog is displayed:

Switching off the instrument

**CAUTION**

The 915 KF Ti-Touch must be switched off by pressing the power switch on the rear of the instrument before the electricity supply is interrupted. If this is not done, then there is a danger of data loss.

Proceed as follows:

- 1 Press the power switch on the left-hand side of the back panel of the 915 KF Ti-Touch.

The current data is saved and the system is shut down. This process takes just a short time. At the same time, all other instruments connected to the 915 KF Ti-Touch via a USB cable are also being switched off (except the 885 Compact Oven SC).

6.2 Fundamentals of operation

6.2.1 Touch-sensitive screen

The entire 915 KF Ti-Touch user interface is touch-sensitive. Simply touch a few of the buttons on the interface to learn how a touch-sensitive screen reacts. You can always return to the main dialog by touching [].

In order to enable an element on the 915 KF Ti-Touch user interface, just touch the screen with your fingertip, the eraser of a pencil or a stylus (special tool for operating instruments with touch-sensitive screens).



CAUTION

Never touch the touch screen with a pointed or sharp object such as a ballpoint pen.





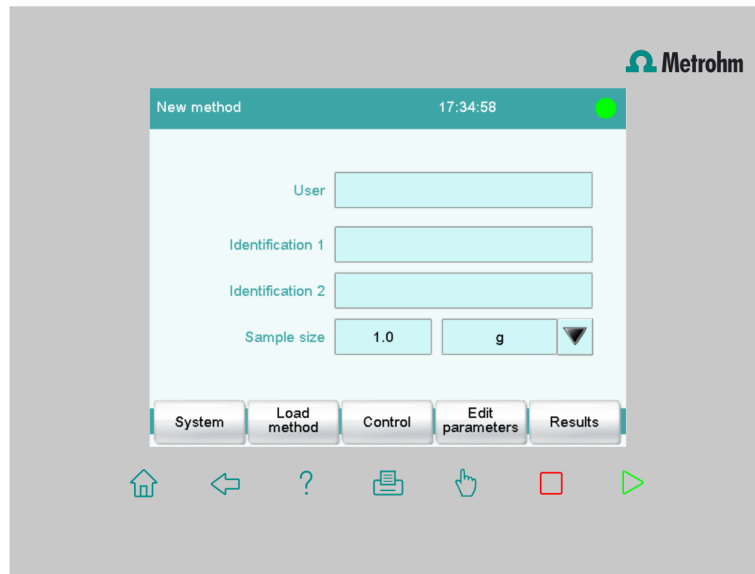

In the default setting, the software is configured in such a way that an acoustic signal will be generated every time an active control is touched. This setting can be deactivated in the system settings.

6.2.2 Display elements and controls



The following display elements and controls are available:



Table 1 Fixed keys which are always available

	[Home] always opens the main dialog.
	[Back] saves the entry and opens the next-higher dialog page.
	[Help] opens the online help for the dialog displayed.
	[Print] opens the printing dialog.
	[Manual] opens the manual control.
	[Stop] cancels the running determination.
	[Start] starts a determination.

The file name of the loaded method, the time and the system status are displayed in the main dialog in the **Title bar**.

In the other dialogs, the title bar shows the headings of the next upper level and of the displayed dialog. This is an aid for orientation during navigation through the user dialog.

Table 2 Screen elements

	Buttons open a new dialog when they are tapped.
	

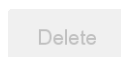

Inactive buttons with gray lettering indicate that the respective function is not available at the moment.

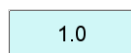

Input fields open an input dialog when tapped.



Tapping on the **selection symbol** opens a selection list.



A **check box** can also be activated or deactivated by tapping on it.

6.2.3 Status display

The current status of the system is displayed in the upper right-hand corner of the title bar.

Table 3 Status displays



The instrument is in normal status.



The working medium is being conditioned.



Conditioning has been paused.



The working medium is conditioned.



A method has been started.



A method has been paused.



An action has been started in manual control.

6.2.4 Entering text and numbers

In the editing dialog for text or numerical input, enter the individual characters by tapping in the input field. The following functions are available:

Text editor



Table 4 Editing functions

Editing function	Description
[OK]	The modification is applied and the editing dialog is exited.
[Cancel]	The editing dialog is exited without applying the modification.
[Delete entry]	The content of the input field is deleted completely.
[□]	The character in front of the cursor is deleted.
[⇐]	The cursor within the input field is shifted to the left by one character.
[⇒]	The cursor within the input field is shifted to the right by one character.
[a...z]	The lower-case letters are displayed. The label changes to [A...Z]. The upper-case letters are displayed again by tapping.
[0-9]	Numbers and mathematical characters are displayed.
[Special characters]	Special characters are displayed. You can use the button [More] to navigate through all available characters.

Number editor

Edit command / Stop conditions

Stop time s

Input:
1 ... 999999

Default value:
off

7	8	9	off
4	5	6	R1 ▼
1	2	3	
0	+/-	.	

Cancel Delete entry OK

Table 5 Editing functions

Editing function	Description
[OK]	The modification is applied and the editing dialog is exited.
[Cancel]	The editing dialog is exited without applying the modification.
[Delete entry]	The content of the input field is deleted completely.
[off]	If not only numbers but also special values (e.g., off) can be entered, then the corresponding buttons will be shown to the right of the numerical keypad.
[R1]	For many parameters, a result previously defined in the method can also be entered in place of a number. You will find precise information concerning this in the Appendix of the detailed manual. You can select the result variable by touching [R1] .



NOTE

A commercially available USB keyboard can be connected to make text and numerical input easier.

The key assignment is described in the chapter *Device manager* of the detailed manual.

7 Maintenance

Maintenance

The electronic and mechanical functional groups of Metrohm instruments can and should be checked by specialist personnel from Metrohm as part of a regular preventive maintenance schedule. Please ask your local Metrohm representative regarding the precise terms and conditions involved in concluding a corresponding maintenance agreement.

For detailed information on this topic, please visit www.metrohm.com.

Cleaning

Cleaning the surfaces of the instrument

Prerequisites

- The instrument is disconnected from the power grid.

1 Clean the surfaces with a damp cloth.

 **NOTE**

Water or ethanol can be used as a cleaning medium.

 **NOTE**

The connectors at the rear of the instrument must only be cleaned with a dry cloth.

Index

800 Dosino	16
801 Stirrer	17
803 Ti Stand	17
804 Ti Stand	17
805 Dosimat	16

B

Balance	19
Barcode reader	
Connect	20

C

Connect	
Balance	19
Barcode reader	20
Dosing device	16
MSB devices	15
PC keyboard	20
Power supply unit	12
Printer	18
Remote Box	17
Sample Processor	21
Stirrer or titration stand	17
USB devices	18
USB hub	18

D

Dosing device	
Connect	16

E

Electrostatic charge	8
Ethernet connector	25

F

Fixed key	10
-----------------	----

I

Installation	
Set up instrument	12
Instrument	
Switch off	28
Switch on	27

K

Keyboard	
Connect	20
KFT	2

M

Magnetic stirrer	
Connect	17
Metrohm Serial Bus MSB, see also	
"MSB"	15
MSB	
Connect devices	15

N

Network connection	25
Numerical input	32

O

Operation	
General	29

P

PC keyboard	
Connect	20

Power supply unit	
Connect	12
Printer	18

R

Remote Box	
Connect	17

S

Safety	6
Safety instructions	7
Sample Processor	
Connect	21
Service	7
Set up instrument	12
Stirrer	
Connect	17
Supply voltage	8
Switch off	28
Switch on	27

T

Text input	32
Titration mode	
KFT	2
Titration stand	17
Connect	17
Touch screen	29

U

USB	
Connect devices	18
USB hub	
Connect	18