

907 Titrande



Manual

8.907.8003EN / v9 / 2026-01-09



Metrohm AG
CH-9100 Herisau
Switzerland
+41 71 353 85 85
info@metrohm.com
www.metrohm.com

907 Titrande

Manual

Technical Communication
Metrohm AG
CH-9100 Herisau

This documentation is protected by copyright. All rights reserved.

This documentation is an original document.

This documentation has been prepared with great care. However, errors can never be entirely ruled out. Please send comments regarding possible errors to the address above.

Disclaimer

Deficiencies arising from circumstances that are not the responsibility of Metrohm, such as improper storage or improper use, etc., are expressly excluded from the warranty. Unauthorized modifications to the product (e.g., conversions or attachments) exclude any liability on the part of the manufacturer for resulting damage and its consequences. Instructions and notes in the Metrohm product documentation must be strictly followed. Otherwise, Metrohm's liability is excluded.

Table of contents

1	Introduction	1
1.1	The Titrand system	1
1.2	Device description	2
1.3	Titration modes – Measuring modes – Dosing commands	3
1.4	Displaying accessories	5
1.5	Symbols and conventions	6
2	Safety	7
2.1	Intended use	7
2.2	Responsibility of the operator	7
2.3	Personnel requirement	8
2.4	Safety instructions	8
2.4.1	Electrical safety	8
2.4.2	Tubing and capillary connections	9
2.4.3	Flammable solvents and chemicals	9
3	Overview of the device	10
4	Installation	12
4.1	Setting up the device	12
4.1.1	Packaging	12
4.1.2	Checks	12
4.1.3	Location	12
4.2	Connecting a controller	12
4.2.1	Operation	12
4.3	Connecting MSB devices	17
4.3.1	Connecting a dosing device	18
4.3.2	Connecting a stirrer or titration stand	19
4.3.3	Connecting a Remote Box	20
4.4	Connecting USB devices	21
4.4.1	General	21
4.4.2	Connecting a USB hub	22
4.4.3	Connecting a printer	22
4.4.4	Connecting a balance	23
4.4.5	Connecting a keyboard (only for operation with Touch Control)	24
4.4.6	Connecting a barcode reader	25



4.5	Setting up the titration vessel	26
4.5.1	General	26
4.5.2	Titration vessel for volumetric KF titration	27
4.6	Connecting sensors	31
4.6.1	Connecting a pH, metal or ion-selective electrode	31
4.6.2	Connecting a reference electrode	31
4.6.3	Connecting a polarizable electrode	32
4.6.4	Connecting a temperature sensor or an electrode with integrated temperature sensor	32
4.6.5	Connecting the iConnect	33
4.6.6	Differential potentiometry	36
5	Karl Fischer titration	37
5.1	Volumetric titration	37
5.1.1	Principle of the volumetric Karl Fischer titration	37
5.1.2	Endpoint determination	37
5.1.3	Karl Fischer reagents	38
5.1.4	Application of the Karl Fischer titration	38
5.1.5	Working with water standards	38
5.1.6	Sample addition	40
5.1.7	Optimum working conditions	42
6	Operation and maintenance	44
6.1	General notes	44
6.1.1	Care	44
6.1.2	Maintenance by Metrohm Service	44
7	Troubleshooting	45
7.1	General	45
7.2	Karl Fischer titration	45
7.2.1		45
7.3	SET titration	47
7.3.1		47
8	Appendix	48
8.1	Remote interface	48
8.1.1	Pin assignment of the remote interface	48
9	Recycling and disposal	52
10	Technical specifications	53
10.1	Measuring interface	53
10.1.1	Potentiometry	53
10.1.2	Temperature	53
10.1.3	Polarizer	54
10.2	Power connection	55



10.3	Ambient conditions	55
10.4	Reference conditions	55
10.5	Dimensions	56
10.6	Interfaces	56
	Index	57

1 Introduction

1.1 The Titrando system

The Titrando is the heart of the modular Titrando system. Operation is carried out either by a Touch Control with a touch-sensitive screen ("stand-alone titrator") or by a computer with a corresponding software.

A Titrando system can contain numerous, various kinds of devices. The following figure provides an overview of the peripheral devices you can connect to the 907 Titrando.

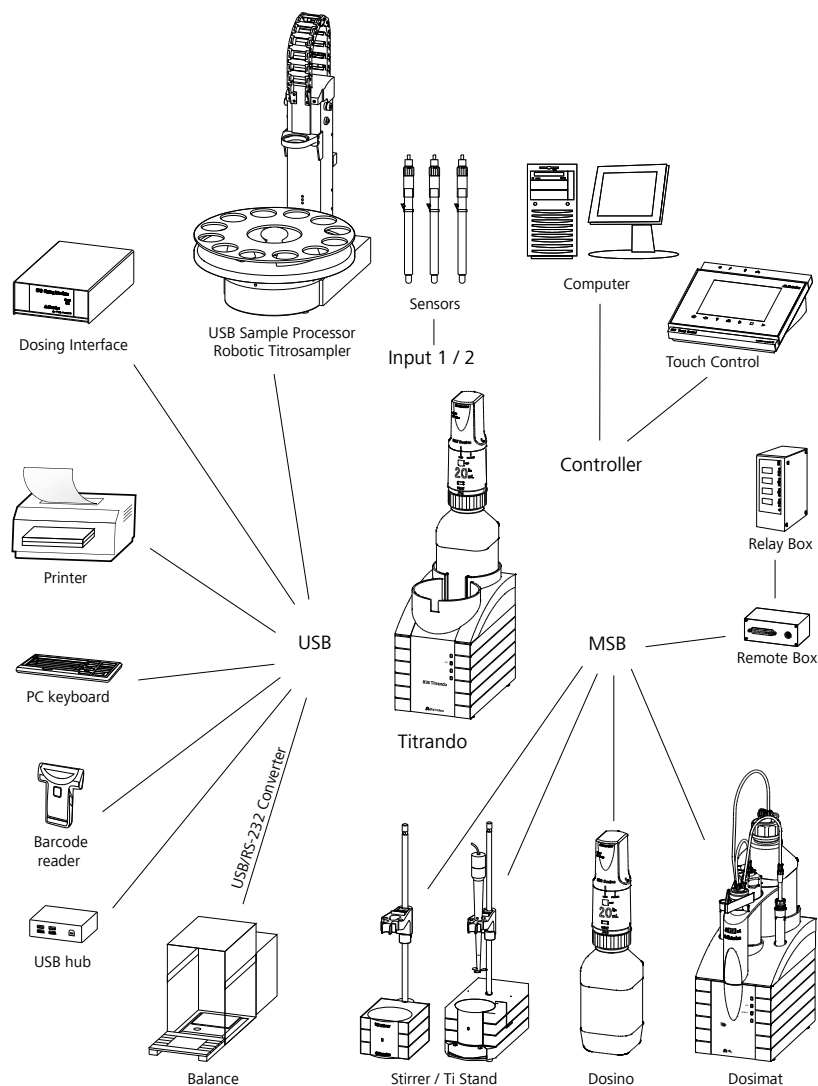

Figure 1 The Titrando system



Up to 3 control instruments (Titrande, Dosing Interface, USB Sample Processor, etc.) can be controlled via USB connection during operation with the 900 Touch Control.

You can request information on special applications in the "Application Bulletins" and "Application Notes", available free of charge via the regional Metrohm representative. Various monographs on the subjects of titration techniques and electrodes are also available.

Updating the device software is described in the help of the corresponding PC software.

1.2 Device description

The 907 Titrande has the following characteristics:

- **Operation**
Operation is carried out by means of a touch-sensitive Touch Control or with a high-performance PC software.
- **MSB connectors**
4 MSB connectors (Metrohm Serial Bus) for connecting dosing devices (Dosimat or Dosino), stirrers, titration stands, and Remote Boxes.
- **USB connectors**
Two USB connectors, through which devices such as printers, PC keyboards, barcode readers or additional control devices (USB Sample Processor, Titrande, Dosing Interface, etc.) can be connected.
- **Measuring interface**
Depending on the model version, one or two measuring interface(s).
Each measuring interface has one measuring input each for:
 - a potentiometric electrode (pH, metal or ion-selective electrode)
 - a separate reference electrode
 - a temperature sensor (Pt1000 or NTC)
 - a polarizable electrode
 - an iConnect (measuring interface for electrodes with integrated data chip, so-called iTrodes)

1.3 Titration modes – Measuring modes – Dosing commands

The 907 Titrande supports the following titration modes, measuring modes and dosing commands:

- **DET**
Dynamic equivalence point titration. The reagent is added in variable volume steps.
Measuring modes:
 - **pH** (pH measurement)
 - **U** (potentiometric voltage measurement)
 - **Ipol** (voltametric measurement with selectable polarization current)
 - **Upol** (amperometric measurement with selectable polarization voltage)
- **MET**
Monotonic equivalence point titration. The reagent is added in constant volume steps.
Measuring modes:
 - **pH** (pH measurement)
 - **U** (potentiometric voltage measurement)
 - **Ipol** (voltametric measurement with selectable polarization current)
 - **Upol** (amperometric measurement with selectable polarization voltage)
- **SET**
Endpoint titration at one or two specified endpoints.
Measuring modes:
 - **pH** (pH measurement)
 - **U** (potentiometric voltage measurement)
 - **Ipol** (voltametric measurement with selectable polarization current)
 - **Upol** (amperometric measurement with selectable polarization voltage)
- **STAT**
Endpoint titration during which the measured value is kept constant.
Measuring modes:
 - **pH** (pH measurement)
 - **U** (potentiometric voltage measurement)

1.4 Displaying accessories

Up-to-date information on the scope of delivery and on optional accessories can be found on the Metrohm website.

1 Searching for a product on the website

- Go to <https://www.metrohm.com>.
- Click on .
- Enter the article number of the product (e.g. **2.1001.0010**) into the search field and press **[Enter]**.

The search result is displayed.

2 Displaying product information

- To display the products matching the search term, click on **Product models**.
- Click on the desired product.

Detailed information regarding the product is displayed.

3 Displaying accessories and downloading the accessories list

- To display the accessories, scroll down to **Accessories and more**.
 - The **scope of delivery** is displayed.
 - Click on **[Optional parts]** for the optional accessories.
- To download the accessories list, click on **[Download accessories PDF]** under **Accessories and more**.









NOTE

Metrohm recommends keeping the accessories list for reference purposes.

1.5 Symbols and conventions

The following symbols and formatting may appear in this documentation:

<i>(5-12)</i>	Cross-reference to figure legend The first number refers to the figure number, the second to the device part in the figure.
1	Instruction step Perform the steps one after the other.
Method	Dialog text, parameter in the software
File ► New	Menu or menu item
[Continue]	Button or key
	WARNING This symbol draws attention to a possible life-threatening hazard or risk of injury.
	WARNING This symbol draws attention to a possible hazard due to electrical current.
	WARNING This symbol draws attention to a possible hazard due to heat or hot instrument parts.
	WARNING This symbol draws attention to a possible biological hazard.
	WARNING Warning of optical radiation
	CAUTION This symbol draws attention to possible damage to devices or device parts.
	NOTICE This symbol highlights additional information and tips.

2 Safety



WARNING

Operate this device only according to the information contained in this documentation.

This device left the factory in a flawless state in terms of technical safety. To maintain this state and ensure non-hazardous operation of the device, the following instructions must be observed carefully.

2.1 Intended use

2.2 Responsibility of the operator

The operator is responsible for the following tasks to ensure the safe operation of the product:

- Check the condition of the product before use
- Ensure that the operating values and limit values specified in the technical specifications are observed.
- Maintain and clean the product regularly
- Remedy defects and malfunctions immediately



NOTE

The product may be used only when its status is perfect.

- Train staff on basic occupational safety and accident prevention regulations for chemical laboratories and ensure that these regulations are complied with.
- Train personnel in the use of the product according to the user documentation (e.g., install, operate, eliminate faults).
- Provide personal protective equipment (e.g., protective glasses, gloves).
- Provide suitable tools and equipment to execute the work safely.

Supply voltage



WARNING

An incorrect supply voltage can damage the device.

Operate this device only with a supply voltage specified for it (refer to the rear of the device).

Protection against electrostatic charges



WARNING

Electronic components are sensitive to electrostatic charges and can be destroyed by discharges.

Do not fail to pull the power cord out of the power socket before setting up or disconnecting electrical plug connections at the rear of the device.

2.4.2 Tubing and capillary connections



CAUTION

Leaks in tubing connections and capillary connections are a safety risk. Tighten all connections well by hand. Avoid applying excessive force to tubing connections. Damaged tubing ends lead to leakage. Suitable tools can be used for disconnecting connections.

The leak-tightness of the connections must be checked regularly. If the device is used mainly in unattended operation, then weekly inspections are mandatory.

2.4.3 Flammable solvents and chemicals



WARNING

All relevant safety measures are to be observed when working with flammable solvents and chemicals.

- Set up the device in a well-ventilated location (e.g., fume cupboard).
- Keep all sources of ignition far from the workplace.
- Clean up spilled liquids and solids immediately.
- Follow the safety instructions of the chemical manufacturer.

3 Overview of the device

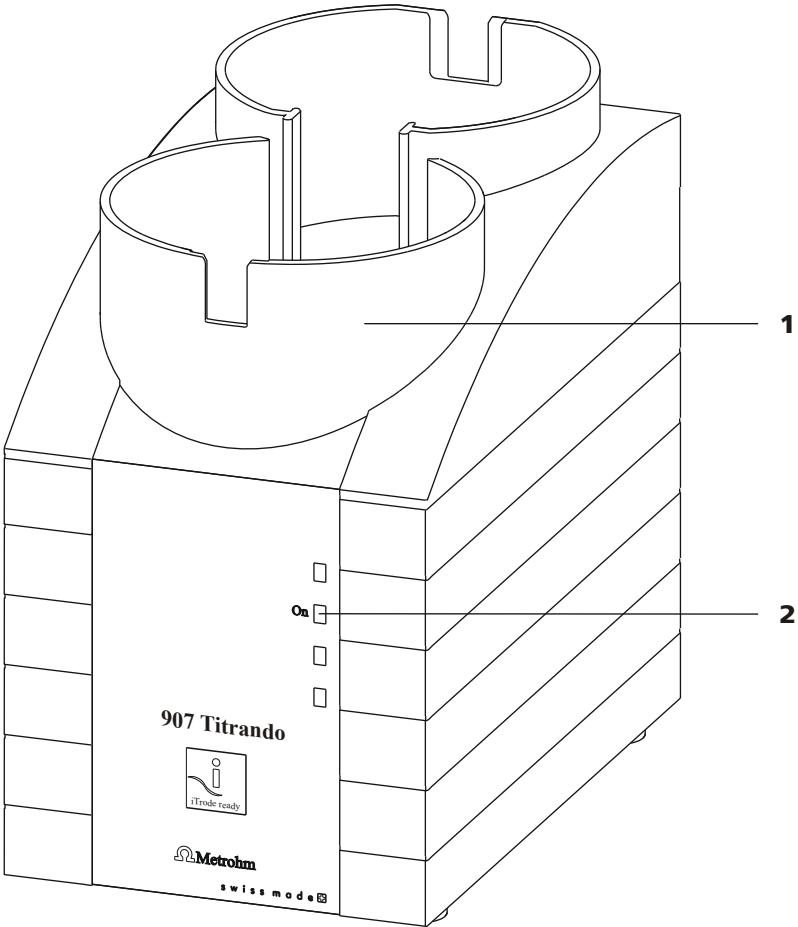

Figure 2 Front 907 Titrandometer

1 Bottle holder
With holding clamps, for two reagent bottles.

2 "On" LED
Lights up when the Titrandometer is ready for operation.

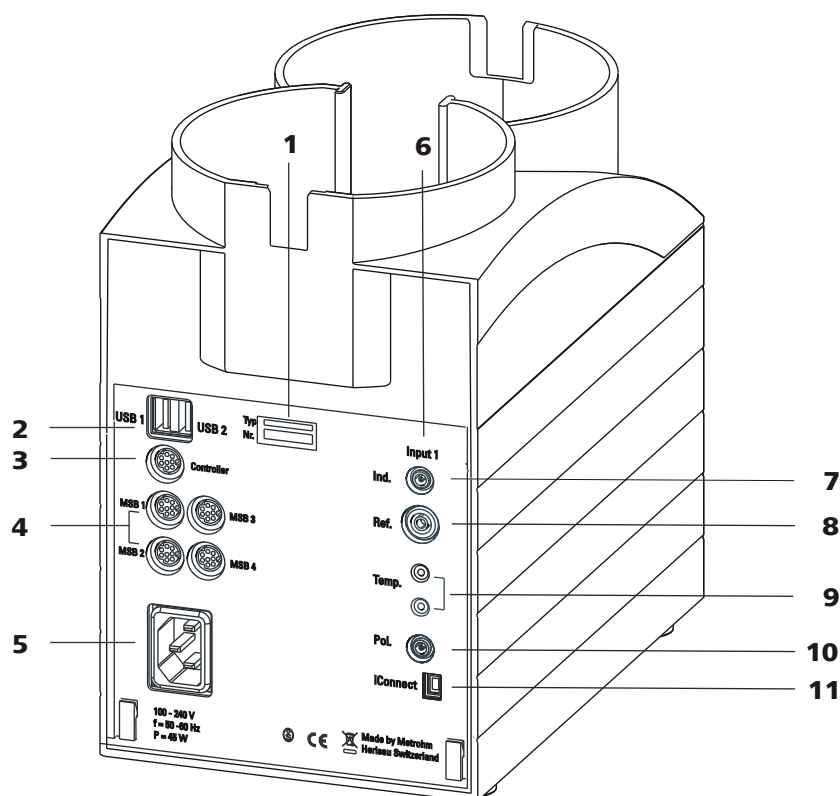

Figure 3 Rear 907 Titrand

<p>1 Type label Contains specifications concerning supply voltage, instrument type and serial number.</p>	<p>2 USB connector (USB 1 and USB 2) USB ports (type A) for connecting printer, keyboard, barcode reader, additional Titrandos, USB Sample Processor, etc.</p>
<p>3 Connector (Controller) For connecting a Touch Control or a PC with installed PC software. Mini DIN, 9-pin.</p>	<p>4 MSB connector (MSB 1 to MSB 4) Metrohm Serial Bus. For connecting external dosing devices, stirrers or Remote Boxes. Mini DIN, 9-pin.</p>
<p>5 Power socket</p>	<p>6 Measuring interface 1 (Input 1)</p>
<p>7 Electrode connector (Ind.) For connecting pH, metal or ion-selective electrodes with integrated or separate reference electrode. Socket F.</p>	<p>8 Electrode connector (Ref.) For connecting reference electrodes, e.g. Ag/AgCl reference electrode. Socket B, 4 mm.</p>
<p>9 Temperature sensor connector (Temp.) For connecting temperature sensors (Pt1000 or NTC). Two B sockets, 2 mm.</p>	<p>10 Electrode connector (Pol.) For connecting polarizable electrodes, e.g. double Pt wire electrodes. Socket F.</p>
<p>11 Electrode connector (iConnect) For connecting electrodes with integrated data chip (iTrodes).</p>	

4.2.1.1 Connecting a Touch Control



NOTE

The plug is protected against accidental disconnection of the cable by means of a pull-out protection feature. If you wish to pull out the plug, you first need to pull back the outer plug sleeve marked with arrows.

- 1 ▪ Insert the plug of the Touch Control connection cable into the **Controller** socket.

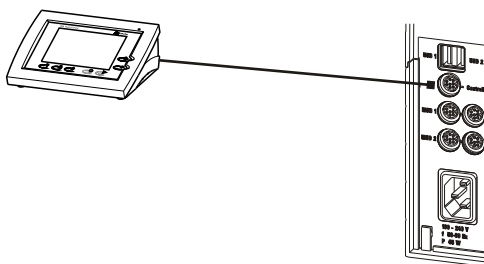

Figure 4 Connecting the Touch Control

- 2 ▪ Connect the MSB devices (*see chapter 4.3, page 17*).
 - Connect the USB devices (*see chapter 4.4, page 21*).
- 3 ▪ Connect the Titrande to the power grid (*see chapter 4.2.1.2, page 14*).
- 4 ▪ Switch on the Touch Control.

The Touch Control power supply is supplied through the Titrande. Automatic system tests are performed on both devices at the time of switch-on. The **On** LED on the front of the Titrande lights up when the system test has been completed and the device is ready for operation.



CAUTION

The Touch Control must be shut down properly by deactivation with the power switch on the rear of the device before the power supply is interrupted. If this is not done, then there will be a danger of data loss. Because of the fact that the power supply for the Touch Control is provided through the Titrande, you must never disconnect the Titrande from the power grid (e.g. by deactivating with a connector strip) before you have deactivated the Touch Control.

If you would prefer not to position the Touch Control directly next to the Titrando, then you can lengthen the connection with the 6.2151.010 cable. The maximum connection length permitted is 5 m.

4.2.1.2 Connecting the instrument to the power grid



WARNING

Electric shock from electrical potential

Risk of injury by touching live components or through moisture on live parts.

- Never open the housing of the instrument while the power cord is still connected.
- Protect live parts (e.g. power supply unit, power cord, connection sockets) against moisture.
- Unplug the power plug immediately if you suspect that moisture has gotten inside the instrument.
- Only personnel who have been issued Metrohm qualifications may perform service and repair work on electrical and electronic parts.

Connecting the power cord

Accessories

Power cord with the following specifications:

- Length: max. 2 m
- Number of cores: 3, with protective conductor
- Instrument plug: IEC 60320 type C13
- Conductor cross-section 3x min. 0.75 mm² / 18 AWG
- Power plug:
 - according to customer requirement (6.2122.XX0)
 - min. 10 A



NOTE

Do not use a not permitted power cord!

1 Plugging in the power cord

- Plug the power cord into the instrument's power socket.
- Connect the power cord to the power grid.

4.2.1.3 Connecting a computer

The 907 Titrande requires a USB connection to a computer in order to be able to be controlled by a computer software. Using a 6.2151.000 controller cable, the instrument can be connected directly, either to a USB port on a computer, to a connected USB hub or to a different Metrohm control instrument.

You need administrator rights for the installation of driver software and control software on your computer.

Cable connection and driver installation

A driver installation is required in order to ensure that the 907 Titrande is recognized by the computer software. To accomplish this, you must comply with the procedures specified. The following steps are necessary:

1 Installing the software

- Insert the installation CD of the computer software and carry out the instructions of the installation program.
- Exit the program if you have started it after the installation.

2 Establishing the cable connections

- Connect all peripheral devices to the instrument, *see chapter 4.3, page 17*.
- Connect the instrument to the power grid if you have not already done this (*see chapter 4.2.1.2, page 14*).
The "On" LED on the 907 Titrande is not yet illuminated!
- Connect the instrument to a USB connector (type A) of your computer (*see manual of your computer*). The 6.2151.000 cable is used for this purpose.

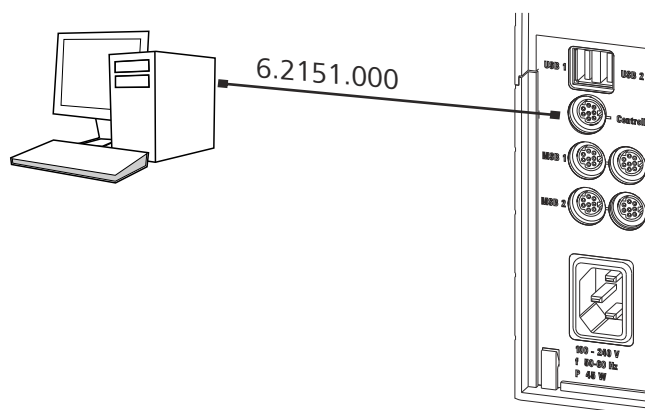

Figure 5 Connecting the computer

The instrument is recognized. Depending on the version of the Windows operating system used, the driver installation proceeds dif-

4.3 Connecting MSB devices

In order to connect MSB devices, e.g., stirrers or dosing devices, Metrohm devices are equipped with up to a maximum of 4 connectors on what is referred to as the *Metrohm Serial Bus* (MSB). Various kinds of peripheral devices can be connected in sequence (in series, as a "daisy chain") at a single MSB connector (8-pin Mini DIN socket) and controlled simultaneously by the respective control instrument. In addition to the connection cable, stirrers and the Remote Box are each equipped with their own MSB socket for this purpose.

The following figure provides an overview of the instruments that can be connected to an MSB socket, along with a number of different cabling variations.

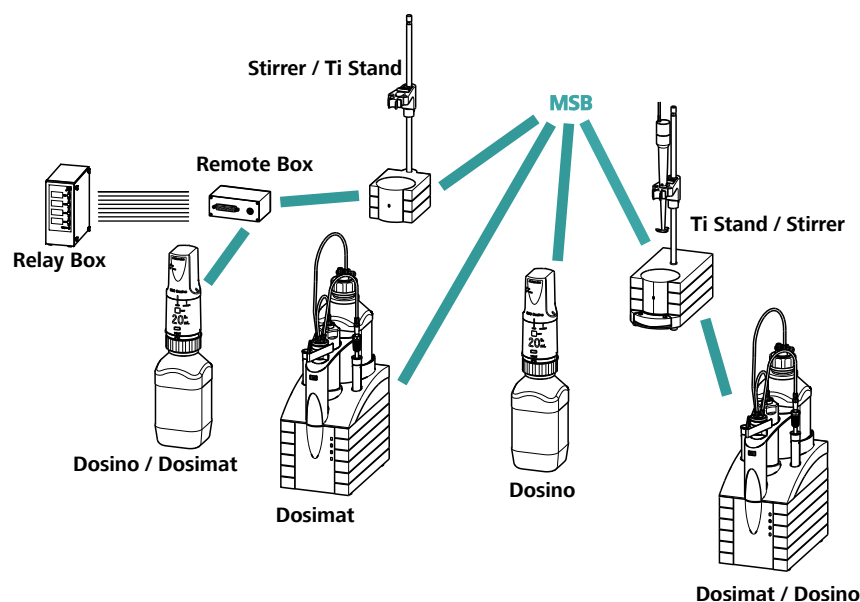

Figure 6 MSB connections

The control instrument determines which peripheral devices are supported.



NOTE

When connecting MSB devices together, the following must be observed:

- Only one device of the same type can be used at a single MSB connector at one time.
- Dosing devices of the 700 Dosino and 685 Dosimat plus type cannot be connected together with other MSB devices on a shared connector. These dosing devices must be connected separately.



CAUTION

Exit the control software before you plug in MSB devices. When it is switched on, the control instrument automatically recognizes which device is connected to which MSB connector. The operating unit or the control software enters the connected MSB devices into the system configuration (device manager).

MSB connectors can be extended with the 6.2151.010 cable. The maximum connection length permitted is 15 m.

4.3.1 Connecting a dosing device

Four dosing devices can be connected to the instrument (**MSB 1 to MSB 4**).

The types of dosing devices that are supported are:

- 800 Dosino
- 700 Dosino
- 805 Dosimat
- 685 Dosimat plus

Connecting a dosing device

1 Connecting a dosing device

- Exit the control software.
- Connect the connection cable of the dosing device to 1 of **MSB** sockets on the rear of the control instrument.
- Start the control software.

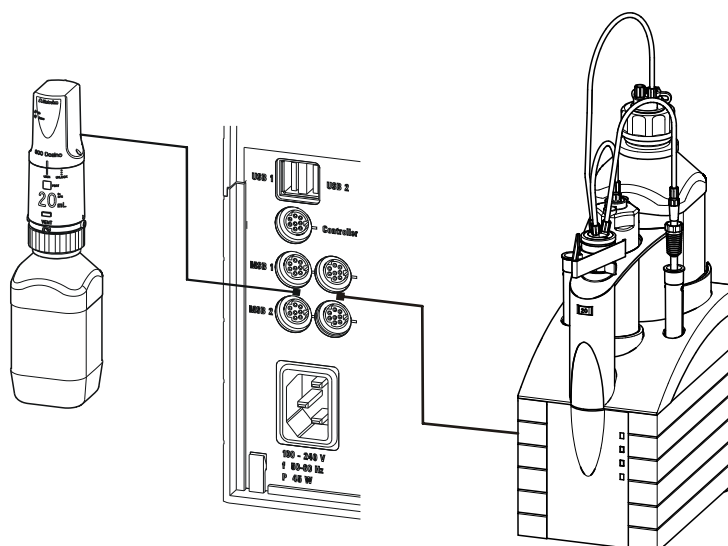

Figure 7 Connecting a dosing device

4.3.2 Connecting a stirrer or titration stand

You can use the following devices:

These devices have a built-in magnetic stirrer (stirring "from below"):

- 801 Stirrer
- 803 Ti Stand

This device has no built-in magnetic stirrer (stirring "from above"):

- 804 Ti Stand with propeller stirrer 802 Stirrer

Connecting the stirrer or titration stand

- 1 Exit the control software.
- 2 Connect the connection cable of the magnetic stirrer or titration stand to an **MSB** socket on the rear of the control instrument.
804 Ti Stand only: Connect the propeller stirrer to the stirrer connector (socket with stirrer symbol) of the titration stand.
- 3 Start the control software.

cise information concerning the pin assignment of the interface on the Remote Box in the *Appendix*.

Control signals are understood to be electrical line statuses or electrical pulses (> 200 ms) which display the operating status of an instrument or which trigger or report an event. Runs on a variety of instruments and can thus be coordinated in a single complex automation system. However, no data exchange is possible.

Connecting the Remote Box

- 1 Exit the control software.
- 2 Connect the connection cable of the Remote Box to an **MSB** socket on the rear of the control instrument.
- 3 Start the control software.

4

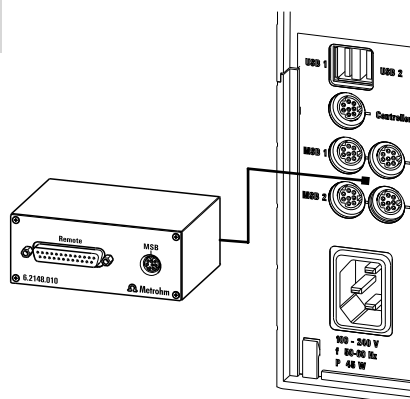

Figure 10 Connecting the Remote Box

4.4 Connecting USB devices

4.4.1 General

The 907 Titrando has 2 USB connectors (type A sockets) for peripheral devices with USB interfaces. The Titrando functions as a USB hub (distributor), no matter how it is operated. If you wish to connect more than 2 devices to the USB, you can also use an additional, commercially available USB hub.

**CAUTION**

If you operate the 907 Titrandò with the aid of the Touch Control, then take care to ensure that the Touch Control is switched off when you set up or disconnect connections between the various devices. If you use a computer software to control the 907 Titrandò, then you should exit the program before you set up or disconnect the USB connections.

4.4.2 Connecting a USB hub

If you wish to connect more than 2 devices to the USB connector of the 907 Titrandò, then you can also use an additional commercially available USB hub (distributor). If you operate the 907 Titrandò with the help of the Touch Control, then you should use a USB hub with its own energy supply.

- 1 Switch off the Touch Control and/or exit the computer software.
- 2 With the aid of the 6.2151.020 cable, connect the USB connector of the 907 Titrandò (type A) with the USB connector of the hub (type B, see manual for the hub).

- 3 Switch on the Touch Control.

The USB hub is recognized automatically.

4.4.3 Connecting a printer

Printers that are connected to the 907 Titrandò with Touch Control must meet the following requirements:

- Printer languages: HP-PCL (PCL 3 to 5, PCL 3GUI), Canon BJI Commands or Epson ESC P/2
- Printer resolution: 300 dots/inch or 360 dots/inch (Epson)
- Paper size: A4 or Letter, single-sheet feed.

- 1 Switch off the Touch Control.
- 2 With the aid of the 6.2151.020 cable, connect the USB connector of the 907 Titrandò (type A) with the USB connector of the printer (type B, see manual for the printer).
- 3 Switch on the printer first, then the Touch Control.

- 4** Configure the printer in the device manager of the Touch Control (see Touch Control manual).

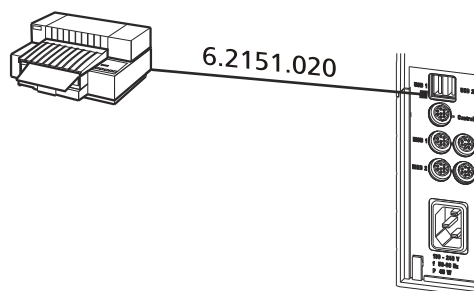

Figure 11 Connecting a printer

4.4.4 Connecting a balance

- Operation with a computer software:
 - Connect the balance directly to the serial connector (COM) of the computer. This is usually 9-pin and marked with the symbol **IOIOI**.
- Operation with Touch Control:
 - You will need the 6.2148.050 USB/RS-232 adapter to connect a balance.

The following table offers an overview of the balances that you can use together with the 907 Titrando and of which cable you will need for connection to the RS-232 interface:

Balance	Cables
AND ER, FR, FX with RS-232 interface (OP-03)	6.2125.020 + 6.2125.010
Mettler AB, AG, PR (LC-RS9)	In the scope of delivery for the balance
Mettler AM, PM, PE with interface option 016 or Mettler AJ, PJ with interface option 018	6.2146.020 + 6.2125.010 Also from Mettler: ME 47473 adapter and either ME 42500 hand switch or ME 46278 foot switch
Mettler AT	6.2146.020 + 6.2125.010 Also from Mettler: ME 42500 hand switch or ME 46278 foot switch
Mettler AX, MX, UMX, PG, AB-S, PB-S, XP, XS	6.2134.120



Balance	Cables
Mettler AE with interface option 011 or 012	6.2125.020 + 6.2125.010 Also from Mettler: ME 42500 hand switch or ME 46278 foot switch
Ohaus Voyager, Explorer, Analytical Plus	Cable AS017-09 from Ohaus
Precisa balances with RS-232-C interface	6.2125.080 + 6.2125.010
Sartorius MP8, MC, LA, Genius, Cubis	6.2134.060
Shimadzu BX, BW	6.2125.080 + 6.2125.010

Operation with Touch Control

- 1 Plug in the USB plug of the USB/RS-232 adapter at the USB connector of the 907 Titrande.
- 2 Connect the RS-232 interface of the USB/RS-232 adapter with the RS-232 interface of the balance (see table for cable).
- 3 Switch on the Touch Control.
- 4 Switch on the balance.
- 5 Activate the RS-232 interface of the balance if necessary.
- 6 Configure the RS-232 interface of the USB/RS-232 adapter in the device manager of the Touch Control (see Touch Control manual).

4.4.5 Connecting a keyboard (only for operation with Touch Control)

The computer keyboard is used as an aid for text and numerical input.

- 1 Insert the USB plug of the keyboard into 1 of the USB port of the 907 Titrande.
- 2 Switch on the Touch Control.

The keyboard is recognized automatically and entered in the device manager.

- 3 Configure the keyboard in the device manager of the Touch Control (see Touch Control manual).

4.4.6 Connecting a barcode reader

The barcode reader is used as an aid for text and numerical input. You can connect a barcode reader with USB interface.

Operation with Touch Control

- 1 Insert the USB plug of the barcode reader into 1 of the USB ports of the 907 Titrande.
- 2 Switch on the Touch Control.
The barcode reader is recognized automatically and entered in the device manager.
- 3 Configure the barcode reader in the device manager of the Touch Control (see Touch Control manual).

Settings on the barcode reader:

- 1 Switch the barcode reader to programming mode.
- 2 Specify the desired layout for the keyboard (USA, Germany, France, Spain, German-speaking Switzerland).
This setting must match the setting in the device manager (see the Touch Control manual).
- 3 Make sure that the barcode reader is set in such a way that Ctrl characters (ASCII 00 to 31) can be sent.
- 4 Program the barcode reader in such a way that the ASCII character 02 (STX or Ctrl B) is sent as the first character. This first character is normally referred to as the "Preamble" or "Prefix Code".
- 5 Program the barcode reader in such a way that the ASCII character 04 (EOT or Ctrl D) is sent as the last character. This last character is normally referred to as the "Postamble", "Record Suffix" or "Postfix Code".
- 6 Exit the programming mode.

4.5 Setting up the titration vessel

4.5.1 General

During the titration, it is important that the solution is mixed well. The stirring rate should be high enough to form a small vortex. If the stirring rate is too high, then air bubbles will be aspirated. This results in incorrect measured values. If the stirring rate is too low, then the solution at the electrode will not be mixed correctly. In order for the measurement to be taken in a well-mixed solution after the addition of the titrant, the tip should be positioned where turbulence is high. Furthermore, the distance between the addition of the titrant and the electrode should be as large as possible. Therefore, take into account the stirring direction (counterclockwise or clockwise) when positioning the electrode and tip (see figure below).

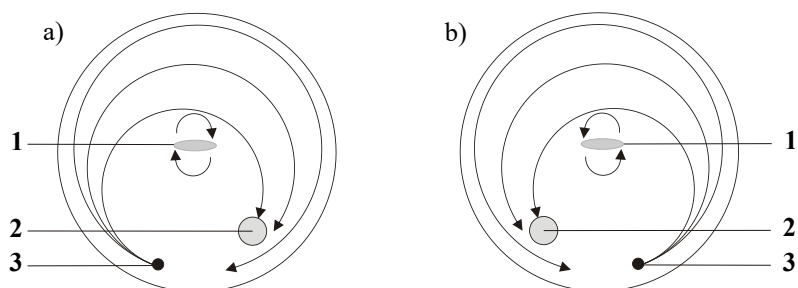

Figure 12 Diagrams showing magnetic stirrer, electrode, and tip during a titration. a) clockwise stirring direction, b) counterclockwise stirring direction.

1 Magnetic stirrer

2 Electrode

3 Tip

4.5.2 Titration vessel for volumetric KF titration

Mounting the KF titration cell

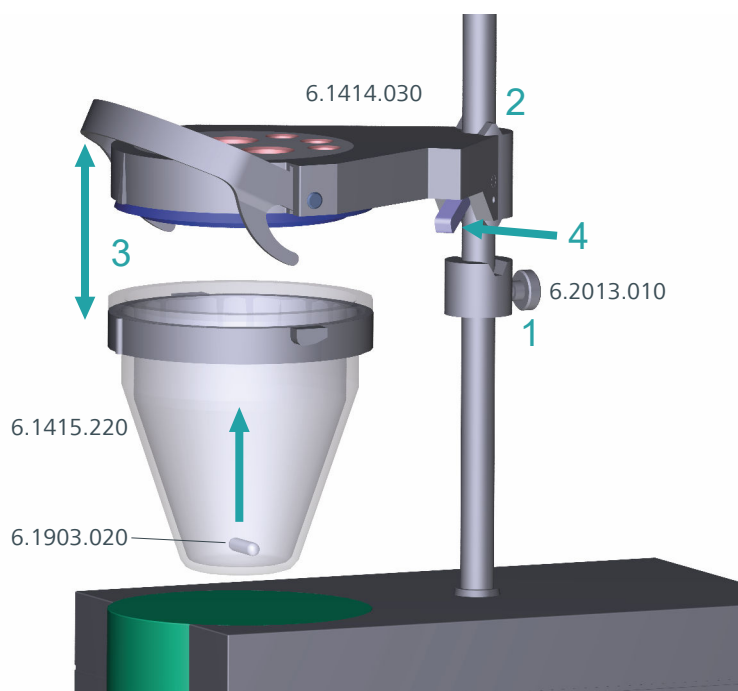

- 1** Screw the 6.2013.010 clamping ring tightly to the support rod.
- 2** Fix the 6.1414.030 vessel lid of the KF titration cell (with correctly inserted sealing ring from the 6.1244.040 sealing set) to the support rod. Keep the locking lever pressed down until it can be released at the desired position.
- 3** Fasten the 6.1415.220 (or 6.1415.250) titration vessel with a 6.1903.020 (or 6.1903.030) stirring bar inside on the vessel lid. Fold back the support bracket upwards while doing so. The markings on the vessel lid and on the plastic ring must be aligned above one another. Afterwards, press the support bracket downwards in order to fasten the titration vessel in place. The levers of the support bracket must enclose the pins of the plastic ring on the titration vessel in order to ensure a secure hold.

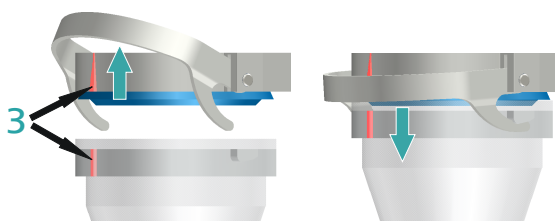

- 4** Adjust the height of the KF titration cell by pressing the locking lever. It should almost touch the surface of the stirrer. The position can now be fixed by readjusting the clamping ring.

If the height of the KF titration cell has been adjusted correctly, then the entire cell can now be raised and swiveled as required by pressing the locking lever.

Filling the adsorber tube

Before insertion, the 6.1403.040 adsorber tube must be filled with the 6.2811.000 / 6.2811.010 molecular sieve.

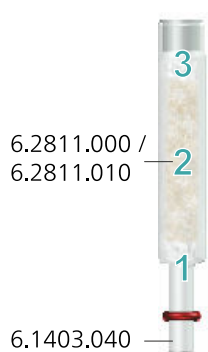

- 1** Insert a small cotton plug into the bottom of the adsorber tube. Do not pack the cotton too tightly.
- 2** Fill the molecular sieve up to $\frac{3}{4}$ of the height.
- 3** Place a small cotton plug on the molecular sieve. Do not pack the cotton too tightly.
- 4** Seal the adsorber tube with the associated lid.

Inserting the tips

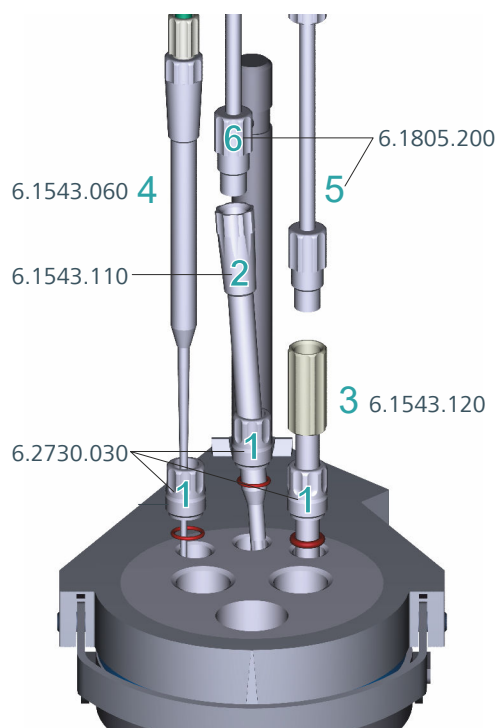

- 1** Place the 3 screw nipples from 6.2730.030 (including O-rings, but without stoppers) in the rear openings of the vessel lid.
- 2** Insert the 6.1543.110 dosing tip through the screw nipple in the middle rear opening.
- 3** Insert the 6.1543.120 aspiration tip through the screw nipple in the right rear opening.
If solvent is aspirated, then the end of the aspiration tip must touch the vessel base, but it must not inhibit the action of the stirring bar.
The aspiration tip can, if needed, be pulled out of the solvent.
- 4** Insert the 6.1543.060 tip through the screw nipple in the left rear opening.
- 5** Screw the 6.1805.200 PTFE M8 tubing of the aspiration bottle onto the aspiration tip.
- 6** Screw the 6.1805.200 PTFE M8 tubing of the solvent bottle onto the dosing tip.

4.6 Connecting sensors

The measuring interface contains the following measuring inputs:

- **Ind.** for a potentiometric electrode (pH, metal or ion-selective electrode)
- **Ref.** for a separate reference electrode
- **Temp.** for a temperature sensor (Pt1000 or NTC)
- **Pol.** for a polarizable electrode
- **iConnect** for an iConnect (measuring interface for electrodes with integrated memory chip, so-called iTrodes)

4.6.1 Connecting a pH, metal or ion-selective electrode

- 1 Plug the electrode plug into the **Ind.** socket of the 907 Titrand.

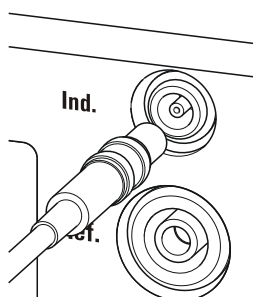

Figure 13 Connecting a pH, metal or ion-selective electrode



NOTE

The electrode cable is protected against accidental disconnection of the cable by means of a pull-out protection. If you wish to pull out the plug again, you first need to pull back the outer plug sleeve.

4.6.2 Connecting a reference electrode

- 1 Plug the electrode plug into the **Ref.** socket of the 907 Titrand.

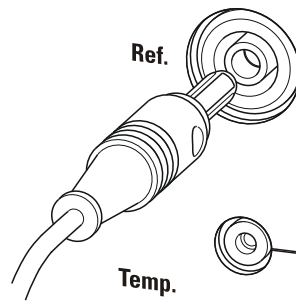

Figure 14 Connecting a reference electrode

4.6.3 Connecting a polarizable electrode

- 1 Plug the electrode plug into the **Pol.** socket of the 907 Titrande.

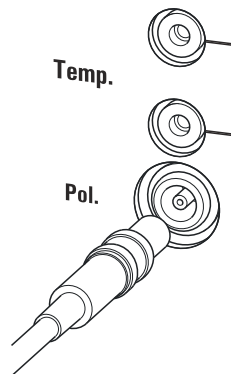

Figure 15 Connecting a polarizable electrode



NOTE

The electrode cable is protected against accidental disconnection of the cable by means of a pull-out protection. If you wish to pull out the plug again, you first need to pull back the outer plug sleeve.

4.6.4 Connecting a temperature sensor or an electrode with integrated temperature sensor

A temperature sensor of the Pt1000 or NTC type can be connected to the **Temp.** connector.

- 1 Plug the temperature sensor plug into the **Temp.** sockets of the Titrande.

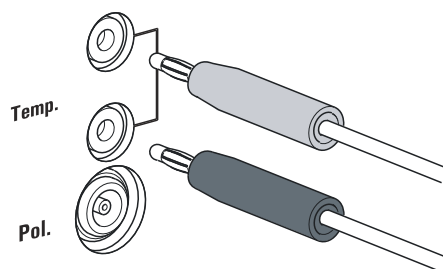

Figure 16 Connecting a temperature sensor or an electrode with integrated temperature sensor



NOTE

Always insert the red plug into the red socket. This is the only way that shielding against electrical interference can be ensured.

4.6.5 Connecting the iConnect

The external measuring interface 854 iConnect can be connected to the **iConnect** connector.

Connecting the 6.2168.000 mini USB adapter cable to an instrument

- 1 Plug the mini USB adapter cable (2) into the **iConnect** connector of the instrument (1). Observe the correct orientation (markings).

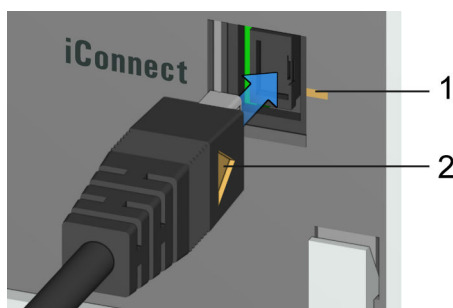

Figure 17 Plugging in the mini USB adapter cable

Depending on the instrument's model version, there may be several **iConnect** connectors.

- 2 Leave the adapter cable plugged in to protect the connector inside the instrument (1) against mechanical impact.

Connecting the 854 iConnect to the adapter cable

Check whether the mini USB adapter cable is connected to the instrument.

The 854 iConnect can also be connected while the instrument is switched on.

- 1 Plug the plug of the 854 iConnect (3) into the socket of the mini USB adapter cable (2). Observe the correct orientation (markings).

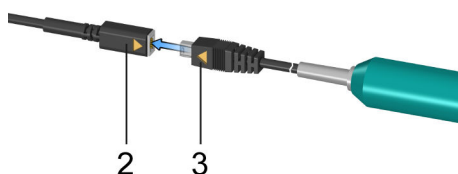

Figure 18 Plugging in the 854 iConnect

As soon as the instrument is switched on, the 854 iConnect is detected automatically and entered as measuring input into the device properties.

Connecting the electrode

The 854 iConnect is used as measuring input for iTrodes (electrodes with integrated memory chip).

- 1 Remove the protective cap of the 854 iConnect.

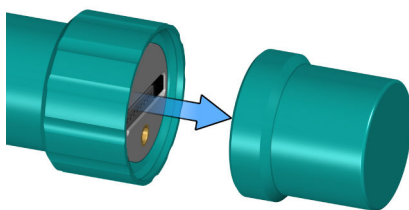

Figure 19 Removing the protective cap

- 2 Align the guide pin (5) of the electrode with the recess in the 854 iConnect (4).

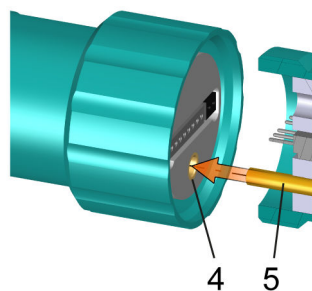

Figure 20 Aligning the guide pin

- 3 Attach the electrode to the 854 iConnect.

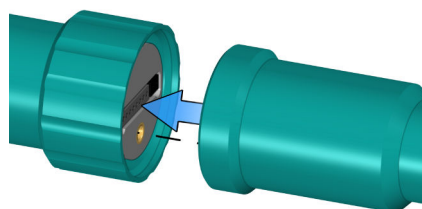

Figure 21 Attaching the electrode

The guide pin guarantees correct connection in such a way that the contact pins cannot be damaged.

- 4 Tighten the screw cap by hand.

If there is an electrode in the sensor list of the firmware or software, the electrode is detected automatically when connecting it.



NOTE

Mount the protective cap again as soon as the 854 iConnect is not in use anymore and no electrode is connected.

Removing the 854 iConnect

The 854 iConnect can also be removed while the instrument is switched on.

- 1 Unplug the 854 iConnect (3) from the socket of the mini USB adapter cable (2).

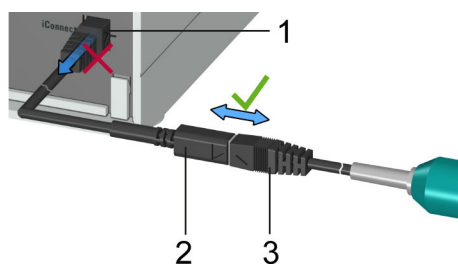

Figure 22 Unplugging the 854 iConnect

- 2 Leave the mini USB adapter cable (2) plugged into the socket of the instrument (1).



NOTE

Position the mini USB adapter cable in such a way that it cannot be removed inadvertently.



NOTE

For additional information on the 854 iConnect, see *Manual iConnect 854*, article number 8.854.8002.

4.6.6 Differential potentiometry

Potentiometric measurements with high-ohm measuring chains can be disrupted by electrostatic and electromagnetic fields in media with low conductivity. Use our 6.0229.100 Solvotrode or other special electrodes for pH measurements in organic solvents. If no reliable measurements are possible with these, then a 6.5104.030 (230 V) or 6.5104.040 (115 V) differential amplifier can be used. The differential amplifier is connected to the high-ohm measuring input (**Ind.**).

5 Karl Fischer titration

5.1 Volumetric titration

5.1.1 Principle of the volumetric Karl Fischer titration

The **volumetric Karl Fischer titration** is the classic method of water content determination. It works with a methanolic solution of iodine, sulfur dioxide, and a base as buffer substance. If an aqueous sample is titrated, then several reactions take place that can be summarized in the following sum equation:



According to the equation above, the I_2 reacts quantitatively with H_2O . This chemical equation serves as a basis for the water content determination.

The classic Karl Fischer method has constantly been developed during recent years. This development was not only about refining and automation of reagent dosing, but also improvements of endpoint indication and reagents. The disadvantage of this method is that the reagents are not completely stable. This means that the titer has to be re-determined regularly.

5.1.2 Endpoint determination

The titration endpoint is determined by an electrometric indication method. For this, double Pt wire electrodes or double Pt ring electrodes are used. A distinction is made between the two following indication methods:

Biamperometric indication (Upol)

A constant potential is applied to the electrodes and the resulting current is measured.

Bivoltametric indication (Ipol)

A direct or alternating current is applied between the 2 electrodes and the resulting potential is measured.

- 6** Pull the plunger of the syringe up to the end and shake the syringe back and forth somewhat.
The inside of the syringe is rinsed by water standard and freed of water contamination.
- 7** Dispose of the used water standard in a waste bottle.
- 8** Draw the rest of the water standard into the syringe, aspirating as little air as possible.
- 9** Push out any air bubbles that may be present in the syringe.
- 10** Wipe off the needle with a lint-free paper towel and cover it with the appropriate cap.
- 11** Place the syringe on the balance and press **[TARA]**.
- 12** As soon as the drift on the 907 Titrande is stable, take the syringe in your hand, press **[START]** and inject approx. 1 mL of the water standard through the septum.
There are two possibilities:
 - Version 1:
Inject the water standard without immersing the needle in the reagent liquid. If a little drop remains on the end of the needle, then it must be aspirated back before pulling the needle out of the septum.
The water standard should not be sprayed from the syringe onto the electrode nor onto the wall of the titration vessel.
 - Version 2:
Inject the water standard directly under the surface of the reagent liquid.
Take care to ensure that you do not aspirate any liquid at the time you withdraw the syringe from the reagent liquid.
- 13** Close the syringe with the same cap and place it back on the balance.
- 14** Read off the value displayed by the balance and enter it as sample size on the Touch Control or in the computer software (e.g. *tiamo*).



- 15** The next determination can be started as soon as the determination has been finished and the titration cell has been conditioned (drift stable) again.

5.1.6 Sample addition

This chapter contains a few notes concerning sample addition. Further notes can be found in the publications of the reagent manufacturers and in the Karl Fischer monograph published by Metrohm.

5.1.6.1 Size of the sample size

The sample weight should be small in order to be able to titrate as many samples as possible in the same electrolyte solution and thus to keep the titration time short. However, ensure that the sample contains at least 50 µg of H₂O. The following tables provide clues for the sample size.

Table 1 Approximate sample size in grams (5 mL cylinder volume)

Water content of the sample	KF reagent 1	KF reagent 2	KF reagent 5
0.5%	0.1–0.9	0.2–1.8	0.5–4.5
1.0%	0.05–0.45	0.1–0.9	0.25–2.25
5.0%		0.02–0.18	0.05–0.45
10.0%			0.03–0.22
25.0%			
50.0%			

Table 2 Approximate sample size in grams (10 mL cylinder volume)

Water content of the sample	KF reagent 1	KF reagent 2	KF reagent 5
0.5%	0.2–1.8	0.4–3.6	
1.0%	0.1–0.9	0.2–1.8	0.5–4.5
5.0%	0.02–0.18	0.04–0.36	0.1–0.9
10.0%		0.02–0.18	0.05–0.45
25.0%			0.02–0.18
50.0%			0.02–0.09

Table 3 Approximate sample size in grams (20 mL cylinder volume)

Water content of the sample	KF reagent 1	KF reagent 2	KF reagent 5
0.5%	0.4–3.6		
1.0%	0.2–1.8	0.4–3.6	
5.0%	0.04–0.36	0.08–0.72	0.2–1.8
10.0%	0.02–0.18	0.04–0.36	0.1–0.9
25.0%		0.02–0.14	0.04–0.36
50.0%			0.02–0.18

KF reagent 1: 1 mL KF reagent reacts with around 1 mg H₂O

KF reagent 2: 1 mL KF reagent reacts with around 2 mg H₂O

KF reagent 5: 1 mL KF reagent reacts with around 5 mg H₂O

5.1.6.2 Working with liquid samples

Liquid samples are added with a syringe. The samples can be injected two different ways:

- Use a syringe with a long needle that you immerse in the reagent during the injection.
- Use a syringe with a short needle and aspirate the last drop back into the needle.

The best way for you to determine the injected sample amount is to weigh the sample by difference.

Glass syringes should be used for the **determination of traces and validations**. We recommend obtaining these from a specialized syringe manufacturer.

Highly volatile samples and samples of low viscosity should be cooled before sampling. Doing so avoids losses while working. The syringe must, however, not be cooled directly, as condensation could be formed. For the same reason, no air may be aspirated into a syringe into which a cooled sample has been aspirated beforehand.

Samples of high viscosity can be thinned by heating. The syringe must be heated as well. The same target can be reached by diluting with a suitable solvent. In this case, the water content of the solvent has to be determined and subtracted as a blank value.

Viscous samples can be added to the measuring cell with a syringe without needle. You can use the ground-joint opening for this. The best way for you to determine the added sample amount is by weighing by difference the sample.

5.1.7.3 Indicator electrode

A new indicator electrode may require a certain warm-up time for surface formation. During this time, unexpectedly long titration times and excessively high measurement results can occur. This phenomenon will, however, disappear after a short time of use. In order to accelerate the setting of a new indicator electrode, the 907 Titrande can be conditioned (e.g. over night).

A contaminated indicator electrode can be carefully cleaned with an abrasive cleaner (6.2802.000 polishing set or toothpaste). After the cleaning, rinse with ethanol.

The two Pt wires of the indicator electrode should run as parallel as possible to one another. Check the Pt wires before inserting the electrode.

7 Troubleshooting

7.1 General

Problem	Cause	Remedy
The "On" LED is not illuminated, even though the instrument is connected to the power supply.	<i>The Touch Control or the computer has not been switched on yet or the plugs are not correctly plugged in.</i>	<ol style="list-style-type: none"> 1. Check the plug connections. 2. Switch on the Touch Control or the computer.

7.2 Karl Fischer titration

Problem	Cause	Remedy
The drift is very high during conditioning.	<i>The titration cell is leaking.</i>	<ul style="list-style-type: none"> ▪ Check the seals and the septum. Replace if necessary. ▪ Replace the molecular sieve.
The drift becomes greater after each titration.	<i>The sample releases water very slowly.</i>	<ul style="list-style-type: none"> ▪ Adjust the method. ▪ Add solubility promoter. ▪ Increase the temperature (possibly using a KF oven). ▪ See technical literature.
	<i>A side reaction is taking place.</i>	<ul style="list-style-type: none"> ▪ Use special reagents. ▪ Adjust the method (increase/decrease the temperature, external extraction). ▪ See technical literature.
	<i>The pH value is no longer in the optimum range.</i>	Add buffer (see technical literature).
The titration will not be finished.	<i>The titration cell is leaking.</i>	<ul style="list-style-type: none"> ▪ Check the seals and the septum. Replace if necessary. ▪ Replace the molecular sieve.
	<i>The minimum increment is too low.</i>	Select the user-defined titration rate and increase the minimum volume increment (see manual/help of the software used).
	<i>The stop criterion is unsuitable.</i>	Adjust the control parameters (see manual/help of the software used): <ul style="list-style-type: none"> ▪ Increase the stop drift.

7.3 SET titration

Problem	Cause	Remedy
The titration will not be finished.	<i>The minimum dosing rate is too low.</i>	Select the user-defined titration rate and increase the minimum rate (see manual/help of the software used).
	<i>The stop criterion is unsuitable.</i>	Adjust the control parameters (see manual/help of the software used): <ul style="list-style-type: none"> ▪ Increase the stop drift. ▪ Select a short delay time.
The sample is over-titrated.	<i>The control parameters are unsuitable.</i>	Adjust the control parameters (see manual/help of the software used): <ul style="list-style-type: none"> ▪ Select Titration rate = slow. ▪ Select the user-defined titration rate and increase the control range. ▪ Select the user-defined titration rate and reduce the maximum rate. ▪ Select the user-defined titration rate and reduce the minimum rate. ▪ Stir faster. ▪ Arrange the electrode and tip to an optimum.
	<i>The electrode responds too slowly.</i>	Replace the electrode.
The titration time is too long.	<i>The control parameters are unsuitable.</i>	Adjust the control parameters (see manual/help of the software used): <ul style="list-style-type: none"> ▪ Select Titration rate = optimal or fast. ▪ Select the user-defined titration rate and decrease the control range. ▪ Select the user-defined titration rate and increase the maximum rate. ▪ Select the user-defined titration rate and increase the minimum rate.
The results are spread widely.	<i>The minimum dosing rate is too high.</i>	Select user-defined titration rate and decrease the minimum rate (see manual/help of the software used).
	<i>The electrode responds too slowly.</i>	Replace the electrode.



8 Appendix

8.1 Remote interface

The 6.2148.010 Remote Box allows devices to be controlled which cannot be connected directly to the MSB interface of the Titrande.

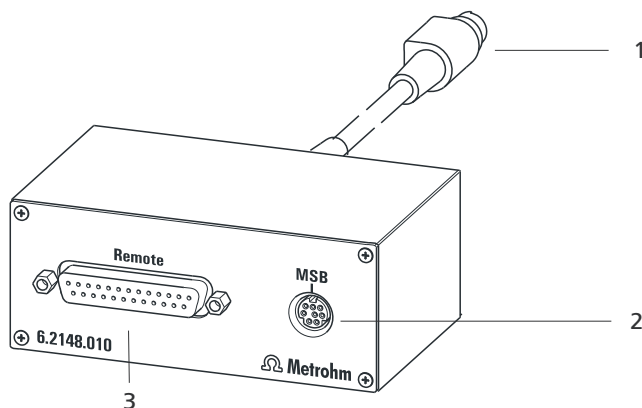

Figure 23 Connectors of the Remote Box

1 Cable

For connecting to the Titrande.

2 MSB connector

Metrohm Serial Bus. For connecting external dosing devices or stirrers.

3 Remote connector

For connecting instruments with a remote interface.

8.1.1 Pin assignment of the remote interface

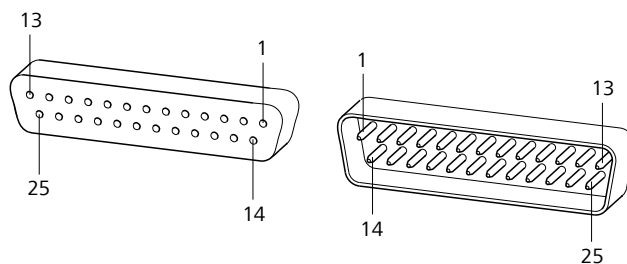
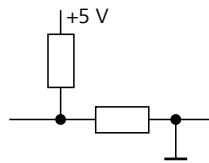

Figure 24 Pin assignment of remote socket and remote plug

The above figure of the pin assignment applies for all Metrohm instruments with 25-pin D-Sub remote connector.

Inputsapprox. 50 k Ω Pull-up

 $t_p > 20 \text{ ms}$

active = low, inactive = high

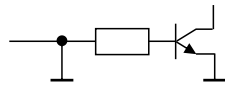
Outputs

Open Collector

 $t_p > 200 \text{ ms}$

active = low, inactive = high

 $I_C = 20 \text{ mA}$, $V_{CE0} = 40 \text{ V}$

+5 V: maximum load = 20 mA

The following tables offer information concerning the assignment of the individual pins and their function:

Table 4 Inputs and outputs of the remote interface

Assignment	Pin No.	Function*
Input 0	21	Start
Input 1	9	Stop
Input 2	22	
Input 3	10	Quit
Input 4	23	–
Input 5	11	
Input 6	24	
Input 7	12	
Output 0	5	Ready
Output 1	18	Conditioning OK
Output 2	4	Determination
Output 3	17	EOD
Output 4	3	
Output 5	16	Error
Output 6	1	
Output 7	2	Warning



Assignment	Pin No.	Function*
Output 8	6	
Output 9	7	
Output 10	8	
Output 11	13	
Output 12	19	
Output 13	20	
0 volts / GND	14	
+5 volts	15	
0 volts / GND	25	

* Signal activated only for operation with Touch Control.

Table 5 Explanation of the individual functions

Function	Explanation
Start	The current method is started at the time of activation. $t_{\text{pulse}} > 100 \text{ ms}$
Stop	The current method is canceled (Stop) at the time of activation. $t_{\text{pulse}} > 100 \text{ ms}$
Quit	The current command in the determination run will be canceled at the time of activation. $t_{\text{pulse}} > 100 \text{ ms}$
Ready	The instrument is ready to receive a start signal.
Conditioning OK	The line is set when Conditioning with SET titration and KFT titration is at OK. The line remains set until the determination is started with [START] .
Determination	The instrument performs a data-generating determination.
EOD	End of Determination. Pulse ($t_{\text{pulse}} = 200 \text{ ms}$) after a determination or after a buffer/standard solution during calibration using a Sample Processor.
Error	The line is set for error message display.

Function	Explanation
Warning	The line is set for warning message display.

9 Recycling and disposal

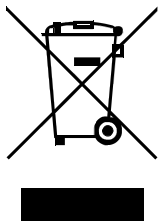

Properly dispose of chemicals and of the product to reduce negative effects on the environment and public health. Local authorities, waste disposal companies or dealers provide more detailed information on disposal. Observe the WEEE EU directive (WEEE = Waste Electrical and Electronic Equipment) for the proper disposal of waste electronic equipment within the European Union.

10 Technical specifications

10.1 Measuring interface

Depending on the version, the 907 Titrande has one (version 2.907.0010) or two (version 2.907.x020) galvanically isolated measuring interface(s).

The measuring cycle is 100 ms for all measuring modes.

10.1.1 Potentiometry

One high-ohm measuring input (**Ind.**) for pH, metal or ion-selective electrodes and one measuring input (**Ref.**) for separate reference electrodes.

<i>Input resistance</i>	> 1–10 ¹² Ω
<i>Offset current</i>	< 1 · 10 ⁻¹² A (under reference conditions)
<i>Measuring mode</i>	
<i>pH</i>	
<i>Measuring range</i>	-13 to +20 pH
<i>Resolution</i>	0.001 pH
<i>Measuring accuracy</i>	±0.003 pH (±1 digit, without sensor error, under reference conditions)
<i>Measuring mode</i>	
<i>U</i>	
<i>Measuring range</i>	-1,200 to +1,200 mV
<i>Resolution</i>	0.1 mV
<i>Measuring accuracy</i>	±0.2 mV (±1 digit, without sensor error, under reference conditions)

10.1.2 Temperature

A measuring input (**Temp.**) for temperature sensors of the Pt1000 or NTC type with automatic temperature compensation.

R (25 °C) and B value can be configured for NTC sensors.

<i>Measuring range</i>	
<i>Pt1000</i>	-150 to +250 °C
<i>NTC</i>	-5 to +250 °C (R (25 °C) = 30,000 Ω and B (25/50) = 4,100 K)

*Resolution*

Pt1000 0.1 °C

NTC 0.1 °C

Measuring accuracy

Pt1000 ±0.2 °C
(Applies for measuring range –20 to +150 °C; ±1 digit; without sensor error, under reference conditions)

NTC ±0.6 °C
(Applies for measuring range +10 to +40 °C; ±1 digit; without sensor error, under reference conditions)

10.1.3 Polarizer

One measuring input (**Pol.**) for polarizable electrodes.

*Measuring mode
I_{pol}*

Determination with adjustable polarization current

Polarization current –122.5 to +122.5 µA (increment: 0.5 µA)
–125.0 to +125.0 µA: non-guaranteed values, dependent on reference voltage +2.5 V

Measuring range –1,200 to +1,200 mV

Resolution 0.1 mV

Measuring accuracy ±0.2 mV
(±1 digit, without sensor error, under reference conditions)

*Measuring mode
U_{pol}*

Determination with adjustable polarization voltage

Polarization voltage –1,225 to +1,225 mV (increment: 25 mV)
–1,250 to +1,250 mV: non-guaranteed values, dependent on reference voltage +2.5 V

Measuring range –120 to +120 µA

Resolution 0.1 µA

10.2 Power connection

<i>Supply voltage</i>	100–240 V ($\pm 10\%$)
<i>Frequency</i>	50–60 Hz ($\pm 3\%$)
<i>Power consumption</i>	max. 45 W
<i>Fuse</i>	Electronic overload protection

10.3 Ambient conditions

<i>Automatic interior temperature monitoring</i>	
<i>Nominal function range</i>	+5 to +45 °C at max. 80% relative humidity, non-condensing
<i>Storage</i>	+5 to +45 °C at max. 80% relative humidity, non-condensing
<i>Altitude / Pressure range</i>	max. 2,000 m. above sea level / min. 780 mbar
<i>Overvoltage category</i>	II
<i>Pollution degree</i>	2

10.4 Reference conditions

<i>Ambient temperature</i>	+25 °C (± 3 °C)
<i>Relative humidity</i>	$\leq 60\%$
<i>Device status</i>	The device is in operation for at least 30 min.



10.5 Dimensions

<i>Width</i>	142 mm
<i>Height</i>	227 mm
<i>Depth</i>	231 mm
<i>Weight</i>	2.7 kg (without accessories)
<i>Material (housing)</i>	Polybutylene terephthalate (PBT)

10.6 Interfaces

USB connectors

<i>USB ports</i>	2 USB downstream ports (type A sockets), 500 mA, for connecting peripheral devices such as printers, keyboards, barcode readers or RS-232/USB boxes (6.2148.020).
------------------	---

"Controller" connector

<i>Controller port</i>	USB upstream port with auxiliary power supply (Mini DIN socket) for connecting Touch Control or computer for controlling the 907 Titrande.
<i>Touch Control</i>	With integrated Touch Control cable.
<i>Computer</i>	With 6.2151.000 cable

MSB connectors (Metrohm Serial Bus)

<i>Dosing device</i>	Connection of a max. of 4 external dosing devices of the Dosimat or Dosino (MSB 1 to MSB 4) types.
<i>Stirrer</i>	Connection of a max. of 4 stirrers. Stirrer control: Switching on/off manually or coordinated with the titration sequence. Speed in 15 steps and shift direction can be selected.
<i>Remote Box</i>	Connection of a max. of 4 Remote Boxes. Remote Boxes can be used to actuate and monitor external devices.

Index

- 6.2151.000 controller cable 15
 685 Dosimat plus 18
 700 Dosino 18
 800 Dosino 18
 801 Stirrer 19
 803 Ti Stand 19
 804 Ti Stand 19
 805 Dosimat 18
- A**
 ADD 4
 Ambient conditions 55
- B**
 Balance 23
 Barcode reader
 Connect 25
- C**
 Calibration mode
 CAL 4
 Computer
 Connect 15
 Computer keyboard
 Connect 24
 Connect
 Balance 23
 Barcode reader 25
 Computer 15
 Computer keyboard 24
 Dosing device 18
 MSB devices 17
 Power grid 14
 Printer 22
 Remote Box 20
 Stirrer 19
 Titration stand 19
 Touch Control 13
 USB hub 22
 Connector
 MSB 2
 USB 2
 Controller
 Connector 11
- D**
 DET 3
 Device description 2
 Device software
 Update 2
- Differential potentiometry 36
 Dosing command 3
 ADD 4
 EMPTY 4
 LQH 4
 PREP 4
 Dosing device
 Connect 18
 Driver software
 Install 15
- E**
 Electrode
 Connect 31
 Electrode test
 ELT 4
 Electrostatic charge 9
 EMPTY 4
- H**
 Humidity 55
- I**
 Indicator electrode
 Warm-up time 43
 Installation
 Driver software 15
 Instrument type 11
- K**
 Keyboard
 Connect 24
 KFT 4
- L**
 LED
 On 45
 LQH 4
- M**
 Maintenance 44
 MEAS 4
 Measuring interface 2, 11
 Measuring mode 3
 MEAS 4
 STDADD 4
 MET 3
 Metrohm Serial Bus MSB, see also
 "MSB" 17
- MSB
 Connect devices 17
 Connector 11
 MSB connector 2
- O**
 Operation 55
 Overview of the device 10
 Overvoltage category 55
- P**
 Pin assignment 48
 Power connection 11, 14
 PREP 4
 Printer 22
- R**
 Reagent replacement 42
 Remote
 Interface 48
 Pin assignment 48
 Remote Box
 Connect 20
- S**
 Safety instructions 7
 Sample
 Liquid 41
 Solid 42
 Sample size
 Size 40
 Sea level 55
 Sensor
 Connect 31
 Serial number 11
 Service 8
 SET 3
 STAT 3
 STDADD 4
 Stirrer
 Connect 19
 Stirring direction 26
 Storage 55
 Supply voltage 9
 System test 13
- T**
 Temperature 55
 Temperature sensor
 Connect 31

