

867 pH Module



Manual

8.867.8003EN / 2025-09-12



Metrohm AG
CH-9100 Herisau
Switzerland
Phone +41 71 353 85 85
Fax +41 71 353 89 01
info@metrohm.com
www.metrohm.com

867 pH Module

Manual

Technical Communication
Metrohm AG
CH-9100 Herisau
techcom@metrohm.com

This documentation is protected by copyright. All rights reserved.

This documentation has been prepared with great care. However, errors can never be entirely ruled out. Please send comments regarding possible errors to the address above.

Table of contents

1	Introduction	1
1.1	pH Module system	1
1.2	Instrument description	2
1.3	Measuring modes and commands	2
1.4	Accessories	3
1.5	Symbols and conventions	4
2	Safety	6
2.1	Intended use	6
2.2	Responsibility of the operator	6
2.3	Personnel requirement	7
2.4	Safety instructions	7
2.4.1	Electrical safety	7
2.4.2	Tubing and capillary connections	8
2.4.3	Flammable solvents and chemicals	8
3	Overview of the instrument	9
4	Installation	11
4.1	Setting up the instrument	11
4.1.1	Packaging	11
4.1.2	Checks	11
4.1.3	Location	11
4.2	Connecting a controller	11
4.2.1	Operation	11
4.3	Connecting MSB devices	16
4.3.1	Connecting a dosing device	17
4.3.2	Connecting a stirrer or titration stand	18
4.3.3	Connecting a Remote Box	19
4.4	Connecting USB devices	20
4.4.1	General	20
4.4.2	Connecting a USB hub	21
4.4.3	Connecting a printer	21
4.4.4	Connecting a balance	22
4.4.5	Connecting a PC keyboard (only for operation with Touch Control)	23
4.4.6	Connecting a barcode reader	24
4.5	Connecting sensors	25
4.5.1	Connecting a pH, metal or ion-selective electrode	25



4.5.2	Connecting a reference electrode	26
4.5.3	Connecting a polarizable electrode	26
4.5.4	Connecting a temperature sensor or an electrode with integrated temperature sensor	27
4.5.5	Connecting the iConnect	27
5	Operation and maintenance	31
5.1	General notes	31
5.1.1	Care	31
5.1.2	Maintenance by Metrohm Service	31
6	Troubleshooting	32
6.1	General	32
7	Appendix	34
7.1	Remote interface	34
7.1.1	Pin assignment of the remote interface	34
8	Technical specifications	38
8.1	Measuring interface	38
8.1.1	Potentiometry	38
8.1.2	Temperature	39
8.1.3	Polarizer	39
8.2	Power connection	40
8.3	Ambient conditions	40
8.4	Reference conditions	40
8.5	Dimensions	41
8.6	Interfaces	41
	Index	42

Table of figures

Figure 1	867 pH Module system	1
Figure 2	Front 867 pH Module	9
Figure 3	Rear 867 pH Module	10
Figure 4	Connecting the Touch Control	12
Figure 5	Connecting the computer	15
Figure 6	MSB connections	16
Figure 7	Connecting a dosing device	18
Figure 8	Connecting an MSB stirrer	19
Figure 9	Connecting the rod stirrer to the titration stand	19
Figure 10	Connecting the Remote Box	20
Figure 11	Connecting a printer	22
Figure 12	Connecting a pH, metal or ion-selective electrode	25
Figure 13	Connecting a reference electrode	26
Figure 14	Connecting a polarizable electrode	26
Figure 15	Connecting a temperature sensor or an electrode with integrated temperature sensor	27
Figure 16	Plugging in the mini USB adapter cable	28
Figure 17	Plugging in the 854 iConnect	28
Figure 18	Removing the protective cap	29
Figure 19	Aligning the guide pin	29
Figure 20	Attaching the electrode	29
Figure 21	Unplugging the 854 iConnect	30
Figure 22	Connectors of the Remote Box	34
Figure 23	Pin assignment of remote socket and remote plug	34

1 Introduction

1.1 pH Module system

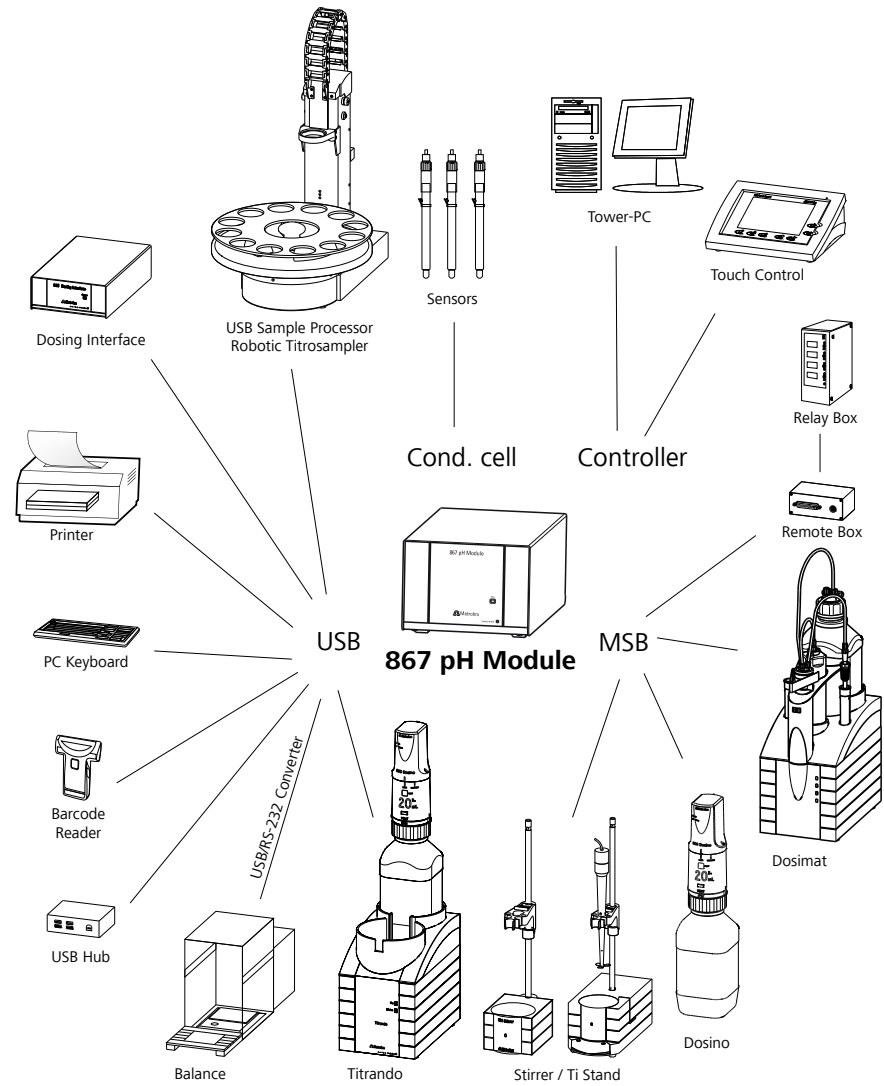

Figure 1 867 pH Module system

- **STDADD**

The measuring modes for standard addition are listed separately only in *tiamo*TM. In Touch Control they are integrated in the measuring mode MEAS Conc.

The following measuring modes can be selected for measurements:

- **auto** (automatic addition of the standard addition solution by specifying a potential difference)
- **dos** (automatic addition of the standard addition solution by specifying the single volume increments)
- **man** (manual addition of the standard addition solution)

- **CAL**

Electrode calibration.

Measuring mode:

- **pH** (calibration of pH electrodes)
- **Conc** (calibration of ion-selective electrodes)

- **ELT**

Electrode test for pH electrodes.

This mode is listed separately only in *tiamo*TM. In Touch Control, the electrode test is a component part of the CAL calibration mode.

- **Dosing commands**

The following commands for dosing can be selected:

- **PREP** (rinsing the cylinder and tubings of an exchange unit or dosing unit)
- **EMPTY** (emptying the cylinder and tubings of a dosing unit)
- **ADD** (dosing a specified volume)
- **LQH** (carrying out complex dosing tasks with a Dosino)

1.4 Accessories

Up-to-date information on the scope of delivery and optional accessories for your product can be found on the Internet. You can download this information using the article number as follows:

Downloading the accessories list

1 Enter <https://www.metrohm.com/> into your Internet browser.

2 Enter the article number (e.g. **867**) into the search field.

The search result is displayed.

3 Click on the product.

Detailed information regarding the product is shown on various tabs.

- 4** On the **Included parts** tab, click on **Download the PDF**.

The PDF file with the accessories data is created.







NOTE

Once you have received your new product, we recommend downloading the accessories list from the Internet, printing it out and keeping it together with the manual for reference purposes.

1.5 Symbols and conventions

The following symbols and formatting may appear in this documentation:

(5-12)	Cross-reference to figure legend The first number refers to the figure number, the second to the device part in the figure.
1	Instruction step Perform the steps one after the other.
Method	Dialog text, parameter in the software
File ► New	Menu or menu item
[Continue]	Button or key
	WARNING This symbol draws attention to a possible life-threatening hazard or risk of injury.
	WARNING This symbol draws attention to a possible hazard due to electrical current.
	WARNING This symbol draws attention to a possible hazard due to heat or hot instrument parts.
	WARNING This symbol draws attention to a possible biological hazard.
	WARNING Warning of optical radiation



CAUTION

This symbol draws attention to possible damage to devices or device parts.



NOTICE

This symbol highlights additional information and tips.

2.3 Personnel requirement

Only qualified personnel may operate the product. Qualified personnel are persons who meet the following requirements:

- Knowledge of basic regulations on occupational safety and accident prevention.
- Knowledge regarding the application of fire prevention measures for laboratories.
- In-depth knowledge of handling hazardous chemicals.
- Personnel have been instructed and are able to operate the product safely and independently recognize and avoid potential dangers.
- The user documentation has been read and understood. The personnel operate the product according to the instructions in the user documentation.

2.4 Safety instructions

2.4.1 Electrical safety

The electrical safety when working with the instrument is ensured as part of the international standard IEC 61010.



WARNING

Only personnel qualified by Metrohm are authorized to carry out service work on electronic components.



WARNING

Never open the housing of the instrument. The instrument could be damaged by this. There is also a risk of serious injury if live components are touched.

There are no parts inside the housing which can be serviced or replaced by the user.

Supply voltage



WARNING

An incorrect supply voltage can damage the instrument.

Only operate this instrument with a supply voltage specified for it (see rear panel of the instrument).

Protection against electrostatic charges



WARNING

Electronic components are sensitive to electrostatic charges and can be destroyed by discharges.

Do not fail to pull the power cord out of the power socket before you set up or disconnect electrical plug connections at the rear of the instrument.

2.4.2 Tubing and capillary connections



CAUTION

Leaks in tubing and capillary connections are a safety risk. Tighten all connections well by hand. Avoid applying excessive force to tubing connections. Damaged tubing ends lead to leakage. Appropriate tools can be used to loosen connections.

Check the connections regularly for leakage. If the instrument is used mainly in unattended operation, then weekly inspections are mandatory.

2.4.3 Flammable solvents and chemicals



WARNING

All relevant safety measures are to be observed when working with flammable solvents and chemicals.

- Set up the instrument in a well-ventilated location (e.g. fume cupboard).
- Keep all sources of flame far from the workplace.
- Clean up spilled liquids and solids immediately.
- Follow the safety instructions of the chemical manufacturer.

3 Overview of the instrument

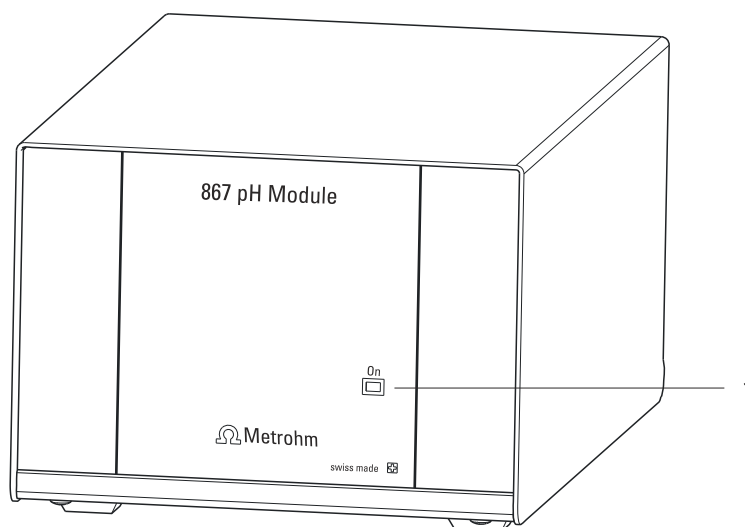

Figure 2 Front 867 pH Module

- 1 "On" LED**
Lights up when the pH Module is ready for operation.

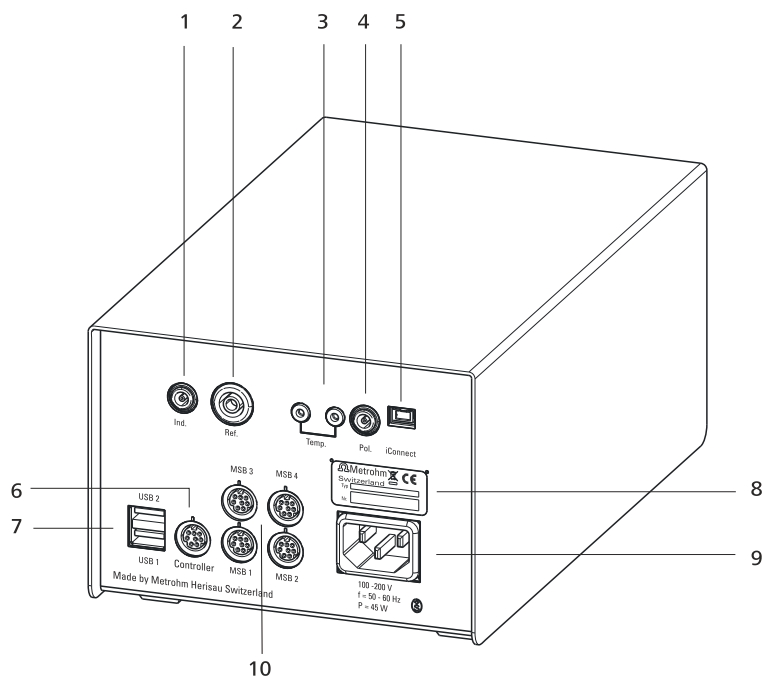

Figure 3 Rear 867 pH Module

<p>1 Electrode connector (Ind.) For connecting pH, metal or ion-selective electrodes with integrated or separate reference electrode. Socket F.</p>	<p>2 Electrode connector (Ref.) For connecting reference electrodes, e.g. Ag/AgCl reference electrode. Socket B, 4 mm.</p>
<p>3 Temperature sensor connector (Temp.) For connecting temperature sensors (Pt1000 or NTC). Two B sockets, 2 mm.</p>	<p>4 Electrode connector (Pol.) For connecting polarizable electrodes, e.g. double Pt wire electrodes. Socket F.</p>
<p>5 Electrode connector (iConnect) For connecting electrodes with integrated data chip (iTrodes).</p>	<p>6 Connector (Controller) For connecting a Touch Control or a PC with installed PC software. Mini DIN, 9-pin.</p>
<p>7 USB connector (USB 1 and USB 2) USB ports (type A) for connecting printer, keyboard, barcode reader, USB Sample Processor, etc.</p>	<p>8 Type plate Contains specifications concerning supply voltage, instrument type and serial number.</p>
<p>9 Power socket</p>	<p>10 MSB connector (MSB 1 to MSB 4) Metrohm Serial Bus. For connecting external dosing devices, stirrers or Remote Boxes. Mini DIN, 9-pin.</p>

4 Installation

4.1 Setting up the instrument

4.1.1 Packaging

The instrument is supplied in protective packaging together with the separately packed accessories. Keep this packaging, as only this ensures safe transportation of the instrument.

4.1.2 Checks

Immediately after receipt, check whether the shipment has arrived complete and without damage by comparing it with the delivery note.

4.1.3 Location

The instrument has been developed for operation indoors and may not be used in explosive environments.

Place the instrument in a location of the laboratory which is suitable for operation and free of vibrations and which provides protection against corrosive atmosphere and contamination by chemicals.

The instrument should be protected against excessive temperature fluctuations and direct sunlight.

4.2 Connecting a controller

4.2.1 Operation

Two different versions are available for operating the 867 pH Module:

- A Touch Control with touch-sensitive screen. It forms a "stand-alone instrument" together with the 867 pH Module.
- A computer enables operation of the 867 pH Module with the help of a PC software, e.g. *tiamo*.



CAUTION

Take care to ensure that the power cord is pulled out of the power socket before either setting up or disconnecting connections between the instruments.

4.2.1.1 Connecting a Touch Control



NOTE

The plug is protected against accidental disconnection of the cable by means of a pull-out protection feature. If you wish to pull out the plug, you first need to pull back the outer plug sleeve marked with arrows.

Connect the Touch Control as follows:

- 1 ■ Insert the plug of the Touch Control connection cable into the **Controller** socket.

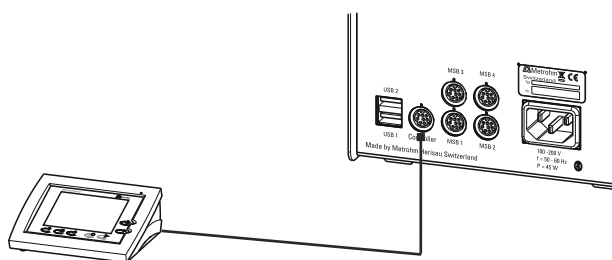

Figure 4 Connecting the Touch Control

- 2 ■ Connect the MSB devices (*see chapter 4.3, page 16*).
 - Connect the USB devices (*see chapter 4.4, page 20*).
- 3 ■ Connect the pH Module to the power grid (*see chapter 4.2.1, page 11*).
- 4 ■ Switch on the Touch Control.

The Touch Control power supply is supplied through the pH Module. Automatic system tests are performed on both instruments at the time of activation. The **On** LED on the front of the pH Module lights up when the system test has been completed and the instrument is ready for operation.



CAUTION

The Touch Control must be shut down properly by deactivation with the power switch on the rear of the instrument before the power supply is interrupted. If this is not done, then there is a danger of data loss. Because of the fact that the power supply for the Touch Control is provided through the pH Module, you must never disconnect the pH Module from the power grid (e.g. by deactivating with a connector strip) before you have deactivated the Touch Control.

If you would prefer not to position the Touch Control directly next to the pH Module, then you can lengthen the connection with the 6.2151.010 cable. The maximum connection length permitted is 5 m.

4.2.1.2 Connecting the instrument to the power grid



WARNING

Electric shock from electrical potential

Risk of injury by touching live components or through moisture on live parts.

- Never open the housing of the instrument while the power cord is still connected.
- Protect live parts (e.g. power supply unit, power cord, connection sockets) against moisture.
- Unplug the power plug immediately if you suspect that moisture has gotten inside the instrument.
- Only personnel who have been issued Metrohm qualifications may perform service and repair work on electrical and electronic parts.

Connecting the power cord

Accessories

Power cord with the following specifications:

- Length: max. 2 m
- Number of cores: 3, with protective conductor
- Instrument plug: IEC 60320 type C13
- Conductor cross-section 3x min. 0.75 mm² / 18 AWG
- Power plug:
 - according to customer requirement (6.2122.XX0)
 - min. 10 A

**NOTE**

Do not use a not permitted power cord!

1 Plugging in the power cord

- Plug the power cord into the instrument's power socket.
- Connect the power cord to the power grid.

4.2.1.3 Connecting a computer

The 867 pH Module requires a USB connection to a computer in order to be able to be controlled by a computer software. Using a 6.2151.000 controller cable, the instrument can be connected directly, either to a USB socket on a computer, to a connected USB hub or to a different Metrohm control instrument.

You need administrator rights for the installation of driver software and control software on your computer.

Cable connection and driver installation

A driver installation is required in order to ensure that the 867 pH Module is recognized by the computer software. To accomplish this, you must comply with the procedures specified. The following steps are necessary:

1 Install the software

- Insert the computer software installation CD and carry out the installation program directions.
- Exit the program if you have started it after the installation.

2 Establishing the cable connections

- Connect all peripheral devices to the instrument, *see chapter 4.3, page 16*.
- Connect the instrument to the power grid if you have not already done this (*see chapter 4.2.1.2, page 13*).
The "On" LED on the 867 pH Module is not yet illuminated!
- Connect the instrument to a USB connector (type A) of your computer (see manual of your computer). The 6.2151.000 cable is used for this purpose.

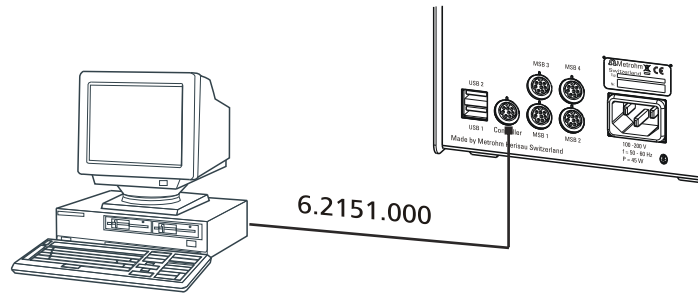

Figure 5 Connecting the computer

The instrument is recognized. Depending on the version of the Windows operating system used, the driver installation proceeds differently afterwards. Either the necessary driver software is installed automatically or an installation wizard is started.

3 Follow the instructions of the installation wizard.

The "On" LED on the 867 pH Module lights up when the driver installation has been completed and the instrument is ready for operation.

If problems should occur during installation, contact your company's IT support team.



NOTE

The plug on the instrument end of the 6.2151.000 controller cable is protected against accidental disconnection by means of a pull-out protection feature. If you wish to pull out the plug, you first need to pull back the outer plug sleeve marked with arrows.

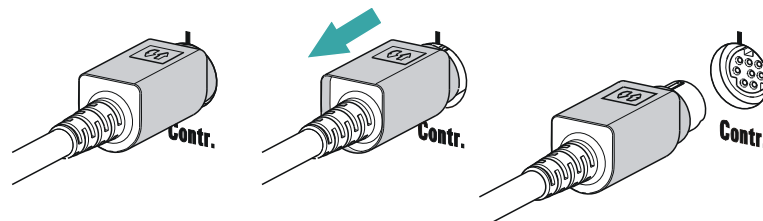

Registering and configuring the instrument in the computer software

The instrument must be registered in the configuration of your computer software. Once that has been done, you can then configure it according to your requirements. Proceed as follows:

1 Setting up the instrument

- Start the computer software.
The instrument is automatically recognized. The configuration dialog for the instrument is displayed.
- Make configuration settings for the instrument and its connectors.

More detailed information concerning the configuration of the instrument can be found in the documentation for the respective computer software.

4.3 Connecting MSB devices

In order to connect MSB devices, e.g. stirrers or dosing devices, Metrohm instruments are equipped with up to a maximum of four connectors on what is referred to as the *Metrohm Serial Bus* (MSB). Various kinds of peripheral devices can be connected in sequence (in series, as a "Daisy Chain") at a single MSB connector (8-pin Mini DIN socket) and controlled simultaneously by the respective control instrument. In addition to the connection cable, stirrers and the Remote Box are each equipped with their own MSB socket for this purpose.

The following figure provides an overview of the instruments that can be connected to an MSB socket, along with a number of different cabling variations.

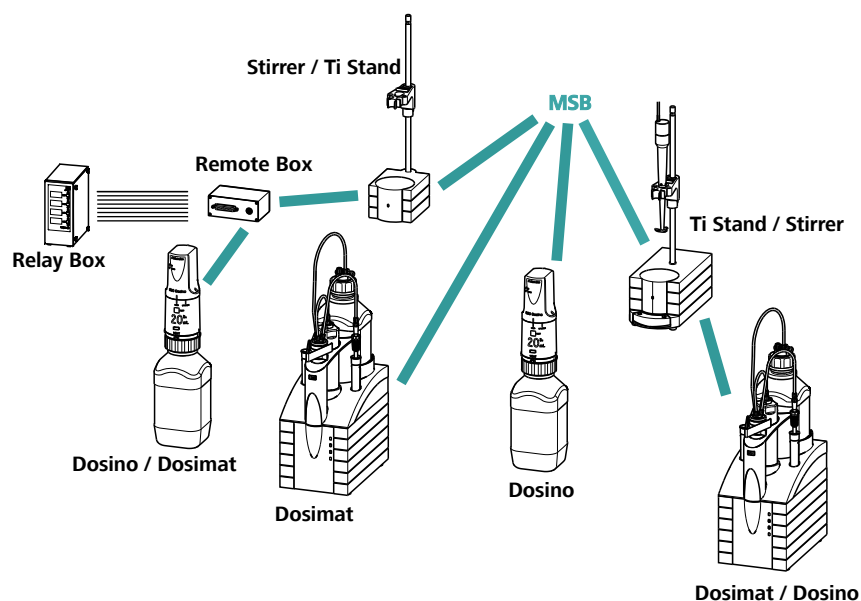

Figure 6 MSB connections

The control instrument determines which peripheral devices are supported.

**NOTE**

When connecting MSB devices together, the following must be observed:

- Only one device of the same type can be used at a single MSB connector at one time.
- Dosing devices of the 700 Dosino and 685 Dosimat plus type cannot be connected together with other MSB devices on a shared connector. These dosing devices must be connected separately.

**CAUTION**

Exit the control software before you plug in MSB devices. When it is switched on, the control instrument automatically recognizes which device is connected to which MSB connector. The operating unit or the control software enters the connected MSB devices into the system configuration (device manager).

MSB connections can be extended with the 6.2151.010 cable. The maximum connection length permitted is 15 m.

4.3.1 Connecting a dosing device

Four dosing devices can be connected to the instrument (**MSB 1 to MSB 4**).

The types of dosing devices that are supported are:

- 800 Dosino
- 700 Dosino
- 805 Dosimat
- 685 Dosimat plus

Proceed as follows:

1 Connecting a dosing device

- Exit the control software.
- Connect the connection cable of the dosing device to one of the sockets marked with **MSB** on the rear of the control device.
- Start the control software.

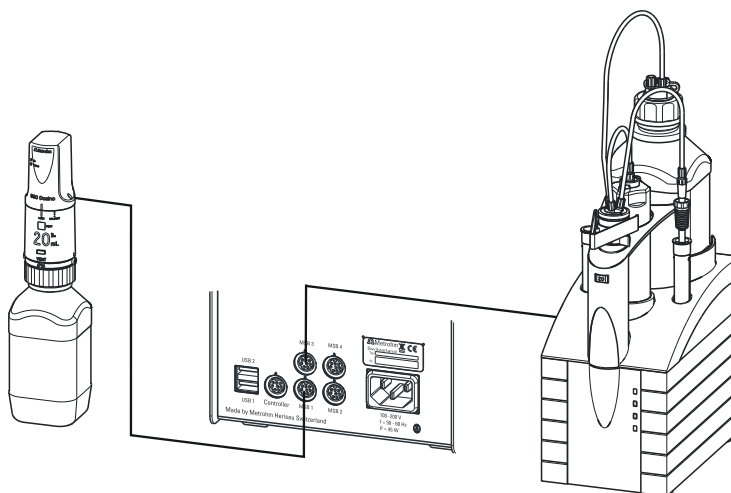

Figure 7 Connecting a dosing device

4.3.2 Connecting a stirrer or titration stand

You can use the following instruments:

These devices have a built-in magnetic stirrer (stirring "from below"):

- 801 Stirrer
- 803 Ti Stand

This device has no built-in magnetic stirrer (stirring "from above"):

- 804 Ti Stand with rod stirrer 802 Stirrer

Connect a stirrer or a titration stand as follows:

1 Connecting the stirrer or titration stand

- Exit the control software.
- Connect the connection cable of the magnetic stirrer or of the titration stand to one of the sockets marked with **MSB** on the rear of the control instrument.
- 804 Ti Stand only: Connect the rod stirrer to the stirrer connector (socket with stirrer symbol) of the titration stand.
- Start the control software.

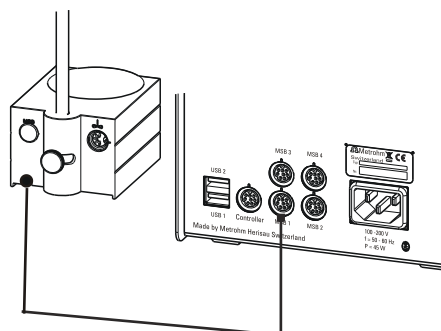

Figure 8 Connecting an MSB stirrer

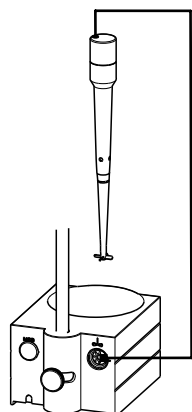

Figure 9 Connecting the rod stirrer to the titration stand

4.3.3 Connecting a Remote Box

Instruments that are controlled via remote lines and/or that send control signals via remote lines can be connected via the 6.2148.010 Remote Box. In addition to Metrohm, other instrument manufacturers also use similar connectors that make it possible to connect different instruments together. These interfaces are also frequently given the designations "TTL Logic", "I/O Control" or "Relay Control" and they generally have a signal level of 5 volts.

Control signals are understood to be electrical line statuses or electrical pulses (> 200 ms) which display the operating status of an instrument or which trigger or report an event. Sequences on a variety of instruments can thus be coordinated in a single complex automation system. However, no exchange of data is possible.

Proceed as follows:

1 Connecting the Remote Box

- Exit the control software.
- Connect the Remote Box connection cable to one of the sockets marked with **MSB** on the rear of the control instrument.
- Start the control software.

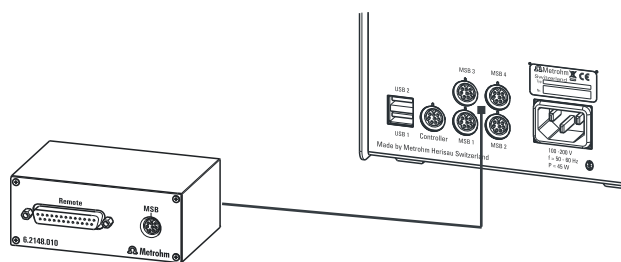

Figure 10 Connecting the Remote Box

You can connect the following instruments to the remote connector, among others:

- 849 Level Control (fill level monitoring in a canister)
- 731 Relay Box (switch box for 230/110 volt alternating current sockets and low-voltage direct current outlets)
- 843 Pump Station (for complex sample preparations or for rinsing external titration vessels)

The Remote Box also has an MSB socket at which a further MSB device, e.g. a dosing device or a stirrer, can be connected.

You will find precise information concerning the pin assignment of the interface on the Remote Box in the *appendix*.

4.4 Connecting USB devices

4.4.1 General

The 867 pH Module has two USB connectors (type A sockets) for peripheral devices with USB interfaces. The 867 pH Module functions as a USB hub (distributor) no matter how it is operated. If you wish to connect more than two devices to the USB, you can also use an additional, commercially available USB hub.



CAUTION

If you operate the 867 pH Module with the aid of the Touch Control, take care to ensure that the Touch Control is switched off when you set up or disconnect connections between the various instruments. If you use a PC software to control the 867 pH Module, you should exit the program before you set up or disconnect the USB connections.

4.4.2 Connecting a USB hub

If you wish to connect more than two devices to the USB connector of the 867 pH Module, you can also use an additional commercially available USB hub (distributor). If you operate the 867 pH Module with the help of the Touch Control, then you should use a USB hub with its own power supply.

Connect the USB hub as follows:

- 1** Switch off the Touch Control and/or exit the PC software.
- 2** With the aid of the 6.2151.020 cable, connect the USB connector of the 867 pH Module (type A) with the USB connector of the hub (type B, see manual for the hub).
- 3** Switch on the Touch Control.

The USB hub is recognized automatically.

4.4.3 Connecting a printer

Printers that are connected to the 867 pH Module with Touch Control must meet the following requirements:

- Printer languages: HP-PCL (PCL 3 to 5, PCL 3GUI), Canon BJL Commands or Epson ESC P/2
- Printer resolution: 300 dots/inch or 360 dots/inch (Epson)
- Paper size: A4 or Letter, single-sheet feed.

Connect the printer as follows:

- 1** Switch off the Touch Control.
- 2** With the aid of the 6.2151.020 cable, connect the USB connector of the 867 pH Module (type A) with the USB connector of the printer (type B, see manual for the printer).
- 3** Switch on the printer first, then the Touch Control.
- 4** Configure the printer in the device manager of the Touch Control (see Touch Control manual).

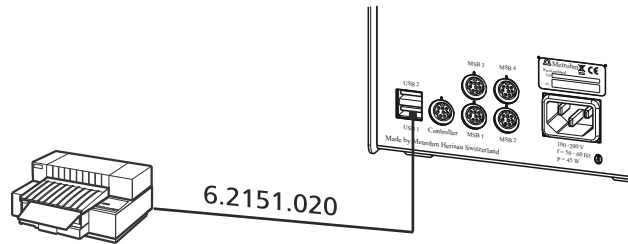

Figure 11 Connecting a printer

4.4.4 Connecting a balance

- Operation with a PC software:
 - Connect the balance directly to the serial connector (COM) of the computer. This is usually 9-pin and marked with the symbol **IOIOI**.
- Operation with Touch Control:
 - You will need the 6.2148.050 USB/RS-232 adapter to connect a balance.

The following table offers an overview of the balances that you can use together with the 867 pH Module and of which cable you will need for connection to the RS-232 interface:

Balance	Cable
AND ER, FR, FX with RS-232 interface (OP-03)	6.2125.020 + 6.2125.010
Mettler AB, AG, PR (LC-RS9)	In the scope of delivery for the balance
Mettler AM, PM, PE with interface option 016 or Mettler AJ, PJ with interface option 018	6.2146.020 + 6.2125.010 Also from Mettler: ME 47473 adapter and either ME 42500 hand switch or ME 46278 foot switch
Mettler AT	6.2146.020 + 6.2125.010 Also from Mettler: ME 42500 hand switch or ME 46278 foot switch
Mettler AX, MX, UMX, PG, AB-S, PB-S, XP, XS	6.2134.120
Mettler AE with interface option 011 or 012	6.2125.020 + 6.2125.010 Also from Mettler: ME 42500 hand switch or ME 46278 foot switch

Balance	Cable
Ohaus Voyager, Explorer, Analytical Plus	Cable AS017-09 from Ohaus
Precisa balances with RS-232-C interface	6.2125.080 + 6.2125.010
Sartorius MP8, MC, LA, Genius, Cubis	6.2134.060
Shimadzu BX, BW	6.2125.080 + 6.2125.010

Operation with Touch Control

Connect the balance as follows:

- 1 Plug in the USB plug of the USB/RS-232 adapter at the USB connector of the 867 pH Module.
- 2 Connect the RS-232 interface of the USB/RS-232 adapter with the RS-232 interface of the balance (see table for cable).
- 3 Switch on the Touch Control.
- 4 Switch on the balance.
- 5 Activate the RS-232 interface of the balance if necessary.
- 6 Configure the RS-232 interface of the USB/RS-232 adapter in the device manager of the Touch Control (see Touch Control manual).

4.4.5 Connecting a PC keyboard (only for operation with Touch Control)

The PC keyboard is used as an aid for text and numerical input.

Connect the PC keyboard as follows:

- 1 Insert the USB plug of the keyboard into one of the USB sockets of the 867 pH Module.
- 2 Switch on the Touch Control.

The keyboard is recognized automatically and entered in the device manager.



- 3 Configure the keyboard in the device manager of the Touch Control (see Touch Control manual).

4.4.6 Connecting a barcode reader

The barcode reader is used as an aid for text and numerical input. You can connect a barcode reader with USB interface.

Operation with Touch Control

Connect the barcode reader as follows:

- 1 Insert the USB plug of the barcode reader into one of the USB sockets of the 867 pH Module.
- 2 Switch on the Touch Control.
The barcode reader is recognized automatically and entered in the device manager.
- 3 Configure the barcode reader in the device manager of the Touch Control (see Touch Control manual).

Settings on the barcode reader:

Program the barcode reader as follows (see also the manual for the barcode reader):

- 1 Switch the barcode reader to programming mode.
- 2 Specify the desired layout for the keyboard (USA, Germany, France, Spain, German-speaking Switzerland).
This setting must match the setting in the device manager (see the Touch Control manual).
- 3 Make sure that the barcode reader is set in such a way that Ctrl characters (ASCII 00 to 31) can be sent.
- 4 Program the barcode reader in such a way that the ASCII character 02 (STX or Ctrl B) is sent as the first character. This first character is normally referred to as the "Preamble" or "Prefix Code".
- 5 Program the barcode reader in such a way that the ASCII character 04 (EOT or Ctrl D) is sent as the last character. This last character is

normally referred to as the "Postamble", "Record Suffix" or "Postfix Code".

- 6 Exit the programming mode.

4.5 Connecting sensors

The measuring interface contains the following measuring inputs:

- **Ind.** for a potentiometric electrode (pH, metal or ion-selective electrode)
- **Ref.** for a separate reference electrode
- **Temp.** for a temperature sensor (Pt1000 or NTC)
- **Pol.** for a polarizable electrode
- **iConnect** for an iConnect (measuring interface for electrodes with integrated data chip, so-called iTrodes)

4.5.1 Connecting a pH, metal or ion-selective electrode

Connect the pH, metal or ion-selective electrode as follows:

- 1 Plug the electrode plug into the **Ind.** socket of the 867 pH Module.

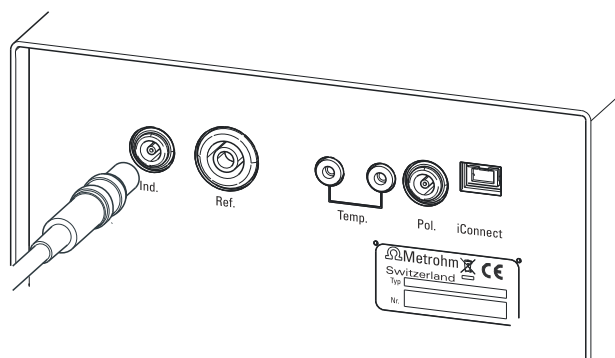

Figure 12 Connecting a pH, metal or ion-selective electrode



NOTE

The electrode cable is protected against accidental disconnection of the cable by means of a pull-out protection. If you wish to pull out the plug again, you first need to pull back the outer plug sleeve.



4.5.2 Connecting a reference electrode

Connect the reference electrode as follows:

- 1 Plug the electrode plug into the **Ref.** socket of the 867 pH Module.

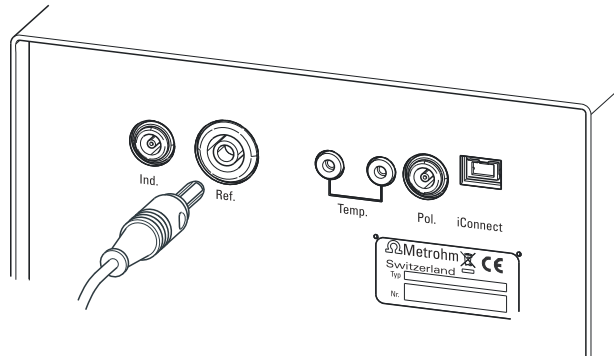

Figure 13 Connecting a reference electrode

4.5.3 Connecting a polarizable electrode

Connect the polarizable electrode as follows:

- 1 Plug the electrode plug into the **Pol.** socket of the 867 pH Module.

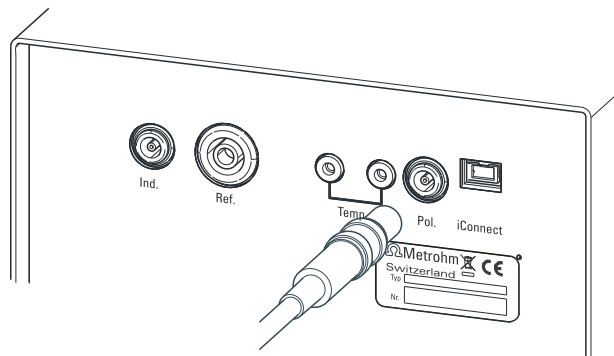

Figure 14 Connecting a polarizable electrode



NOTE

The electrode cable is protected against accidental disconnection of the cable by means of a pull-out protection. If you wish to pull out the plug again, you first need to pull back the outer plug sleeve.

4.5.4 Connecting a temperature sensor or an electrode with integrated temperature sensor

A temperature sensor of the Pt1000 or NTC type can be connected to the **Temp.** connector.

Connect the temperature sensor or the electrode with integrated temperature sensor as follows:

- 1 Insert the plugs of the temperature sensor into the **Temp.** sockets of the pH Module.

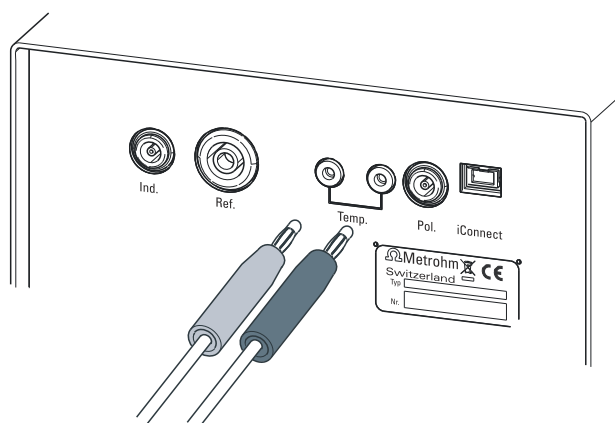

Figure 15 Connecting a temperature sensor or an electrode with integrated temperature sensor



NOTE

Always insert the red plug into the red socket. This is the only way that shielding against electrical interference can be ensured.

4.5.5 Connecting the iConnect

The external measuring interface 854 iConnect can be connected to the **iConnect** connector.

Connecting the 6.2168.000 mini USB adapter cable to an instrument

If the mini USB adapter cable is not connected to the instrument yet, proceed as follows:

- 1 Plug the mini USB adapter cable (2) into the **iConnect** connector of the instrument (1). Observe the correct orientation (markings).

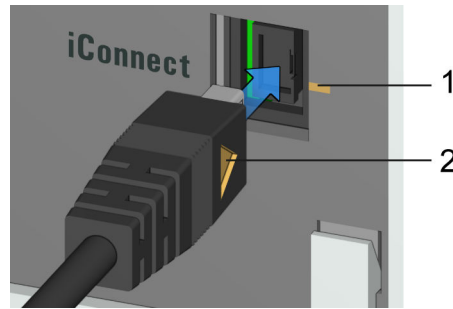

Figure 16 Plugging in the mini USB adapter cable

Depending on the instrument's model version, there may be several **iConnect** connectors.

- 2 Leave the adapter cable plugged in to protect the connector inside the instrument (1) against mechanical impact.

Connecting the 854 iConnect to the adapter cable

Make sure that the mini USB adapter cable is connected to the instrument.

The 854 iConnect can also be connected while the instrument is switched on.

- 1 Plug the plug of the 854 iConnect (3) into the socket of the mini USB adapter cable (2). Observe the correct orientation (markings).

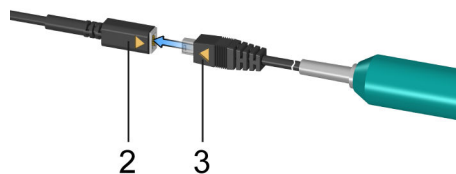

Figure 17 Plugging in the 854 iConnect

As soon as the instrument is switched on, the 854 iConnect is detected automatically and entered as measuring input into the device properties.

Connecting the electrode

The 854 iConnect is used as measuring input for iTrodes (electrodes with integrated memory chip).

Connect the electrode as follows:

- 1 Remove the protective cap of the 854 iConnect.

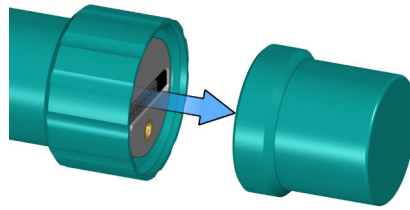

Figure 18 Removing the protective cap

- 2 Align the guide pin (5) of the electrode with the recess in the 854 iConnect (4).

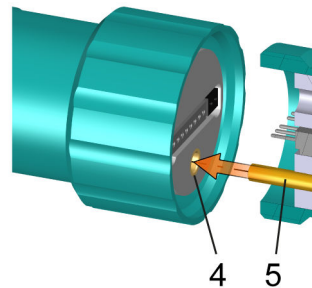

Figure 19 Aligning the guide pin

- 3 Attach the electrode to the 854 iConnect.

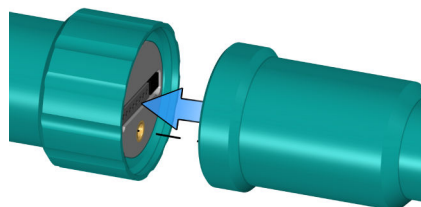

Figure 20 Attaching the electrode

The guide pin guarantees correct connection in such a way that the contact pins cannot be damaged.

- 4 Tighten the screw cap by hand.

If there is an electrode in the sensor list of the firmware or software, the electrode is detected automatically when connecting it.

**NOTE**

Mount the protective cap again as soon as the 854 iConnect is not in use anymore and no electrode is connected.

Removing the 854 iConnect

The 854 iConnect can also be removed while the instrument is switched on.

- 1 Unplug the 854 iConnect (3) from the socket of the mini USB adapter cable (2).

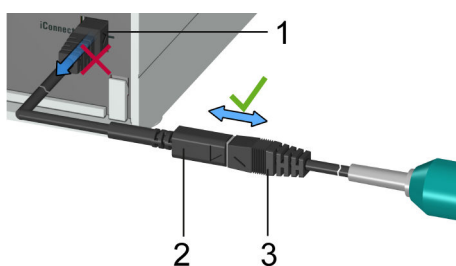

Figure 21 Unplugging the 854 iConnect

- 2 Leave the mini USB adapter cable (2) plugged into the socket of the instrument (1).

**NOTE**

Position the mini USB adapter cable in such a way that it cannot be removed by accident.

**NOTE**

For further information on the 854 iConnect, see *Manual iConnect 854*, article number 8.854.8002.

5 Operation and maintenance

5.1 General notes

5.1.1 Care

The 867 pH Module requires appropriate care. Excess contamination of the instrument may result in functional disruptions and a reduction in the lifetime of the otherwise sturdy mechanics and electronics.

Spilled chemicals and solvents should be removed immediately. Above all, the plug connections on the rear of the instrument (in particular the power socket) should be protected from contamination.



CAUTION

Although this is largely prevented by design measures, the power plug should be unplugged immediately if aggressive media have found their way into the interior of the instrument to prevent serious damage to the instrument electronics. In such cases, Metrohm Service must be informed.

5.1.2 Maintenance by Metrohm Service

Maintenance of the 867 pH Module is best carried out as part of annual service, which is performed by specialist personnel from Metrohm. A shorter maintenance interval may be necessary if you frequently work with caustic and corrosive chemicals.

Metrohm Service provides professional technical consultation at all times for the maintenance and servicing of all Metrohm instruments.

Problem	Cause	Remedy
	<i>The measuring chain is defective.</i>	Replace the measuring chain.
Sluggish measured value setting.	<i>The pH or ISE membrane or the diaphragm is contaminated.</i>	Clean the membrane or the diaphragm.
Insufficient slope during calibration.	<i>The pH or ISE membrane or the diaphragm is contaminated.</i>	Clean the membrane or the diaphragm.
	<i>No hydrated layer is present on the glass membrane after measurements in water-free solutions.</i>	Between measurements, place separate electrodes in distilled water and combined electrodes in reference electrolyte.
	<i>The buffer or standard solutions are old.</i>	Use fresh buffer or standard solutions.
	<i>The electrode is worn out.</i>	Replace the electrode.
The Delta U potential step set is not achieved with 'auto' standard addition.	<i>The streaming potential of the indicator electrode or reference electrode results in a potential difference between stirred addition and non-stirred measurement.</i>	<ul style="list-style-type: none"> ▪ Reduce the dosing rate. ▪ Increase the stirring rate. ▪ Increase Delta U. ▪ Touch Control: Select Addition = auto dos.



7 Appendix

7.1 Remote interface

The 6.2148.010 Remote Box allows devices to be controlled which cannot be connected directly to the MSB interface of the pH Module.

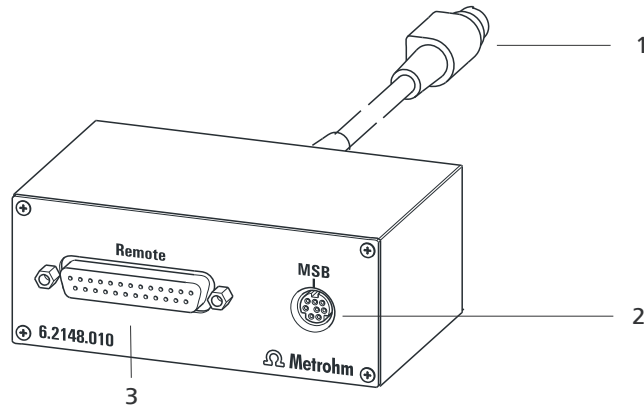

Figure 22 Connectors of the Remote Box

- | | |
|--|---|
| <p>1 Cable
For connecting to the pH Module.</p> | <p>2 MSB connector
Metrohm Serial Bus. For connecting external dosing devices or stirrers.</p> |
| <p>3 Remote connector
For connecting instruments with a remote interface.</p> | |

7.1.1 Pin assignment of the remote interface

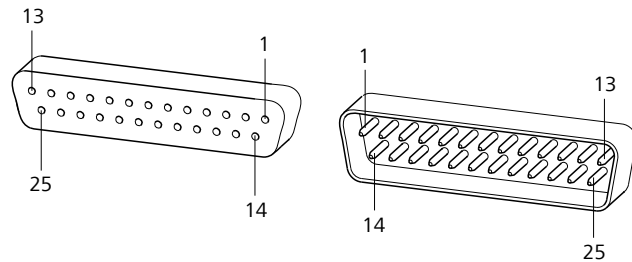
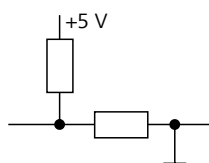

Figure 23 Pin assignment of remote socket and remote plug

The above figure of the pin assignment applies for all Metrohm instruments with 25-pin D-Sub remote connector.

Inputs



approx. 50 k Ω Pull-up

$t_p > 20$ ms

active = low, inactive = high

Outputs

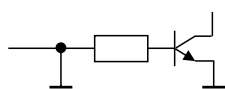

Open Collector

$t_p > 200$ ms

active = low, inactive = high

$I_C = 20$ mA, $V_{CE0} = 40$ V

+5 V: maximum load = 20 mA

The following tables offer information concerning the assignment of the individual pins and their function:

Table 1 Inputs and outputs of the remote interface

Assignment	Pin No.	Function*
Input 0	21	Start
Input 1	9	Stop
Input 2	22	
Input 3	10	Quit
Input 4	23	–
Input 5	11	
Input 6	24	
Input 7	12	
Output 0	5	Ready
Output 1	18	Conditioning OK
Output 2	4	Determination
Output 3	17	EOD
Output 4	3	
Output 5	16	Error
Output 6	1	
Output 7	2	Warning



Assignment	Pin No.	Function*
Output 8	6	
Output 9	7	
Output 10	8	
Output 11	13	
Output 12	19	
Output 13	20	
0 volts / GND	14	
+5 volts	15	
0 volts / GND	25	

* Signal activated only for operation with Touch Control.

Table 2 Explanation of the individual functions

Function	Explanation
Start	The current method is started at the time of activation. $t_{\text{pulse}} > 100 \text{ ms}$
Stop	The current method is canceled (Stop) at the time of activation. $t_{\text{pulse}} > 100 \text{ ms}$
Quit	The current command in the determination run will be canceled at the time of activation. $t_{\text{pulse}} > 100 \text{ ms}$
Ready	The instrument is ready to receive a start signal.
Conditioning OK	The line is set when Conditioning with SET titration and KFT titration is at OK. The line remains set until the determination is started with [START] .
Determination	The instrument performs a data-generating determination.
EOD	End of Determination. Pulse ($t_{\text{pulse}} = 200 \text{ ms}$) after a determination or after a buffer/standard solution during calibration using a Sample Processor.
Error	The line is set for error message display.



Function	Explanation
Warning	The line is set for warning message display.



8 Technical specifications

8.1 Measuring interface

The 867 pH Module has one galvanically isolated measuring interface.

The measuring cycle is 100 ms for all measuring modes.

8.1.1 Potentiometry

One high-ohm measuring input (**Ind.**) for pH, metal or ion-selective electrodes and one measuring input (**Ref.**) for separate reference electrodes.

<i>Input resistance</i>	$> 1 \cdot 10^{12} \Omega$
<i>Offset current</i>	$< 1 \cdot 10^{-12} \text{ A}$ (under reference conditions)
<i>Measuring mode</i>	
pH	
<i>Measuring range</i>	-13 to +20 pH
<i>Resolution</i>	0.001 pH
<i>Measuring accuracy</i>	$\pm 0.003 \text{ pH}$ (± 1 digit, without sensor error, under reference conditions)
<i>Measuring mode</i>	
U	
<i>Measuring range</i>	-1,200 to +1,200 mV
<i>Resolution</i>	0.1 mV
<i>Measuring accuracy</i>	$\pm 0.2 \text{ mV}$ (± 1 digit, without sensor error, under reference conditions)
<i>Measuring mode</i>	
Conc	
<i>Measuring range</i>	$10^{-21} - 10^{20}$
<i>Resolution</i>	
<i>Measuring accuracy</i>	(± 1 digit, without sensor error, under reference conditions)

8.1.2 Temperature

A measuring input (**Temp.**) for temperature sensors of the Pt1000 or NTC type with automatic temperature compensation.

R (25 °C) and B value can be configured for NTC sensors.

Measuring range

Pt1000	−150 to +250 °C
NTC	−5 to +250 °C (R (25 °C) = 30,000 Ω and B (25/50) = 4,100 K)

Resolution

Pt1000	0.1 °C
NTC	0.1 °C

Measuring accuracy

Pt1000	±0.2 °C (Applies for measuring range −20 to +150 °C; ±1 digit; without sensor error, under reference conditions)
NTC	±0.6 °C (Applies for measuring range +10 to +40 °C; ±1 digit; without sensor error, under reference conditions)

8.1.3 Polarizer

One measuring input (**Pol.**) for polarizable electrodes.

Measuring mode *I_{pol}*

Determination with adjustable polarization current

Polarization current	−122.5 to +122.5 μA (increment: 0.5 μA) −125.0 to +125.0 μA: non-guaranteed values, dependent on reference voltage +2.5 mV
----------------------	---

Measuring range	−1,200 to +1,200 mV
-----------------	---------------------

Resolution	0.1 mV
------------	--------

Measuring accuracy	±0.2 μA (±1 digit; without sensor error, under reference conditions)
--------------------	---

Measuring mode *U_{pol}*

Determination with adjustable polarization voltage

Polarization voltage	−1,225 to +1,225 mV (increment: 25 mV) −1,250 to +1,250 mV: non-guaranteed values, dependent on reference voltage +2.5 mV
----------------------	--

Measuring range	−120 to +120 μA
-----------------	-----------------

8.2 Power connection



<i>Resolution</i>	0.01 μ A
<i>Measuring accuracy</i>	—

8.2 Power connection

<i>Supply voltage</i>	100–240 V (\pm 10%)
<i>Frequency</i>	50–60 Hz (\pm 3%)
<i>Power consumption</i>	45 W
<i>Fuse</i>	2 x 1.6 ATH

8.3 Ambient conditions

Automatic interior temperature monitoring

<i>Nominal function range</i>	+5 to +45 °C at max. 80% relative humidity, non-condensing
<i>Storage</i>	+5 to +45 °C at max. 80% relative humidity, non-condensing
<i>Altitude / Pressure range</i>	max. 2,000 m.a.s.l. sea level / min. 780 mbar
<i>Overvoltage category</i>	II
<i>Pollution degree</i>	2

8.4 Reference conditions

<i>Ambient temperature</i>	+25 °C (\pm 3 °C)
<i>Relative humidity</i>	\leq 60%
<i>Device status</i>	Device in operation at least 30 min
<i>Validity of the data</i>	After adjustment

8.5 Dimensions

<i>Width</i>	142 mm
<i>Height</i>	108 mm
<i>Depth</i>	230 mm
<i>Weight</i>	2.7 kg (without accessories)
<i>Material</i>	Steel sheet

8.6 Interfaces

USB connectors

<i>USB ports</i>	2 USB downstream ports (type A sockets), 500 mA each, for connecting peripheral devices such as printers, keyboards, barcode readers or RS-232/USB boxes (Metrohm order no. 6.2148.020).
------------------	--

"Controller" connector

<i>Controller port</i>	USB upstream port with auxiliary power supply (Mini DIN socket) for connecting Touch Control or computer for controlling the 867 pH Module.
------------------------	---

Touch Control With integrated Touch Control cable.

Computer With 6.2151.000 cable.

MSB connectors (Metrohm Serial Bus)

<i>Dosing device</i>	Connection of a maximum of 4 external dosing devices, models Dosi-mat or Dosino (MSB 1 to MSB 4).
----------------------	---

<i>Stirrer</i>	Connection of a maximum of 4 stirrers. Stirrer control: Switching on/off manually or coordinated with the titration sequence. Speed in 15 steps and shift direction can be selected.
----------------	--

<i>Remote Box</i>	Connection of a maximum of 4 Remote Boxes. Remote Boxes can be used to actuate and monitor external devices.
-------------------	--

