

846 Dosing Interface



Manual

8.846.8001EN / v6 / 2025-09-12



Metrohm AG
CH-9100 Herisau
Switzerland
+41 71 353 85 85
info@metrohm.com
www.metrohm.com

846 Dosing Interface

Manual

Technical Communication
Metrohm AG
CH-9100 Herisau

This documentation is protected by copyright. All rights reserved.

This documentation has been prepared with great care. However, errors can never be entirely ruled out. Please send comments regarding possible errors to the address above.

Disclaimer

Deficiencies arising from circumstances that are not the responsibility of Metrohm, such as improper storage or improper use, etc., are expressly excluded from the warranty. Unauthorized modifications to the product (e.g. conversions or attachments) exclude any liability on the part of the manufacturer for resulting damage and its consequences. Instructions and notes in the Metrohm product documentation must be strictly followed. Otherwise, Metrohm's liability is excluded.

Table of contents

1	Introduction	1
1.1	The 846 Dosing Interface in the Titrand system	1
1.2	Instrument description	2
1.3	Commands	3
1.4	Intended use	3
1.5	About the documentation	3
1.5.1	Symbols and conventions	3
1.6	Safety instructions	5
1.6.1	General notes on safety	5
1.6.2	Electrical safety	5
1.6.3	Tubing and capillary connections	6
1.6.4	Flammable solvents and chemicals	6
1.6.5	Recycling and disposal	6
2	Overview of the instrument	8
3	Installation	10
3.1	Setting up the instrument	10
3.1.1	Packaging	10
3.1.2	Checks	10
3.1.3	Location	10
3.2	Stacking instruments	10
3.3	Connecting the instrument to the power grid	11
3.4	Connecting a computer	12
3.5	Connecting MSB devices	14
3.5.1	Connecting a dosing device	15
3.5.2	Connecting a stirrer or titration stand	16
3.5.3	Connecting a Remote Box	17
3.6	Connecting USB devices	18
3.6.1	General	18
3.6.2	Connecting a USB hub	19
3.6.3	Connecting a printer	19
3.6.4	Connecting a balance	20
3.6.5	Connecting a PC keyboard (only for operation with Touch Control)	21
3.6.6	Connecting a barcode reader	22
4	Handling and maintenance	24



5	Appendix	25
5.1	Remote interface	25
5.1.1	Pin assignment of the remote interfaces	25
5.2	Stirring rate	27
6	Technical specifications	28
6.1	Power connection	28
6.2	Interfaces and connectors	28
6.3	Reference conditions	29
6.4	Ambient conditions	29
6.5	Dimensions	29
7	Accessories	30
	Index	31

Table of figures

Figure 1	The 846 Dosing Interface in the Titrando system	1
Figure 2	846 Dosing Interface Front	8
Figure 3	846 Dosing Interface Rear	9
Figure 4	846 Dosing Interfaces with bottle holder 6.2061.010 or with Titrando, respectively	11
Figure 5	Connecting the computer	13
Figure 6	MSB connections	14
Figure 7	Connecting a dosing device	16
Figure 8	Connecting an MSB stirrer	17
Figure 9	Connecting the rod stirrer to the titration stand	17
Figure 10	Connecting the Remote Box	18
Figure 11	Connecting a printer	20
Figure 12	Connectors of the Remote Box	25
Figure 13	Pin assignment of remote socket and remote plug	25
Figure 14	Rotational speed depending on the stirring rate	27

1 Introduction

1.1 The 846 Dosing Interface in the Titrando system

The 846 Dosing Interface is a component of the modular Titrando system. It is operated either by means of a Touch Control with a touch-sensitive screen or through a computer with a corresponding software, e.g. **tiamo™** or **MagIC Net™**.

A Titrando system can contain numerous, various kinds of instruments. The following figure provides an overview of the peripheral devices you can connect to the 846 Dosing Interface.

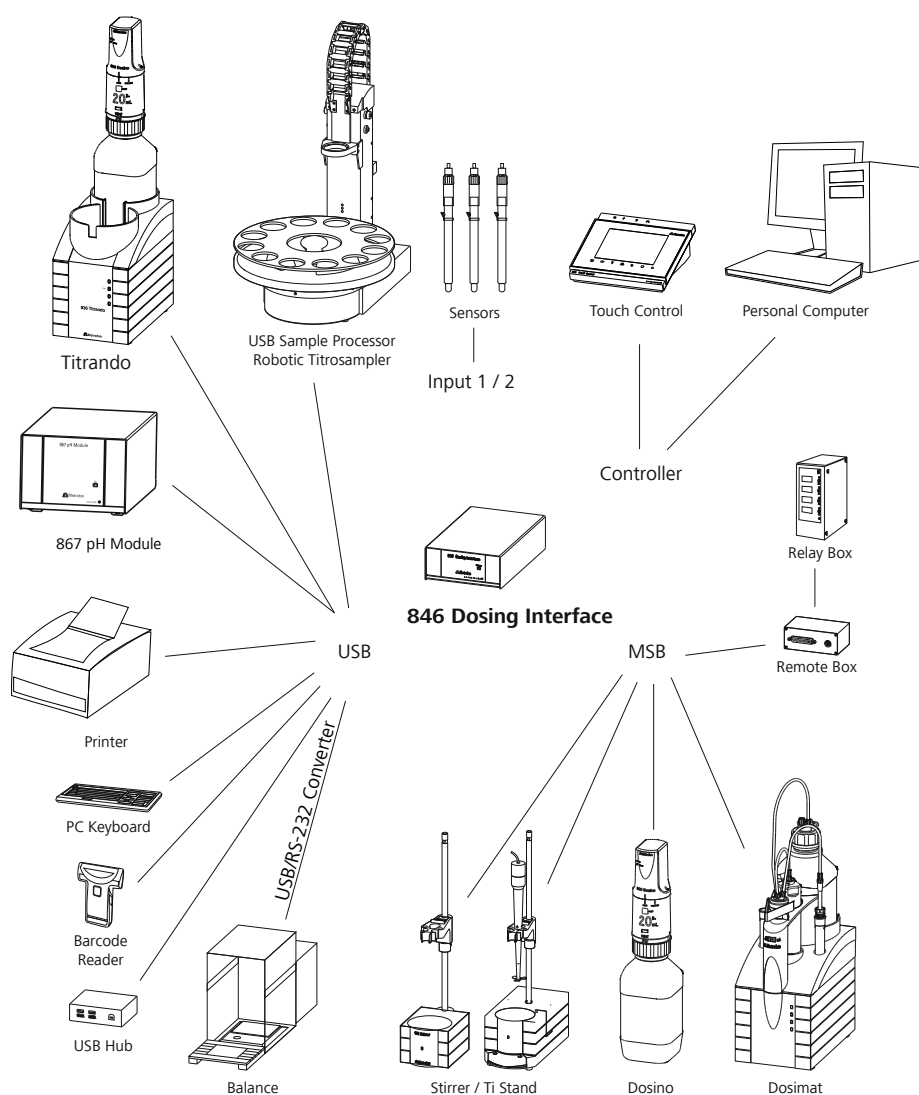

Figure 1 The 846 Dosing Interface in the Titrando system



When a Touch Control is used as the operating unit, up to 3 control instruments (Titrandos, Dosing Interfaces, USB Sample Processors, etc.) can be controlled via USB connection. If a PC software (**tiamo™** or **MagIC Net™**) is used, then there is no limit to the number of control instruments that can be used to extend the system.

Updating the device software is described in the manual for the Touch Control or in the online help for the control software.

1.2 Instrument description

The 846 Dosing Interface is a very versatile instrument. It was designed exclusively for operational and laboratory use and covers a wide spectrum of applications in this context.

Because it is equipped with high-performance USB interfaces, it can be fitted seamlessly in a Titrandos system from Metrohm. The versatile communications options of the Titrandos system (Remote Box, LIMS link, etc.) can thus all be used. Thanks to these capabilities, a 846 Dosing Interface is predestined for all imaginable dosing and liquid handling tasks in modern laboratory operations, particularly within highly integrated laboratory data systems.

The user interface of the Touch Control or of the **tiamo™** or **MagIC Net™** software ensures convenient operation and programming of the 846 Dosing Interface. The integration in the Titrandos system also ensures 100% conformance with the guidelines of the FDA (Food and Drug Administration) for the entire instrument system, in particular with Guideline 21 CFR, Part 11, Electronic records and signatures.

The 846 Dosing Interface has the following features:

- **Operation**
Operation is carried out by means of a touch-sensitive Touch Control or with a high-performance computer software such as **tiamo™**.
- **Dosing**
Dosinos and Dosimats can be used for dosing. These enable the dosing of auxiliary solutions or the carrying out of complex liquid handling tasks.
- **MSB connectors**
Four MSB connectors (Metrohm Serial Bus) are available for controlling Dosinos, stirrers and Remote Boxes.
- **USB connectors**
Two USB connectors, with which devices such as printers, PC keyboards, barcode readers or additional control instruments (Titrandos, USB Sample Processor, Dosing Interface, etc.) can be connected.

1.3 Commands

The following commands are supported:

- **Dosing commands**
Commands for dosing fixed volumes and for preparing and emptying dosing units and/or exchange units.
 - **ADD** (adding a predefined volume)
 - **PREP** (preparing and rinsing cylinders and tubing)
 - **EMPTY** (for emptying cylinder and tubings)
 - **LQH** (for executing complex dosing tasks)
- **Other commands**
 - **STIR** (stirrer control)
 - **SCAN** (scanning remote signals)
 - **CTRL** (setting remote signals)

1.4 Intended use

The 846 Dosing Interface is designed for usage as a dosing device in analytical laboratories. It can be used everywhere where complex liquid handling tasks must be carried out.

This instrument is suitable for processing chemicals and flammable samples. Therefore, the use of the 846 Dosing Interface requires the user to have basic knowledge and experience in handling toxic and caustic substances. Knowledge regarding the application of fire prevention measures prescribed for laboratories is also mandatory.

1.5 About the documentation



CAUTION

Please read through this documentation carefully before putting the instrument into operation. The documentation contains information and warnings which the user must follow in order to ensure safe operation of the instrument.







1.5.1 Symbols and conventions

The following symbols and formatting may appear in this documentation:

(5-**12**)

Cross-reference to figure legend

The first number refers to the figure number, the second to the instrument part in the figure.

1	Instruction step Perform the steps one after the other.
Method	Dialog text, parameter in the software
File ► New	Menu or menu item
[Continue]	Button or key
	WARNING This symbol draws attention to a possible life-threatening hazard or risk of injury.
	WARNING This symbol draws attention to a possible hazard due to electrical current.
	WARNING This symbol draws attention to a possible hazard due to heat or hot instrument parts.
	WARNING This symbol draws attention to a possible biological hazard.
	WARNING Warning of optical radiation
	CAUTION This symbol draws attention to possible damage to instruments or instrument parts.
	NOTICE This symbol highlights additional information and tips.

1.6 Safety instructions

1.6.1 General notes on safety



WARNING

Operate this instrument only according to the information contained in this documentation.

This instrument left the factory in a flawless state in terms of technical safety. To maintain this state and ensure non-hazardous operation of the instrument, the following instructions must be observed carefully.

1.6.2 Electrical safety

The electrical safety when working with the instrument is ensured as part of the international standard IEC 61010.



WARNING

Only personnel qualified by Metrohm are authorized to carry out service work on electronic components.



WARNING

Never open the housing of the instrument. The instrument could be damaged by this. There is also a risk of serious injury if live components are touched.

There are no parts inside the housing which can be serviced or replaced by the user.

Supply voltage



WARNING

An incorrect supply voltage can damage the instrument.

Only operate this instrument with a supply voltage specified for it (see rear panel of the instrument).

Protection against electrostatic charges



WARNING

Electronic components are sensitive to electrostatic charges and can be destroyed by discharges.

Do not fail to pull the power cord out of the power socket before you set up or disconnect electrical plug connections at the rear of the instrument.

1.6.3 Tubing and capillary connections



CAUTION

Leaks in tubing and capillary connections are a safety risk. Tighten all connections well by hand. Avoid applying excessive force to tubing connections. Damaged tubing ends lead to leakage. Appropriate tools can be used to loosen connections.

Check the connections regularly for leakage. If the instrument is used mainly in unattended operation, then weekly inspections are mandatory.

1.6.4 Flammable solvents and chemicals



WARNING

All relevant safety measures are to be observed when working with flammable solvents and chemicals.

- Set up the instrument in a well-ventilated location.
- Keep all sources of flame far from the workplace.
- Clean up spilled liquids and solids immediately.
- Follow the safety instructions of the chemical manufacturer.

1.6.5 Recycling and disposal



This product is covered by European Directive 2012/19/EU, WEEE – Waste Electrical and Electronic Equipment.

The correct disposal of your old instrument will help to prevent negative effects on the environment and public health.





More details about the disposal of your old instrument can be obtained from your local authorities, from waste disposal companies or from your local dealer.

2 Overview of the instrument

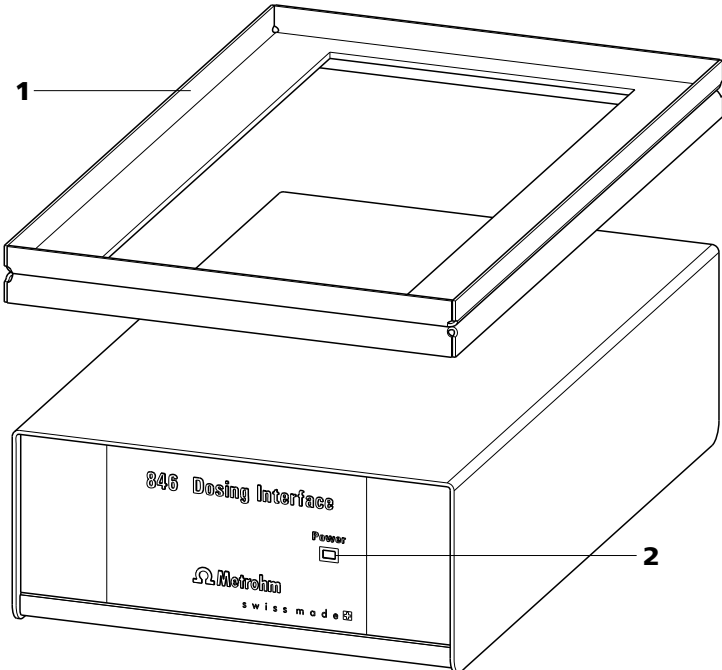

Figure 2 846 Dosing Interface Front

1 Stacking frame (6.2065.000, optional)
For the secure stacking of several Dosing Interfaces or one bottle holder.

2 LED "On"
Lights up when the Dosing Interface and a controller (Touch Control or computer) are connected to the mains and switched on.

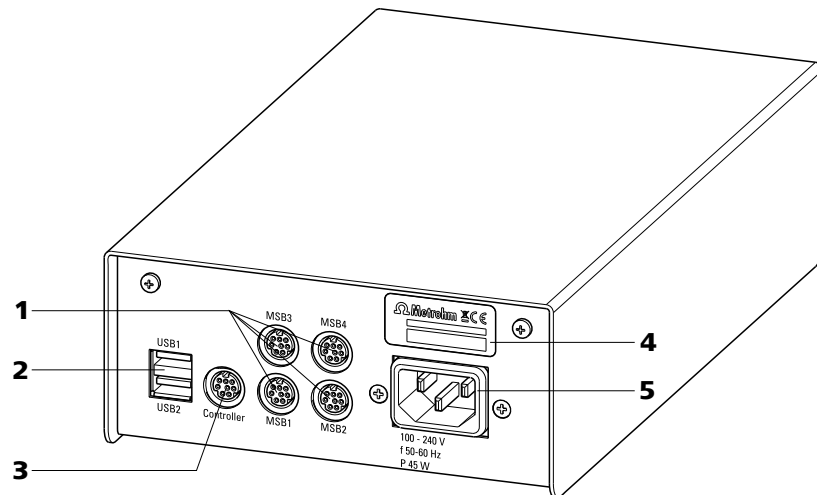

Figure 3 846 Dosing Interface Rear

1 MSB connector (MSB 1 to MSB 4)
Metrohm Serial Bus. For connecting external dosing devices, stirrers or Remote Boxes. Mini DIN, 9-pin.

3 Controller connector (Controller)
For connecting Touch Control or PC with installed PC software. Mini DIN, 9-pin.

5 Mains connection socket

2 USB connector (USB 1 and USB 2)
USB ports (type A) for connecting printer, keyboard, barcode reader, USB Sample Processor, etc.

4 Type plate
Contains specifications concerning mains voltage, instrument type and serial number.

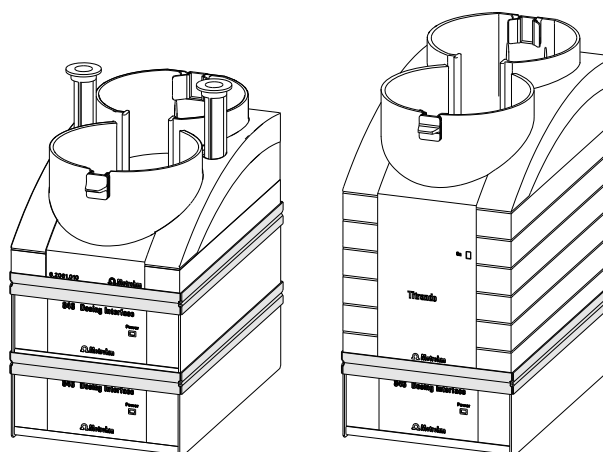

Figure 4 846 Dosing Interfaces with bottle holder 6.2061.010 or with Titrando, respectively

3.3 Connecting the instrument to the power grid



WARNING

Electric shock from electrical potential

Risk of injury by touching live components or through moisture on live parts.

- Never open the housing of the instrument while the power cord is still connected.
- Protect live parts (e.g. power supply unit, power cord, connection sockets) against moisture.
- Unplug the power plug immediately if you suspect that moisture has gotten inside the instrument.
- Only personnel who have been issued Metrohm qualifications may perform service and repair work on electrical and electronic parts.

Connecting the power cord

Accessories

Power cord with the following specifications:

- Length: max. 2 m
- Number of cores: 3, with protective conductor
- Instrument plug: IEC 60320 type C13
- Conductor cross-section 3x min. 1.0 mm² / 18 AWG
- Power plug:
 - according to customer requirement (6.2122.XX0)
 - min. 10 A

**NOTE**

Do not use a not permitted power cord!

1 Plugging in the power cord

- Plug the power cord into the instrument's power socket.
- Connect the power cord to the power grid.

3.4 Connecting a computer

The 846 Dosing Interface requires a USB connection to a computer in order to be able to be controlled by a computer software. Using a 6.2151.000 controller cable, the instrument can be connected directly, either to a USB socket on a computer, to a connected USB hub or to a different Metrohm control instrument.

You need administrator rights for the installation of driver software and control software on your computer.

Cable connection and driver installation

A driver installation is required in order to ensure that the 846 Dosing Interface is recognized by the computer software. To accomplish this, you must comply with the procedures specified. The following steps are necessary:

1 Install the software

- Insert the computer software installation CD and carry out the installation program directions.
- Exit the program if you have started it after the installation.

2 Establishing the cable connections

- Connect all peripheral devices to the instrument, *see Chapter 3.5, page 14* and *see Chapter 3.6, page 18*.
- Connect the instrument to the power grid if you have not already done this (*see chapter 3.3, page 11*).
The "On" LED on the 846 Dosing Interface is not yet illuminated!
- Connect the instrument to a USB connector (type A) of your computer (see manual of your computer). The 6.2151.000 cable is used for this purpose.

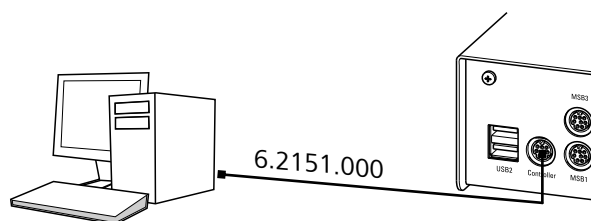

Figure 5 Connecting the computer

The instrument is recognized. Depending on the version of the Windows operating system used, the driver installation proceeds differently afterwards. Either the necessary driver software is installed automatically or an installation wizard is started.

3 Follow the instructions of the installation wizard.

The "On" LED on the 846 Dosing Interface lights up when the driver installation has been completed and the instrument is ready for operation.

If problems should occur during installation, contact your company's IT support team.



NOTE

The plug on the instrument end of the 6.2151.000 controller cable is protected against accidental disconnection by means of a pull-out protection feature. If you wish to pull out the plug, you first need to pull back the outer plug sleeve marked with arrows.

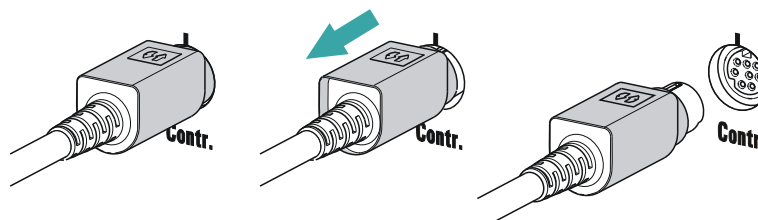

Registering and configuring the instrument in the computer software

The instrument must be registered in the configuration of your computer software. Once that has been done, you can then configure it according to your requirements. Proceed as follows:

1 Setting up the instrument

- Start the computer software.
The instrument is automatically recognized. The configuration dialog for the instrument is displayed.

**NOTE**

When connecting MSB devices together, the following must be observed:

- Only one device of the same type can be used at a single MSB connector at one time.
- Dosing devices of the 700 Dosino and 685 Dosimat plus type cannot be connected together with other MSB devices on a shared connector. These dosing devices must be connected separately.

**CAUTION**

Exit the control software before you plug in MSB devices. When it is switched on, the control instrument automatically recognizes which device is connected to which MSB connector. The operating unit or the control software enters the connected MSB devices into the system configuration (device manager).

MSB connections can be extended with the 6.2151.010 cable. The maximum connection length permitted is 15 m.

3.5.1 Connecting a dosing device

Four dosing devices can be connected to the instrument (**MSB 1 to MSB 4**).

The types of dosing devices that are supported are:

- 800 Dosino
- 700 Dosino
- 805 Dosimat
- 685 Dosimat plus

Proceed as follows:

1 Connecting a dosing device

- Exit the control software.
- Connect the connection cable of the dosing device to one of the sockets marked with **MSB** on the rear of the control device.
- Start the control software.

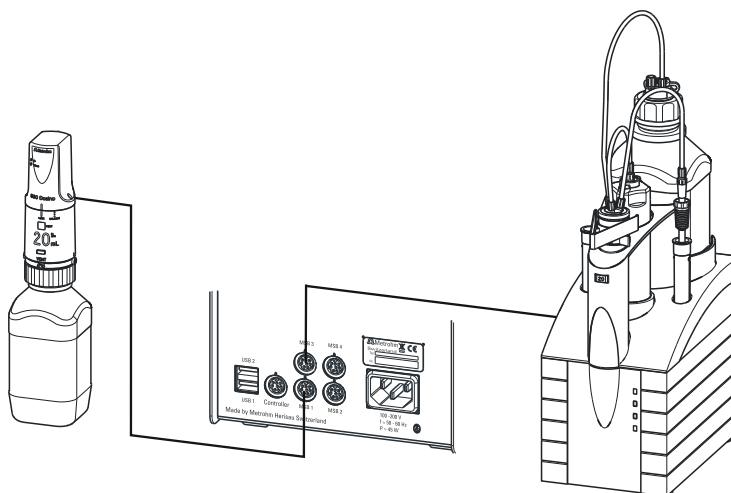

Figure 7 Connecting a dosing device

3.5.2 Connecting a stirrer or titration stand

You can use the following instruments:

These devices have a built-in magnetic stirrer (stirring "from below"):

- 801 Stirrer
- 803 Ti Stand

This device has no built-in magnetic stirrer (stirring "from above"):

- 804 Ti Stand with rod stirrer 802 Stirrer

Connect a stirrer or a titration stand as follows:

1 Connecting the stirrer or titration stand

- Exit the control software.
- Connect the connection cable of the magnetic stirrer or of the titration stand to one of the sockets marked with **MSB** on the rear of the control instrument.
- 804 Ti Stand only: Connect the rod stirrer to the stirrer connector (socket with stirrer symbol) of the titration stand.
- Start the control software.

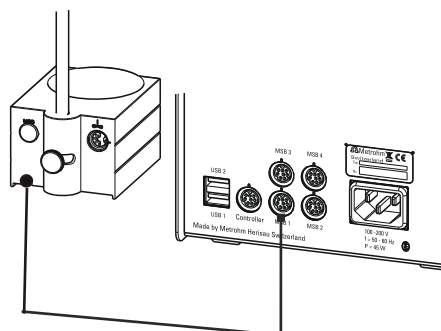

Figure 8 Connecting an MSB stirrer

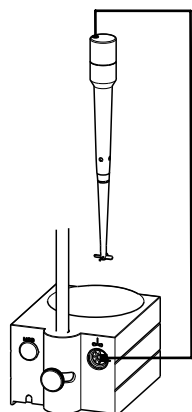

Figure 9 Connecting the rod stirrer to the titration stand

3.5.3 Connecting a Remote Box

Instruments that are controlled via remote lines and/or that send control signals via remote lines can be connected via the 6.2148.010 Remote Box. In addition to Metrohm, other instrument manufacturers also use similar connectors that make it possible to connect different instruments together. These interfaces are also frequently given the designations "TTL Logic", "I/O Control" or "Relay Control" and they generally have a signal level of 5 volts.

Control signals are understood to be electrical line statuses or electrical pulses (> 200 ms) which display the operating status of an instrument or which trigger or report an event. Sequences on a variety of instruments can thus be coordinated in a single complex automation system. However, no exchange of data is possible.

Proceed as follows:

1 Connecting the Remote Box

- Exit the control software.
- Connect the Remote Box connection cable to one of the sockets marked with **MSB** on the rear of the control instrument.
- Start the control software.

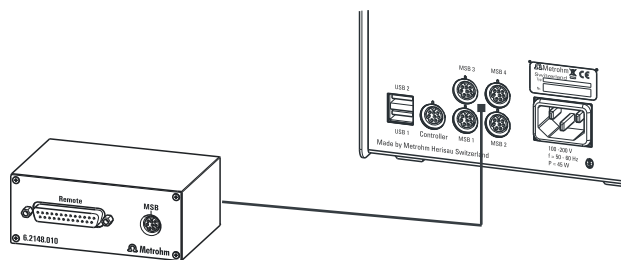

Figure 10 Connecting the Remote Box

You can connect the following instruments to the remote connector, among others:

- 849 Level Control (fill level monitoring in a canister)
- 731 Relay Box (switch box for 230/110 volt alternating current sockets and low-voltage direct current outlets)
- 843 Pump Station (for complex sample preparations or for rinsing external titration vessels)

The Remote Box also has an MSB socket at which a further MSB device, e.g. a dosing device or a stirrer, can be connected.

You will find precise information concerning the pin assignment of the interface on the Remote Box in the *appendix*.

3.6 Connecting USB devices

3.6.1 General

The 846 Dosing Interface has two USB connectors (type A sockets) for peripheral devices with USB interfaces. The 846 Dosing Interface functions as a USB hub (distributor) no matter how it is operated. If you wish to connect more than two devices to the USB, you can also use an additional, commercially available USB hub.



CAUTION

If you operate the 846 Dosing Interface with the aid of the Touch Control, take care to ensure that the Touch Control is switched off when you set up or disconnect connections between the various instruments. If you use a PC software to control the 846 Dosing Interface, you should exit the program before you set up or disconnect the USB connections.

3.6.2 Connecting a USB hub

If you wish to connect more than two devices to the USB connector of the 846 Dosing Interface, you can also use an additional commercially available USB hub (distributor). If you operate the 846 Dosing Interface with the help of the Touch Control, then you should use a USB hub with its own power supply.

Connect the USB hub as follows:

- 1 Switch off the Touch Control and/or exit the PC software.
- 2 With the aid of the 6.2151.020 cable, connect the USB connector of the 846 Dosing Interface (type A) with the USB connector of the hub (type B, see manual for the hub).
- 3 Switch on the Touch Control.

The USB hub is recognized automatically.

3.6.3 Connecting a printer

Printers that are connected to the 846 Dosing Interface with Touch Control must meet the following requirements:

- Printer languages: HP-PCL (PCL 3 to 5, PCL 3GUI), Canon BJL Commands or Epson ESC P/2
- Printer resolution: 300 dots/inch or 360 dots/inch (Epson)
- Paper size: A4 or Letter, single-sheet feed.

Connect the printer as follows:

- 1 Switch off the Touch Control.
- 2 With the aid of the 6.2151.020 cable, connect the USB connector of the 846 Dosing Interface (type A) with the USB connector of the printer (type B, see manual for the printer).
- 3 Switch on the printer first, then the Touch Control.
- 4 Configure the printer in the device manager of the Touch Control (see Touch Control manual).

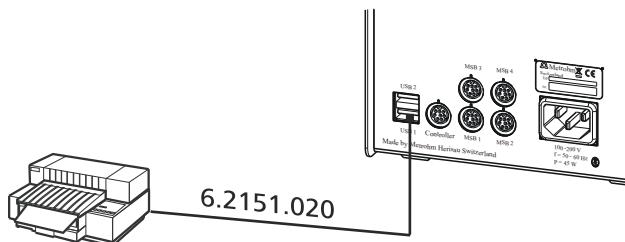

Figure 11 Connecting a printer

3.6.4 Connecting a balance

- Operation with a PC software:
 - Connect the balance directly to the serial connector (COM) of the computer. This is usually 9-pin and marked with the symbol **IOIOI**.
- Operation with Touch Control:
 - You will need the 6.2148.050 USB/RS-232 adapter to connect a balance.

The following table offers an overview of the balances that you can use together with the 846 Dosing Interface and of which cable you will need for connection to the RS-232 interface:

Balance	Cable
AND ER, FR, FX with RS-232 interface (OP-03)	6.2125.020 + 6.2125.010
Mettler AB, AG, PR (LC-RS9)	In the scope of delivery for the balance
Mettler AM, PM, PE with interface option 016 or Mettler AJ, PJ with interface option 018	6.2146.020 + 6.2125.010 Also from Mettler: ME 47473 adapter and either ME 42500 hand switch or ME 46278 foot switch
Mettler AT	6.2146.020 + 6.2125.010 Also from Mettler: ME 42500 hand switch or ME 46278 foot switch
Mettler AX, MX, UMX, PG, AB-S, PB-S, XP, XS	6.2134.120
Mettler AE with interface option 011 or 012	6.2125.020 + 6.2125.010 Also from Mettler: ME 42500 hand switch or ME 46278 foot switch

Balance	Cable
Ohaus Voyager, Explorer, Analytical Plus	Cable AS017-09 from Ohaus
Precisa balances with RS-232-C interface	6.2125.080 + 6.2125.010
Sartorius MP8, MC, LA, Genius, Cubis	6.2134.060
Shimadzu BX, BW	6.2125.080 + 6.2125.010

Operation with Touch Control

Connect the balance as follows:

- 1 Plug in the USB plug of the USB/RS-232 adapter at the USB connector of the 846 Dosing Interface.
- 2 Connect the RS-232 interface of the USB/RS-232 adapter with the RS-232 interface of the balance (see table for cable).
- 3 Switch on the Touch Control.
- 4 Switch on the balance.
- 5 Activate the RS-232 interface of the balance if necessary.
- 6 Configure the RS-232 interface of the USB/RS-232 adapter in the device manager of the Touch Control (see Touch Control manual).

3.6.5 Connecting a PC keyboard (only for operation with Touch Control)

The PC keyboard is used as an aid for text and numerical input.

Connect the PC keyboard as follows:

- 1 Insert the USB plug of the keyboard into one of the USB sockets of the 846 Dosing Interface.
- 2 Switch on the Touch Control.

The keyboard is recognized automatically and entered in the device manager.



- 3 Configure the keyboard in the device manager of the Touch Control (see Touch Control manual).

3.6.6 Connecting a barcode reader

The barcode reader is used as an aid for text and numerical input. You can connect a barcode reader with USB interface.

Operation with Touch Control

Connect the barcode reader as follows:

- 1 Insert the USB plug of the barcode reader into one of the USB sockets of the 846 Dosing Interface.
- 2 Switch on the Touch Control.
The barcode reader is recognized automatically and entered in the device manager.
- 3 Configure the barcode reader in the device manager of the Touch Control (see Touch Control manual).

Settings on the barcode reader:

Program the barcode reader as follows (see also the manual for the barcode reader):

- 1 Switch the barcode reader to programming mode.
- 2 Specify the desired layout for the keyboard (USA, Germany, France, Spain, German-speaking Switzerland).
This setting must match the setting in the device manager (see the Touch Control manual).
- 3 Make sure that the barcode reader is set in such a way that Ctrl characters (ASCII 00 to 31) can be sent.
- 4 Program the barcode reader in such a way that the ASCII character 02 (STX or Ctrl B) is sent as the first character. This first character is normally referred to as the "Preamble" or "Prefix Code".
- 5 Program the barcode reader in such a way that the ASCII character 04 (EOT or Ctrl D) is sent as the last character. This last character is

4 Handling and maintenance

The 846 Dosing Interface requires appropriate care. Excess contamination of the instrument may result in functional disruptions and a reduction in the lifetime of the sturdy mechanics and electronics of the instrument.

Severe contamination can also have an influence on the measured results. Regular cleaning of exposed parts can prevent this to a large extent.

Spilled chemicals and solvents must be removed immediately. In particular, the mains plug should be protected from contamination.

5 Appendix

5.1 Remote interface

The 6.2148.010 Remote Box allows devices to be controlled which cannot be connected directly to the MSB interface of the Dosing Interface.

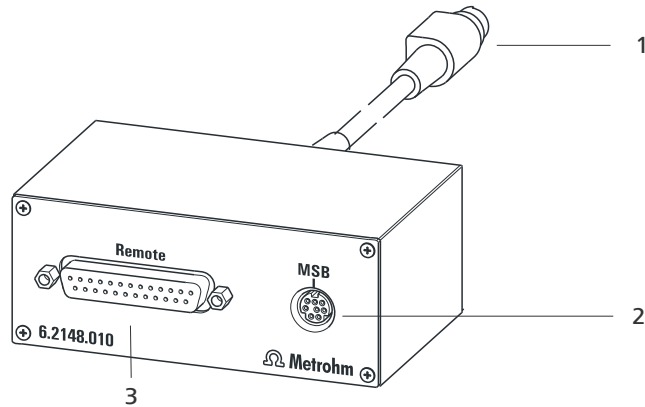

Figure 12 Connectors of the Remote Box

1 Cables

For connecting to an MSB connector of the Dosing Interface.

2 MSB connector

Metrohm Serial Bus. For connecting external dosing devices or stirrers.

3 Remote connector

For connecting instruments with a remote interface.

5.1.1 Pin assignment of the remote interfaces

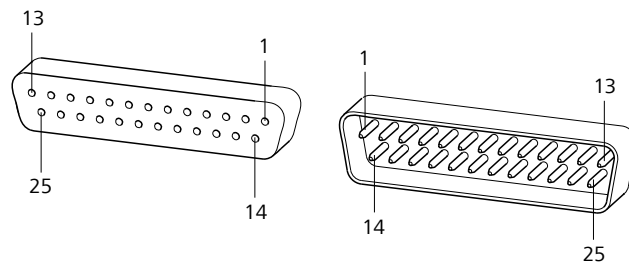
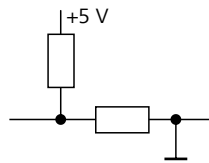

Figure 13 Pin assignment of remote socket and remote plug

The above figure of the pin assignment of a Metrohm remote interface does not only apply for the Remote Box, but also for all Metrohm devices with 25-pin D-Sub remote connectors.



Inputs



approx. 50 kΩ Pull-up
 $t_p > 20\text{ ms}$
 active = low, inactive = high

The input lines can be scanned with the **SCAN** command.

Outputs

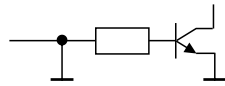

Open Collector
 $t_p > 200\text{ ms}$
 active = low, inactive = high
 $I_C = 20\text{ mA}$, $V_{CE0} = 40\text{ V}$
 +5 V: maximum load = 20 mA

The output lines can be set with the **CTRL** command.

Table 1 Inputs and outputs of the remote interface

Assignment	Pin no.	Assignment	Pin no.
Input 0	21	Output 0	5
Input 1	9	Output 1	18
Input 2	22	Output 2	4
Input 3	10	Output 3	17
Input 4	23	Output 4	3
Input 5	11	Output 5	16
Input 6	24	Output 6	1
Input 7	12	Output 7	2
0 volts / GND	14	Output 8	6
+5 volt	15	Output 9	7
0 volts / GND	25	Output 10	8
		Output 11	13
		Output 12	19
		Output 13	20

5.2 Stirring rate

The stirring rate can be adjusted in steps from -15 to +15.

The approximate rotational speed for the internal magnetic stirrer (depends on the product version) can be calculated with the following formula:

$$\text{Rotational speed/min (r/min)} = 125 \cdot \text{Stirring rate}$$

Example:

Configured stirring rate: 8

Rotational speed in revolutions per minutes = $125 \cdot 8 = 1,000$

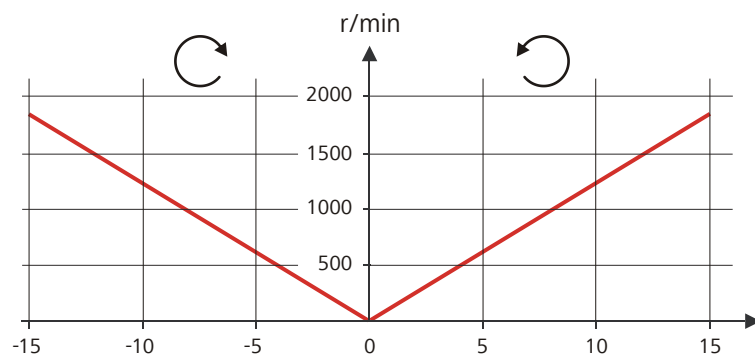

Figure 14 Rotational speed depending on the stirring rate

The information on the separately connectable 802 propeller stirrer can be found in the "802 Stirrer" manual.



6 Technical specifications

6.1 Power connection

<i>Voltage</i>	100–240 V (± 10%)
<i>Frequency</i>	50–60 Hz
<i>Power consumption</i>	Maximum 45 W
<i>Fuse</i>	Electronic overload protection

6.2 Interfaces and connectors

Controller connector

<i>Controller port</i>	USB upstream port with auxiliary power supply (Mini DIN socket) for connecting Touch Control or computer for controlling the 846 Dosing Interface.
<i>Touch Control</i>	With integrated Touch Control cable
<i>Computer</i>	With 6.2151.000 cable

USB connectors

<i>USB ports</i>	2 USB downstream ports (type A sockets), 500 mA each, for connecting peripheral devices such as printers, keyboards, barcode readers or RS-232/USB boxes (Metrohm order no. 6.2148.020).
<i>Controller port</i>	USB upstream port with auxiliary power supply (Mini DIN socket) for connecting Touch Control or computer for controlling the 846 Dosing Interface.
<i>Touch Control</i>	With integrated Touch Control cable
<i>Computer</i>	With 6.2151.000 cable

MSB connectors (Metrohm Serial Bus)

<i>Dosing device</i>	Connector for a maximum of 4 external dosing devices, models Dosi-mat or Dosino (MSB 1 to MSB 4).
<i>Stirrer</i>	Connection of a maximum of 4 stirrers. Rate in 15 steps, shift direction can be selected.
<i>Remote Box</i>	Connection of a maximum of 4 Remote Boxes. Remote Boxes can be used to actuate and monitor external devices.

6.3 Reference conditions

<i>Ambient temperature</i>	+25 °C (±3 °C)
<i>Relative humidity</i>	≤ 60%
<i>Device status</i>	Device in operation at least 30 min

6.4 Ambient conditions

<i>Automatic interior temperature monitoring</i>	
<i>Nominal function range</i>	+5 to +45 °C at max. 80% relative humidity, non-condensing
<i>Storage</i>	+5 to +45 °C at max. 80% relative humidity, non-condensing
<i>Altitude / Pressure range</i>	max. 2,000 m.a.s.l. sea level / min. 780 mbar
<i>Overvoltage category</i>	II
<i>Pollution degree</i>	2

6.5 Dimensions

<i>Width</i>	142 mm
<i>Height</i>	64 mm
<i>Depth</i>	230 mm
<i>Weight</i>	1920 g
<i>Material</i>	Steel sheet

7 Accessories

Up-to-date information on the scope of delivery and optional accessories for your product can be found on the Internet. You can download this information using the article number as follows:

Downloading the accessories list

- 1** Enter <https://www.metrohm.com/> into your Internet browser.
- 2** Enter the article number (e.g. **846**) into the search field.
The search result is displayed.
- 3** Click on the product.
Detailed information regarding the product is shown on various tabs.
- 4** On the **Included parts** tab, click on **Download the PDF**.
The PDF file with the accessories data is created.



NOTE

Once you have received your new product, we recommend downloading the accessories list from the Internet, printing it out and keeping it together with the manual for reference purposes.

Index

6.2151.000 controller cable	12
685 Dosimat plus	15
700 Dosino	15
800 Dosino	15
801 Stirrer	16
803 Ti Stand	16
804 Ti Stand	16
805 Dosimat	15

A

Ambient conditions	29
--------------------------	----

B

Balance	20
Barcode reader	
Connect	22

C

Computer	
Connect	12
Connect	
Balance	20
Barcode reader	22
Computer	12
Connect to power grid	11
Dosing device	15
MSB devices	14
PC keyboard	21
Printer	19
Remote Box	17
Stirrer	16
Titration stand	16
USB hub	19
Connector	
Controller	9
MSB	2, 9
USB	2, 9

D

Device software	
Update	2

Dosing device	
Connect	15
Driver software	
Install	12

E

Electrostatic charge	6
----------------------------	---

F

Firmware	2
----------------	---

H

Humidity	29
----------------	----

I

Installation	
Driver software	12
Instrument description	2
Instrument type	9

K

Keyboard	
Connect	21

L

LED	
On	8

M

Mains connection	9
Metrohm Serial Bus MSB, see also	
"MSB"	14
MSB	
Connect devices	14
MSB connector	2

O

Operation	29
Overvoltage category	29

P

PC keyboard	
Connect	21
Pins	25
Power connection	11, 12
Printer	19

R

Remote	
Input	26
Interface	25
Output	26
Remote Box	
Connect	17
Pin assignment	25

S

Safety instructions	5
Sea level	29
Serial number	9
Service	5
Stacking frame	8, 10
Stirrer	
Connect	16
Stirring rate	27
Storage	29
Supply voltage	5

T

Temperature	29
Titration stand	
Connect	16

U

Update	
Device software	2
USB connector	2
USB hub	
Connect	19