



CH-9101 Herisau/Switzerland

E-Mail info@metrohm.com

Internet www.metrohm.com

798 MPT Titrino

Program version 5.798.0010

Instructions for Use

Table of contents

1 Introduction	1
1.1 Instrument description	2
1.2 Controls and parts	2
2 Manual operation.....	4
2.1 Keypad.....	4
2.2 Principle of data input.....	5
2.3 Text input	6
2.4 Configuration, key <CONFIG>	7
2.5 Selection of the mode, key <MODE>	13
2.6 Parameters, key <PARAM>.....	14
2.6.1 Parameters for DET and MET	14
2.6.2 Parameters for SET	24
2.6.3 Parameters for MEAS.....	33
2.6.4 Parameters for CAL.....	35
2.6.5 Parameters for TIP	37
2.7 Result calculations.....	38
2.8 Statistics calculation	41
2.9 Common variables.....	43
2.10 Data output	44
2.10.1 Reports for the output at the end of a determination.....	44
2.10.2 Display of the titration curve.....	47
2.11 User name, key <USER>	48
2.12 TIP, Titration procedure.....	49
2.13 Method memory, keys <USER METH> and <CARD>	53
2.13.1 Key <USER METH>	53
2.13.2 Key <CARD>	55
2.14 Calibration data, key <CAL.DATA>	58
2.15 Current sample data, key <SMPL DATA>	59
2.16 Silo memory for sample data.....	60
2.17 Storing determination results and silo calculations	63
2.17.1 Storing determination results	63
2.17.2 Silo calculations	64
3 Operation via RS232 Interface (green part).....	67
3.1 General rules.....	67
3.1.1 Call up of objects	68
3.1.2 Triggers	69
3.1.3 Status messages	70
3.1.4 Error messages.....	73
3.2 Remote control commands	77
3.2.1 Overview.....	77
3.2.2 Description of the remote control commands	97
3.3 Properties of the RS 232 Interface	126
3.3.1 Handshake.....	126
3.3.2 Pin Assignment	129
3.3.3 What can you do if the data transfer does not work?	131

4 Error messages, Troubleshooting	133
4.1 Error and special messages.....	133
4.2 Diagnosis.....	138
4.2.1 General	138
4.2.2 Procedure	138
4.2.3 Equipement required:	139
4.2.4 Diagnosis steps	139
4.3 Initialize RAM	149
4.4 Releasing a locked spindle with inserted Exchange Unit.....	150
5 Preparations	151
5.1 Setting up and connecting the instruments	152
5.1.5 Connection of a computer	155
5.1.6 Connection of a Remote Box.....	156
5.2 Connection of electrodes, preparing titration vessel.....	159
6 Appendix	162
6.1 Technical specifications	162
6.2 Pin assignment of the "Remote" socket.....	165
6.2.1 Lines of the "Remote" socket during the titration.....	167
6.2.2 Possible configurations of the activate pulse in SET and CAL.....	168
6.3 Titrino validation.....	169
6.3.1 Electronic tests	169
6.3.2 Wet tests	169
6.3.3 Maintenance and adjustment of the Titrino	169
6.4 Warranty and conformity	170
6.4.1 Warranty.....	170
6.4.2 EU Declaration of conformity.....	171
6.4.3 Certificate of Conformity and System Validation	172
6.5 Scope of delivery and ordering designations.....	173
Index.....	176

1 Introduction

1.1 Instrument description

The 798 MPT Titrino is an all-purpose titrator with LCD graphical display. Titration curves can be observed in real-time.

Titration modes of the 798 MPT Titrino are constant or – depending on the titration curve – variable dosing of the titration reagent and Endpoint-Titration.

The operator is almost free to define his titrations. All operating modes of the Titrino can be combined to perform extensive analytical sequences. The 798 MPT Titrino provides the opportunity to store, transfer and upload applications and results via memory card.

Data exchange with a PC is possible with the Metrodata VESUV Software. With Metrodata TiNet Software complete remote control, data acquisition and evaluation via PC is enabled.





1.2 Controls and parts

Front view of instrument:

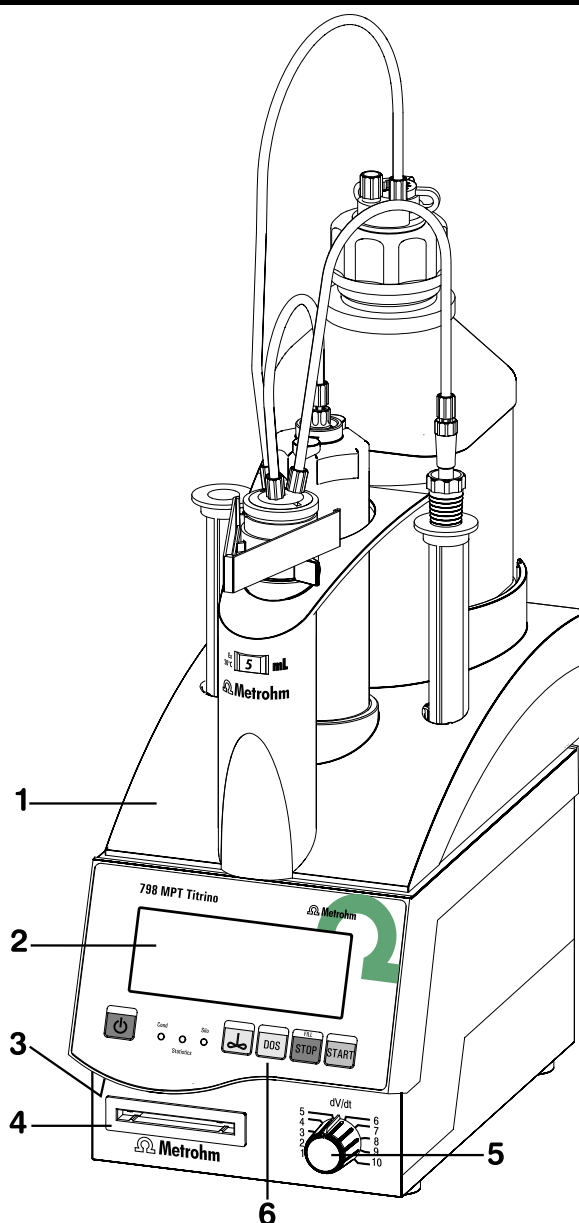
- 1 Exchange Unit
- 2 Display
- 3 Setting of display contrast
- 4 Opening for the memory card
- 5 Controls the dosing rate during manual dosing with <DOS> and subsequent filling
- 6 Control keys and indicator lamps on the Titrino



Key <  >	Power switch
Key <  >	Switching stirrer ON/OFF
Key <DOS>	Dosing key. Dispensing is performed as long as <DOS> is being pressed. Used e.g. to prepare the Exchange Unit. The dispensing rate can be set with potentiometer (5).
Key <STOP/FILL>	- Stops procedures, e.g. titrations, conditioning. - Filling after manual dosing with <DOS>.
Key <START>	Starts procedures, e.g. titrations, conditioning. Identical with key <START> of the separate keypad.
Indicator lamps:	
"COND."	Lamp flashes when conditioning is performed and the titration vessel is still wet. It is on if conditioning is ok.
"STATISTICS"	Lamp is on when the "statistics" function (calculation of mean and standard deviation) is on.
"SILO"	Lamp is on when silo memory (for sample data) is on.

Rear view of instrument:

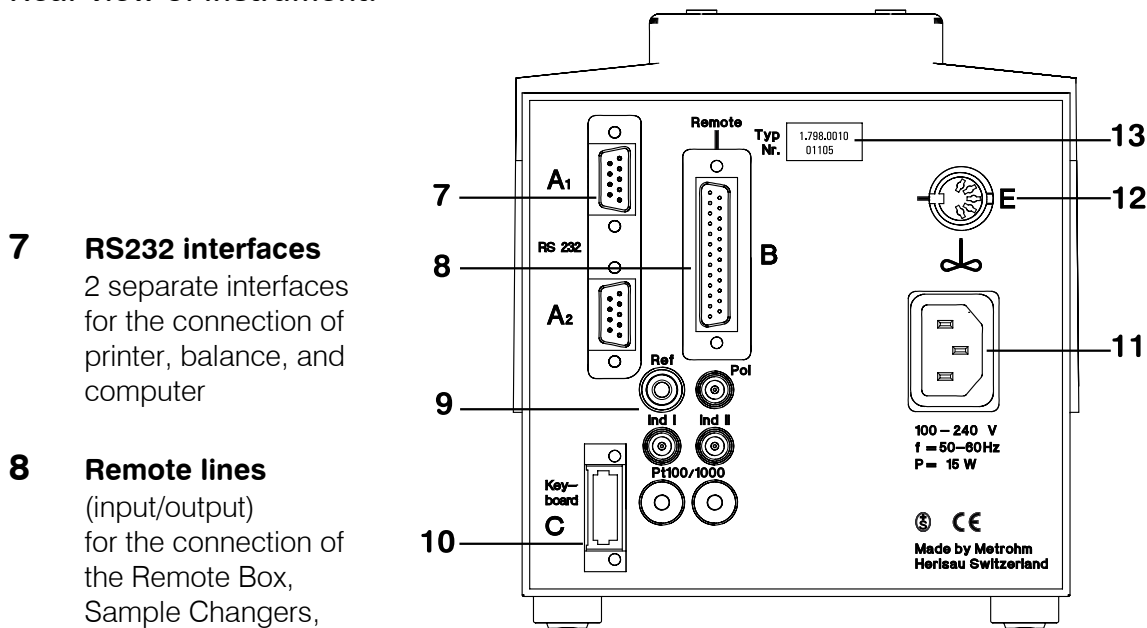

7 RS232 interfaces
2 separate interfaces for the connection of printer, balance, and computer

8 Remote lines
(input/output) for the connection of the Remote Box, Sample Changers, robots etc.

9 Connection of electrodes and temperature sensor

- 2 high-impedance measuring inputs for pH and U measurements. They can either be used separately or for differential potentiometry, see page 159. Important: If you work with both measuring inputs in the same vessel, the same reference electrode must be used.
- 1 measuring input for polarized electrodes, e.g. KF electrode
- 1 measuring input for PT100 or Pt1000 temperature sensor

10 Connection for separate keypad

11 Connection for power cable
With power supplies where the voltage is subject to severe HF disturbances, the Titrino should be operated via an additional power filter, e.g. Metrohm 615 model.

12 Connection for stirrer
728 Magnetic Stirrer, 802 Rod Stirrer, 703 or 727 Ti Stand
Supply voltage: 10 VDC ($I \leq 200 \text{ mA}$)

13 Rating plate
with fabrication, series and instrument number

2 Manual operation

2.1 Keypad

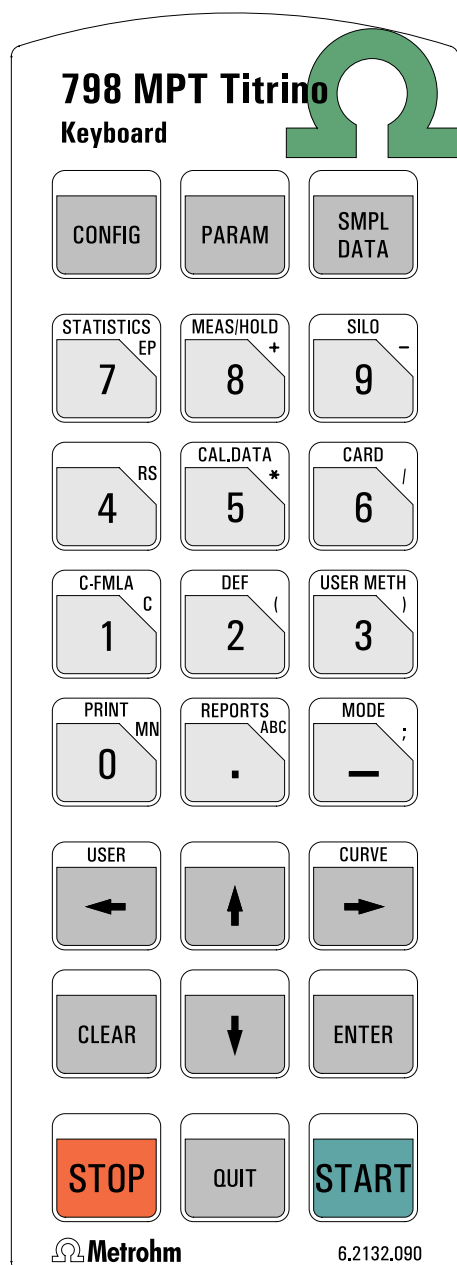

CONFIG	Configuration.
PARAM	Parameters.
SMPL DATA	Sample data.
STATISTICS	ON/OFF switching of statistics calculations of consecutive determination, see page 41.
MEAS/HOLD	ON/OFF switching of measurements between titrations and hold during titrations.
SILO	ON/OFF switching of silo memory for sample data, see page 60.
CAL.DATA	Calibration data, see page 58.
CARD	Management of memory card, see page 55.
C-FMLA	Calculation values, see page 40.
DEF	Formulas, data output, sequence for TIP, see page 38ff.
USER METH	Management of internal method memory, see page 53.
PRINT	Printing of reports, see page 45.
REPORTS	Result output.
MODE	Mode selection, see page 13.
USER	User name, see page 48.
CURVE	Switching result/curve display.
←, →	Selection of special values (dialog marked with ":")
↑, ↓	Cursor key for navigation.
CLEAR	Clears values, set special values.
ENTER	Stores values.
STOP	Stops methods.
QUIT	Quits inquiries, waiting times, printing.
START	Starts methods.

The third functions (inscriptions in the triangle) on the keys of the keypad are used for formula entry, see page 38.

2.2 Principle of data input

```

configuration
>monitoring
>peripheral units
>auxiliaries
>RS232 settings COM1
>RS232 settings COM2
>common variables
    
```

```

configuration
>peripheral units
  send to COM1:      IBM
  send to COM2:      IBM
  man.reports to COM: 1
  balance:           Sartorius
  stirrer control:   OFF
  remote box:        OFF
    
```

```

configuration
>monitoring
>peripheral units
>auxiliaries
>RS232 settings COM1
>RS232 settings COM2
>common variables
    
```

- If you press a key you will find a group of inquiries in the display.
Example key <CONFIG>:
In the first line you see where you are: You pressed key <CONFIG> and you are now in the inquiries "configuration".
- The cursor is inverted. In our example the cursor is on the inquiry ">monitoring". You can move the cursor up and down with keys <↑> and <↓>.
- If a dialog text is marked with ">", it contains a group of inquiries itself. You go to this group pressing <ENTER>.
Example inquiries of "peripheral units":
The first two lines indicate again where you are. Then you find the inquiries.
If a dialog text of an inquiry is marked with ":", you can select a value with keys <←> and <→> (forward/backward).
- A value is stored with <ENTER> and the cursor moves to the next inquiry.
- With key <QUIT> you move one level up, in our example you go back to ">peripheral units".
If you press <QUIT> once more you quit the inquiries in "configuration" altogether.
- If you can scroll, ↓ or ↑ appear in the right lower or upper corner of the display.

2.3 Text input

Example storing a method:

```
user methods
>store method
  method name:  ****
```

<CLEAR>

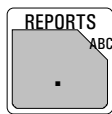

```
user methods
>store method:
  method name:
  ABCDEFGHIJKLMNOPQRSTUVWXYZ
  abcdefghijklmnopqrstuvwxyz
  µ°!"#$%&'()*+,-./ 0123456789
```

<QUIT>

```
user methods
>store method
  method name:  Text
```

<ENTER>

- Press key <USER METH>. Place the cursor to ">store method" and press <ENTER>. The name of the method which is currently in the working memory is displayed.
- Delete this name with <CLEAR>.
- Open the "text writing mode" with key <ABC>. You can now select the desired character by means of the cursor keys, then confirm this character. Select the next character... When you confirmed the last character, i.e. your name is complete, you quit the text writing mode with <QUIT>. Confirm now the name with <ENTER>.
- During text input you can correct typing errors with <CLEAR>: <CLEAR> deletes the characters one by one.
- If you wish to modify an existing name (e.g. if you have names like Text 1, Text 2, Text 3), do not delete the existing name before you start the text input mode. Proceed then as follows:
 1. Press <USER METH>, place the cursor to ">store method" and press <ENTER>.
 2. Open the text writing mode directly: Press key <ABC>.
 3. <CLEAR> now deletes the characters one by one or you can add additional characters.
 4. If your text is complete, leave the text writing mode with <QUIT> and confirm the text with <ENTER>.

2.4 Configuration, key <CONFIG>

<div style="text-align: center; border: 1px solid black; width: 60px; margin: 0 auto; padding: 5px;">CONFIG</div> <pre style="background-color: #f0f0f0; padding: 5px; border: 1px solid black;"> configuration >monitoring >peripheral units >auxiliaries >RS232 settings COM1 >RS232 settings COM2 >common variables </pre>	<p>Key <CONFIG> serves to enter device specific data. The set values apply to all modes.</p> <p>monitoring: Monitoring of instrument validation, pH calibration, service interval and printout of diagnostic report.</p> <p>peripheral units: Selection of printer, balance, stirrer control and COM for manual report output.</p> <p>auxiliaries: e.g. setting of dialog language, date time, type of result display.</p> <p>RS232 settings COM1 and 2: RS parameters for the COM's.</p> <p>common variables: Values of common variables.</p> <p>The display texts of the Titrino are shown to the left. The values are the default values.</p>
<pre style="background-color: #f0f0f0; padding: 5px; border: 1px solid black;"> >monitoring validation: OFF time interval 365 d time counter 0 d calibration: OFF meas.input: 1 time interval 7 d time counter 0 d </pre>	<p>Monitoring functions</p> <p><i>Monitoring the validation interval (ON, OFF)</i> Monitoring is carried out at the end of the titrations and when the Titrino is switched on. If the monitoring responds the message "validate instrument" appears. The message vanishes with <CLEAR>. At the same time the counter is reset to zero.</p> <p>If "on" has been set: <i>Time interval for validation (1...9999 d)</i> see also page 169.</p> <p><i>Time counter (0...9999 d)</i> Counts the number of days since the last time the counter was reset.</p> <p><i>Monitoring the pH calibration interval (ON, OFF)</i> Monitoring is carried out at the end of the titrations and when the Titrino is switched on if the measuring input has a current calibration date. If the monitoring responds the message "calibrate electrode" appears. The counter will be reset to zero on the next pH calibration of this input.</p> <p>If "on" has been set: <i>Measuring input (1, 2, diff.)</i> <i>Time interval for validation (1...9999 d)</i> <i>Time counter (0...9999 d)</i> Counts the number of days since the last time the counter was reset.</p>

service:	OFF	<p><i>Monitoring the service interval (ON, OFF)</i></p> <p>Monitoring is carried out after the Titrino has been switched on. If the monitoring responds the message "Service is due" appears. The message vanishes with <CLEAR>.</p>
next service	YYYY-MM-DD	<p>If "on" has been set: <i>Date of next service (YYYY-MM-DD)</i></p>
system test report:	OFF	<p><i>System test report printout (ON, OFF)</i></p> <p>With "on" the report of the system test is printed out after the Titrino has been switched on, see also page 169.</p>
>peripheral units		Settings for peripheral units
send to COM1:	IBM	<p><i>Selection of printer (Epson, Seiko, Citizen, HP, IBM) at the Titrino COM1</i></p>
send to COM2:	IBM	<p>"Epson", for Epson "Seiko", e.g. for DPU-414 "Citizen", e.g. for iDP 562 RS, Custom DP40-S4N "HP" e.g. for Desk Jet types. Place curves always at the beginning of a page as you cannot have them over 2 pages. "IBM" for all printers with IBM character set Table 437 and IBM graphics, as well as for the data transmission to a computer or a data system.</p>
man.reports to COM:	1	<p><i>COM of Titrino for the output of manually triggered reports (1, 2, 1&2)</i></p> <p>Manually triggered reports e.g. with <PRINT> Exception <PRINT><REPORTS>: These reports are outputted on the COM as defined in the method.</p>
balance:	Sartorius	<p><i>Selection of balance (Sartorius, Mettler, Mettler AT, AND, Precisa)</i></p> <p>Sartorius: Models MP8, MC1 Mettler: Models AM, PM, AX, MX, UMX and balances with 011, 012, or 016 interface Mettler AT: Model AT AND: Models ER-60, 120, 180, 182, FR-200, 300 and FX-200, 300, 320 Precisa: Models with RS232C interface</p>
stirrer control:	OFF	<p><i>Automatic switching ON/OFF of the stirrer in the titration sequence (ON, OFF)</i></p> <p>If stirrer control is ON, the stirrer will be switched on at the beginning and switched OFF at the end of a determination. For SET with conditioning the stirrer will be switched off in the inactive state. In the modes MEAS, CAL, and TIP the stirrer is not switched automatically. For stirrer control the red switch on the stirrer unit must be ON.</p>

<p>remote box: OFF</p> <p>keyboard: US</p> <p>barcode: input</p>	<p><i>Connection of a remote box (on ,OFF)</i> To the remote socket for PC keyboard and barcode reader, see page 156. If "on" has been set:</p> <p><i>Type of PC keyboard (US, German, French, Spanish, Swiss.)</i> The PC keyboard is used as an input aid, see page 157.</p> <p><i>Target for barcode reader (input, method, id1, id2, id3, smpl size)</i> The barcode reader is used as an input aid, see page 156.</p> <p>Input: The barcode string goes to the entry field in which the cursor is currently located.</p> <p>Method: The barcode string goes to the entry field "Methods" in the silo memory.</p> <p>Id1: The barcode string goes to the entry field "Id1". (Similar for Id2 and Id3.)</p> <p>Smpl size: The barcode string goes to the entry field "smpl size".</p>
<p>>auxiliaries</p> <p>dialog: english</p> <p>date 2001-10-19</p> <p>time 08:13</p> <p>run number 0</p> <p>auto start OFF</p> <p>start delay 0 s</p> <p>result display: bold</p>	<p>General settings</p> <p><i>Selection of dialog language (english, deutsch, francais, español, italiano, portugese, svenska)</i></p> <p><i>Current date (YYYY-MM-DD)</i> Format: Year-month-day, entry with leading zeros.</p> <p><i>Current time (HH-MM)</i> Format: Hours-minutes, entry with leading zeros.</p> <p><i>Current run number for result output (0...9999)</i> The sample number is set to 0 when the instrument is switched on and incremented on every determination.</p> <p><i>Automatic starts of titrations. (1...9999, OFF)</i> Number of automatic starts ("number of samples"). Used for instrument interconnections in which the external instrument does not initiate a start. Not advisable in connections with Sample Changers.</p> <p><i>Start delay (0...999 999 s)</i> Delay time after start of methods. Abort start delay time with <QUIT>.</p> <p><i>Type of result display at the end of the determination (bold, standard)</i> bold: The calculated results are displayed in bold characters. standard: Displays the whole information, e.g. results, endpoints, messages etc.</p>

dev.label.		<i>Individual identification of devices (up to 8 ASCII characters) Will be printed in the result report, see page 45.</i>
program	798.0010	<i>Display of program version</i>
>RS232 settings COM1		Settings of RS232 interface see also page 126. Identical for COM2.
baud rate:	9600	<i>Baud rate (300, 600, 1200, 2400, 4800, 9600, 19200, 38400, 57600, 115200)</i>
data bit:	8	<i>Data bit (7, 8)</i>
stop bit:	1	<i>Stop bit (1, 2)</i>
parity:	none	<i>Parity (even, odd, none)</i>
handshake:	HWs	<i>Handshake (HWs, SWline, SWchar, none) see page 126.</i>
>common variables		Values of the common variables
C30 etc.	0.0	<i>Common variables C30...C39 (0.. ± 999 999) The values of all common variables are displayed. For creating of common variables see page 43.</i>

Settings with key <CONFIG> and power ON

Proceed as follows:

1. Switch the Titrino OFF.
2. Press <CONFIG> and keep it pressed during switching the Titrino ON.

The display shows the following:

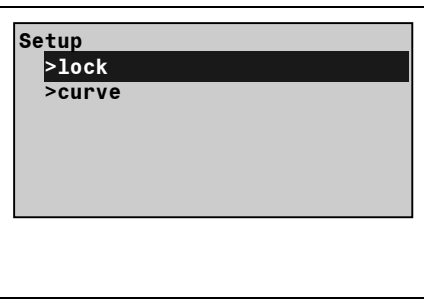
	<p>lock: Locking keys <CONFIG>, <PARAM> and <SMPL DATA>, and the functions "recall method", "store method" and "delete method" of the internal method memory in the Titrino.</p> <p>curve: Changes the appearance of the curve printout.</p>
<pre> >lock <configuration>: OFF <parameters>: OFF <smpl data>: OFF recall method: OFF store method: OFF delete method: OFF </pre>	<p>lock "ON" means that the corresponding function is not accessible anymore.</p> <p>The corresponding key is locked.</p> <p>The corresponding function in the internal method memory of the Titrino is locked.</p>

>curve		<p>curve</p> <p>The settings are valid for COM1 and COM2. If you change the printer type, the following settings are initialized according to the printer.</p>																		
grid:	ON	<i>Grid drawing (ON, OFF)</i>																		
frame:	ON	<i>Frame drawing (ON, OFF)</i>																		
scaling:	Full	<p><i>Type of scaling (Full, Auto)</i></p> <p>Full: The scaling goes from the greatest to the smallest value. auto: The scaling from tick to tick, e.g. the smallest/greatest values lie in between the first/Last tick.</p>																		
width	0.75	<p><i>Width (0.2...1.00)</i></p> <p>1 is greatest width. If you set 1 you may loose the label at the right margin.</p>																		
length	0.1	<p><i>Length (0.01...1.00)</i></p> <p><i>Volume axis</i></p> <p>Curve length per cylinder volume</p> <table> <tr><td>0.01</td><td>100 cm</td></tr> <tr><td>0.1</td><td>10 cm</td></tr> <tr><td>0.5</td><td>2 cm</td></tr> <tr><td>1</td><td>1 cm</td></tr> </table> <p><i>Time axis:</i></p> <table> <tr><td></td><td>Curve length</td></tr> <tr><td>0.01</td><td>100 cm</td></tr> <tr><td>0.1</td><td>10 cm</td></tr> <tr><td>0.5</td><td>2 cm</td></tr> <tr><td>1</td><td>1 cm</td></tr> </table>	0.01	100 cm	0.1	10 cm	0.5	2 cm	1	1 cm		Curve length	0.01	100 cm	0.1	10 cm	0.5	2 cm	1	1 cm
0.01	100 cm																			
0.1	10 cm																			
0.5	2 cm																			
1	1 cm																			
	Curve length																			
0.01	100 cm																			
0.1	10 cm																			
0.5	2 cm																			
1	1 cm																			

2.5 Selection of the mode, key <MODE>

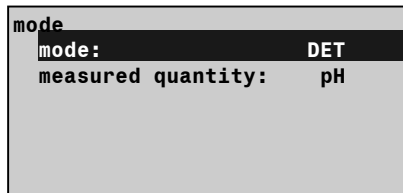
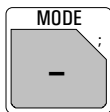

Press key <MODE> until the desired mode is displayed and confirm with <ENTER>. Select the measured quantity pH, U, Ipol, Upol, (T) with <←> or <→> and confirm it also with <enter>.

The following modes can be selected:

- DET: **D**ynamic **E**quivalence-point **T**itration
- MET: **M**onotonic **E**quivalence-point **T**itration
- SET: **S**et **E**ndpoint **T**itration.
- CAL: pH **C**alibration.
- MEAS: **M**easuring.
- TIP: **T**itration **P**rocedure. Linking of various commands and methods to a titration procedure.

These standard modes are equipped with a set of standard parameters. They only need few settings in order to be ready to work.

TIP is an empty "shell". The TIP sequence has to be defined with <DEF>, see page 49.

You will find a survey of the modes in the short Instructions for use.

2.6 Parameters, key <PARAM>

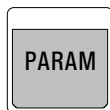

The key <PARAM> is used for the entry of values that determine the modes. Values marked with "cond." are accessible during the conditioning in the SET mode. "**titr." means that these values can be changed during the titration. They influence the ongoing determination. Other values can only be changed in the inactive state.

The display texts of the Titrino are shown to the left. The values are the default values.

2.6.1 Parameters for DET and MET

```
parameters
>titration parameters
>stop conditions
>statistics
>evaluation
>preselections
```

titration parameters

determine the course of the titration and measured value acquisition.

stop conditions:

Parameters for the automatic termination of the titration.

statistics:

Calculation of mean values and standard deviation, see page 41.

evaluation:

Parameters for the evaluation of EP's, fix EP's, and pK/HNP.

preselections:

ON/OFF of various auxiliary functions such as automatic requests after the start and activate pulse.

```
>titration parameters
```

```
meas.pt.density    4
DET
```

```
min.incr.         10.0 µl
DET
```

```
V step            0.10 ml
MET
```

General titration parameters

Measuring point density (0...9)

0 means highest density, 9 lowest. Selection of the meas.pt.density, see page 20.

Minimum increment (0...999.9 µL)

The increment is dispensed at the beginning of the titration and in the region of the equivalence point.

Size of volume increment (0...9.999 mL)

Dosing step. Small volume increments are needed to determine blank values or to assure accuracy with highly unsymmetrical curves. Selection of size of the increment, see page 20.

dos.rate **titr.	max. ml/min	<p>Dosing rate for volume increments (0.01...150 mL/min, max.)</p> <p><CLEAR> sets "max".</p> <p>The maximum rate depends on the Exchange Unit:</p> <table border="1"> <thead> <tr> <th>Exchange Unit</th> <th>max.</th> </tr> </thead> <tbody> <tr> <td>5 mL</td> <td>15 mL/min</td> </tr> <tr> <td>10 mL</td> <td>30 mL/min</td> </tr> <tr> <td>20 mL</td> <td>60 mL/min</td> </tr> <tr> <td>50 mL</td> <td>150 mL/min</td> </tr> </tbody> </table>	Exchange Unit	max.	5 mL	15 mL/min	10 mL	30 mL/min	20 mL	60 mL/min	50 mL	150 mL/min
Exchange Unit	max.											
5 mL	15 mL/min											
10 mL	30 mL/min											
20 mL	60 mL/min											
50 mL	150 mL/min											
signal drift **titr.	50 mV/min	<p>Drift criterion for measured value acquisition. (input range depends on the measured quantity:</p> <p>pH, U, I_{pol}: 0.5...999 mV/min, OFF</p> <p>U_{pol}: 0.05...99.9 µA/min, OFF)</p> <p><CLEAR> sets "OFF".</p> <p>This type of measured value acquisition is often called an equilibrium titration.</p> <p>"OFF" means that the measured value is acquired after an equilibration time. This may be useful for slow titration reactions or when the response of the electrode assembly is slow.</p>										
equilibr.time **titr.	26 s	<p>Waiting time for measured value acquisition. (0...9999 s, OFF)</p> <p><CLEAR> sets "OFF".</p> <p>If no new equilibration time has been entered, the Titrino calculates an equilibration time appropriate to the drift, see page 19. The measured value is acquired as soon as the first criterion (drift or time) has been met.</p>										
start V:	OFF	<p>Type of start volume (OFF, abs., rel.)</p> <p>"OFF": start volume switched off</p> <p>"abs": absolute start volume in mL</p> <p>"rel.": relative start volume to sample size.</p>										
start V	0.0 ml	<p>If "abs." is set:</p> <p>Absolute start volume (0...999.99 mL)</p>										
factor	0	<p>If "rel." is set:</p> <p>Factor for relative start volume (0...±999 999).</p> <p>Calculated as: start V (in mL) = factor * sample size</p>										
dos.rate **titr.	max. ml/min	<p>Dosing rate for start volume (0.01...150 mL/min, max.)</p> <p><CLEAR> sets "max".</p> <p>Maximum rate depends on the Exchange Unit:</p> <table border="1"> <thead> <tr> <th>Exchange Unit</th> <th>max.</th> </tr> </thead> <tbody> <tr> <td>5 mL</td> <td>15 mL/min</td> </tr> <tr> <td>10 mL</td> <td>30 mL/min</td> </tr> <tr> <td>20 mL</td> <td>60 mL/min</td> </tr> <tr> <td>50 mL</td> <td>150 mL/min</td> </tr> </tbody> </table>	Exchange Unit	max.	5 mL	15 mL/min	10 mL	30 mL/min	20 mL	60 mL/min	50 mL	150 mL/min
Exchange Unit	max.											
5 mL	15 mL/min											
10 mL	30 mL/min											
20 mL	60 mL/min											
50 mL	150 mL/min											

pause **titr.	0 s	<p><i>Waiting time (0...999 999 s)</i></p> <p>Waiting time, e.g. for equilibration of the electrode after the start or reaction time after dosing of start volume. The pause can be aborted with <QUIT>.</p>
meas.input:	1	<p><i>Measuring input for pH and U (1, 2, diff.)</i></p> <p>Request for measuring input for pH and U. Measuring input 1 or 2 or differential amplifier; connection of electrodes, see page 159.</p> <p>With polarized electrodes, instead of the measuring input the</p>
I(pol)	1 μA	<p><i>polarization current (-127...127 μA)</i></p> <p>or the</p>
U(pol)	400 mV	<p><i>polarization voltage (-1270...1270 mV, in steps of 10 mV)</i></p> <p>is inquired.</p>
electrode test:	OFF	<p><i>Electrode test (OFF, ON)</i></p> <p>Test for polarized electrodes. Performed on changeover from the inactive standby state to a measurement. "OFF" means that the test is not performed.</p>
temperature	25.0 $^{\circ}$C	<p><i>Titration temperature (-170.0...500.0 $^{\circ}$C)</i></p> <p>The temperature is continuously measured if a T sensor is connected. This parameter is used for temperature compensation in pH titrations.</p>
>stop conditions		<p>Stop conditions for the titration</p> <p>If several stop conditions have been set, the criterion which is met first applies.</p>
stop V: **titr.	abs.	<p><i>Type of stop volume (abs., rel., OFF)</i></p> <p>"abs.": absolute stop volume in mL. "rel.": relative stop volume to sample size. "OFF": stop volume switched off. Stop volume is not monitored.</p>
stop V **titr.	99.99 mL	<p>If "abs." is set: <i>Absolute stop volume (0...9999.99 mL)</i></p>
factor **titr.	999999	<p>If "rel." is set: <i>Factor for relative stop volume (0...\pm999 999)</i></p> <p>Calculated as: Stop V (in mL) = factor * sample size</p>
stop pH **titr.	OFF	<p><i>Stop at measured value (input range dependent on measured variable:</i></p> <p>pH: 0... \pm 20.00, OFF U, Ipol: 0... \pm 2000 mV, OFF Upol: 0... \pm 200.0 μA, OFF) <CLEAR> sets "OFF". "OFF" means that the criterion is not monitored.</p>

<p>stop EP **titr.</p>	<p>9</p>	<p>Stop after a number of EP's have been found (1...9, OFF) <CLEAR> sets "OFF". "OFF" means that the criterion is not monitored.</p>
<p>filling rate max. ml/min **titr.</p>		<p>Filling rate (0.01...150 mL/min, max.) <CLEAR> sets "max." The maximum rate depends on the Exchange Unit: Exchange Unit max. 5 mL 15 mL/min 10 mL 30 mL/min 20 mL 60 mL/min 50 mL 150 mL/min</p>
<p>>evaluation</p>		<p>EP evaluation/recognition See page 20 ff.</p>
<p>EPC</p>	<p>5</p>	<p>Equivalence point criterion (input range depends on mode. For DET: 0...200 For MET: pH: 0.10...9.99 U, Ipol: 1...999 mV Upol: 0.1...99.9 µA) Threshold for the size of the jump, see page 22.</p>
<p>EP recognition:</p>	<p>all</p>	<p>Recognition of EP's which fulfill the EP criterion. (all, greatest, last, window, OFF) Selection of equivalence point recognition: "all": All equivalence points are recognized. "greatest": Only the greatest (steepest) equivalence point is recognized. "last": Only the last equivalence point is recognized. "window": Only EP's in specified windows are recognized. "OFF": Evaluation switched off. If "window" is selected, lower and upper limits of windows are inquired.</p>
<p>low lim.1 pH</p>	<p>-20.00</p>	<p>Lower limit of window 1 and upper limit of window 1 (Input ranges for both inquiries depend on the measured quantity): pH: 0...±20.00, OFF U, Ipol: 0...±2000 mV, OFF Upol: 0...±200.0 µA, OFF) <CLEAR> sets "OFF". Only equivalence points are recognized which lie within the set lower and upper limits. The equivalence point numbering is defined with the windows, see page 22. Window inquiries continue until the lower limit is set to "OFF". Up to 9 possible windows. Always set both limits to ≠ OFF for a valid window.</p>
<p>up lim.1 pH</p>	<p>20.00</p>	

fix EP1 at pH	OFF	<p><i>Interpolation of volumes at fixed times (input range depends on the measured quantity:</i> <i>pH: 0...±20.00, OFF</i> <i>U, Ipol: 0...±2000 mV, OFF</i> <i>Upol: 0...±200.0 µA, OFF)</i> <CLEAR> sets "OFF". If a fix end point has been set, the volume value for the input measured value is interpolated from the curve, see also page 23. The volume values are available as C5X. Fix EP's are inquired until "OFF" is set. Up to 9 fix EP's.</p>
pK/HNP:	OFF	<p><i>Evaluation of pK or HNP (ON, OFF)</i> pK evaluation in case of pH titrations and half neutralization potential for U, see page 23.</p>
>preselections		Preselections for the sequence
req.ident:	OFF	<p><i>Request of identifications after start of titration. (id1, id1&2, all, OFF)</i> After start, sample identifications can be inquired automatically: Only id1, id1 & id2, all three id's or no inquiries.</p>
req.smp1 size:	OFF	<p><i>Request of sample size after start of titration (value, unit, all, OFF)</i> "all" requests the value, then the unit.</p>
limit smp1 size:	OFF	<p><i>Limiting value check for sample size (ON, OFF)</i> With "on" the error message "sample size out." appears if the entry is outside the set limits. The limiting values are shown in the display window. The absolute value of the limit is checked during sample size input and during the calculation of the results. If "on" has been set:</p>
low lim.	0.0	<i>Lower limit for sample size (0.0...999 999)</i>
up lim.	999999	<i>Upper limit for sample size (0.0...999 999)</i>
activate pulse:	OFF	<p><i>Pulse output on I/O line "activate" (L6, pin 1) of the remote socket (ON, OFF)</i> see page 167.</p>

Titration sequence of DET and MET

<START>	
(Activate pulse) (Stirrer ON)	After the start, the activate pulse is outputted and the stirrer switched on.
(Start delay)	The start delay time is waited off.
(Request ident.) (Request smpl size)	The sample identifications and the sample size are requested.
(Start conditions)	The start volume is dispensed (no meas.value acquisition) and the pause is waited off.
Titration: Dispense increments Acquire meas.values	During the titration the volume increments are dispensed and after each increment a measured value is acquired. Meas.values are either acquired drift controlled ("equilibrium titration") or a after a fixed waiting time. If you have not intentionally changed the equilibration time, it is calculated according to the formula: $\text{equilibr.time (in s)} = \frac{150}{\sqrt{\text{Drift} + 0.01}} + 5$
Stop conditions	The titration is terminated according to the first criterion which is met.
(Stirrer OFF)	The stirrer is switched off.
Calculations	Evaluations and calculations are carried out.
Data output	Data are outputted.

Reagent feeding and EP evaluation of DET

The reagent feeding of DET is similar to the controlling, a human being would apply in manually controlled titrations: Great volume increments are dosed far away from the EP, small increments in the region of the equivalence point.

The size of the volume increments dosed by the Titrino is determined by the following parameters:

meas.pt.density	<p>The measuring point density is entered as a relative value from 0...9. Input of a low number means small volume increments, i.e. a large measuring point density on the curve. A curve results which reproduces all fine details. "Fine details", however, also include signal noise, which can easily lead to unwanted equivalence points. A high number, i.e. low measuring density, on the other hand, allows a more rapid titration. The standard value of 4 is suitable for most cases.</p> <p>If you work with small cylinder volumes (1 or 2 mL), a small measuring point density may be advisable. In these cases you should also lower the drift for meas.value acquisition and set a higher EPC.</p>
min.incr.	<p>Defines the minimum possible increment. This minimum increment is dosed at the beginning of the titration and in the region of the equivalence point (for steep curves). Use low minimum increments only, if small volumes of titrant consumption are expected, e.g. in micro titrations; otherwise unwanted equivalence points may arise. The standard value of 10.0 μL is suitable for most cases.</p>
EPC	<p>The EP's are evaluated according to a special METROHM procedure which is so sensitive that even weak equivalence points are determined correctly.</p> <p>Equivalence Point Criteria. The <i>preset</i> EPC is compared to the <i>found</i> ERC (Equivalence point Recognition Criteria) for each evaluated equivalence point. The size of the ERC is displayed in the titration curve, see page 47. The ERC is the first derivative of the titration curve overlaid with a mathematical function so that small maxima become higher and great maxima smaller. EP's whose ERC is below the preset EPC will not be recognized. For most cases the standard value of 5 is suitable. The evaluation can be repeated at any time after the titration in a "dry run" with changed evaluation criteria. The old titration data are not deleted until a new titration is started.</p>

Reagent feeding and EP evaluation of MET

In monotonic titrations, the volume increment is constant over the whole titration curve.

<p>V step</p>	<p>Volume increment. A prerequisite for good accuracy is the correct size of the volume increments. A good value is given by V step = 1/20 V_{EP} (V_{EP} = volume of the EP). In any case, the increment size should always be between 1/10 V_{EP} and 1/100 V_{EP}; with steep jumps preferably in the region of 1/100 and with flat jumps preferably in the region of 1/10. The accuracy of the evaluation can not be increased by dispensing small increments as the changes in the measured value can then be of the same order of magnitude as the noise. This can produce "ghost EP's"!</p>
<p>EPC</p>	<p>The EP's are localized with an algorithm which is based on Fortuin and has been adapted by METROHM for numeric procedures. (METROHM Bulletin <u>2</u>, No. 10, 1971). Here, the greatest change in the measured value is sought (Δ_n). The exact equivalence point is determined with an interpolation factor, which depends on the delta values before and after Δ_n:</p> $V_{EP} = V_0 + \rho \Delta V$ <p> V_{EP}: EP volume V₀: Total dispensed volume before Δ_n ΔV: Volume increment ρ: Interpolation factor (Fortuin) </p> <p>Equivalence Point Criteria. The <i>preset</i> EPC is compared to the <i>found</i> ERC (Equivalence point Recognition Criteria) for each evaluated equivalence point. The size of the ERC is displayed in the titration curve, see page 47. ERC is the sum of the measured value changes before and after the break:</p> $ \Delta_{n-2} + \Delta_{n-1} + \Delta_n + \Delta_{n+1} + \Delta_{n+2} $ <p>(In certain cases there are only 3 or 1 summand). EP's whose ERC is below the preset EPC will not be recognized. For most titrations the standard value is suitable. The evaluation can be repeated at any time after the titration in a "dry run" with changed evaluation criteria. The old titration data are not deleted until a new titration is started.</p>

EP recognition criteria for DET and MET

The parameter "EP recognition" offers you a range of possibilities to ensure selection of the EP you are interested in: If the desired jump is very large, you can select the "greatest" jump (with DET the steepest jump will be evaluated). Thus you always obtain just one EP per titration (EP1).

If you wish to determine the sum of different components (e.g. acid or base numbers), the "last" jump can be the correct one.

And finally you can set a "window" for each expected EP.

EP windows

EP windows are used

- to suppress disturbing influences and EP's which are not needed.
- to increase the liability for the calculation of the results. The EP windows make an unequivocal assignment of the EP's possible: per window one EP is recognized; the numbering of EP's is defined by the windows so that even if EP's are missing, the calculations are still performed with the correctly assigned EP volumes.

An EP window defines the range in which an EP is expected. EP's outside these ranges are not recognized. Windows are defined on the measured value axis.

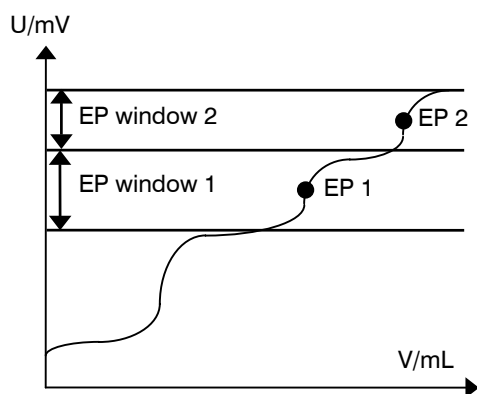

2 EP's are recognized. Their numbering is defined by the windows:
Window 1 \Rightarrow EP1
Window 2 \Rightarrow EP2

If more than 1 EP is expected, a window must be set for each EP.

Windows must not overlap. They may only touch each another.

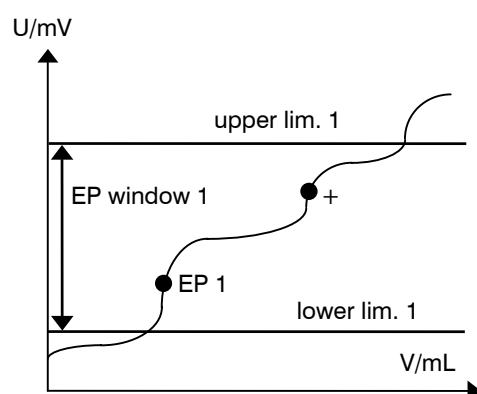

Rule: If there are more than 1 EP in a window, the first jump is recognized as EP1, the second is not recognized. EP1 is marked as EP1 + to indicate that more than one EP has been found in the window

Fix EP's

Fix EP's allow determination of the associated volume value for every inputted measured value on the titration curve. This function is useful for performing standard methods such as TAN/TBN determinations. For the evaluation of fix EP's, the pH calibration is advisable. The volume values of the fix EP's are available for the calculation as C5X:

Fix EP1 \Rightarrow C51

:

Fix EP9 \Rightarrow C59

Maximum 9 fix EP's are possible.

pK and HNP evaluation

The following relation (Henderson-Hasselbach), derived from the law of mass action, exists between the activities of a conjugate acid-base pair in aqueous solutions:

$$\text{pH} = \text{pK} + \log (a_{\text{B}}/a_{\text{A}})$$

When the activities $a_{\text{B}} = a_{\text{A}}$, then $\text{pH} = \text{pK}$ is valid. This value corresponds to the pH at the half neutralization point and can be taken from the titration curve. For pK determinations, a careful pH calibration is necessary.

The pK value determined is an approximate value owing to the fact that the ionic strength of the solution has not been taken into account. For more exact values, titrations must be performed with decreasing ionic strength and the results extrapolated to zero ionic strength.

The evaluation of pK's in aqueous solutions is limited to

pK > 3.5 due to the leveling effect of strong acids in aqueous solutions

pK < 10.5 because for weaker acids no inflection points can be found aqueous solutions.

pK evaluation for polybasic acids and for acid mixtures is also possible.

In non-aqueous solutions, the half neutralization potential (HNP) is often used instead of pK. The HNP is evaluated accordingly.

A start volume must be smaller than half of the equivalence point volume of the first EP.

The pK/HNP values are available for calculation as C6X.

Minimum/maximum evaluation

Volumes at minimum or maximum voltage values are extrapolated. These volumes are accessible as variables C49 and C48 resp. and can be used in formulas.

2.6.2 Parameters for SET

<pre> parameters >SET1 >SET2 >titration parameters >stop conditions >statistics >preselections </pre>	<p>SET1, SET2: Control parameters for EP1 and EP2.</p> <p>titration parameters are valid for the global titration sequence.</p> <p>stop conditions: Parameters for the termination of the titration.</p> <p>statistics: Calculation of mean values and standard deviation, see page 41.</p> <p>preselections: ON/OFF of various auxiliary functions such as automatic requests after the start and activate pulse.</p>										
<pre> >SET1 EP at pH OFF **titr. dynamics OFF **titr. max.rate 10.0 ml/min **titr. </pre>	<p>Control parameters for EP1 or EP2, resp.</p> <p><i>Preset EP1 (input range depends on the measured quantity:</i> <i>pH: 0...±20.00, OFF</i> <i>U, Ipol: 0...±2000 mV, OFF</i> <i>Upol: 0...±200.0 µA, OFF)</i> <CLEAR> sets "OFF". If EP1 is "OFF", no further inquiries under SET1 appear.</p> <p><i>Distance from EP where constant dosing should stop and controlling begins. (control range, input range depends on the measured quantity:</i> <i>pH: 0.01...20.00, OFF</i> <i>U, Ipol: 1...2000 mV, OFF</i> <i>Upol: 0.1...200.0 µA, OFF)</i> <CLEAR> sets "OFF". "OFF" means largest control range, i.e. low titration. Outside the control range, dispensing is performed continuously, see also page 30.</p> <p><i>Maximum dosing rate (0.01...150 mL/min, max.)</i> <CLEAR> sets "max.". This parameter determines primarily the addition rate outside the control range, see also page 30. The maximum rate depends on the Exchange Unit:</p> <table data-bbox="616 1653 1011 1809"> <tr> <td>Exchange Unit</td> <td>max.</td> </tr> <tr> <td>5 mL</td> <td>15 mL/min</td> </tr> <tr> <td>10 mL</td> <td>30 mL/min</td> </tr> <tr> <td>20 mL</td> <td>60 mL/min</td> </tr> <tr> <td>50 mL</td> <td>150 mL/min</td> </tr> </table>	Exchange Unit	max.	5 mL	15 mL/min	10 mL	30 mL/min	20 mL	60 mL/min	50 mL	150 mL/min
Exchange Unit	max.										
5 mL	15 mL/min										
10 mL	30 mL/min										
20 mL	60 mL/min										
50 mL	150 mL/min										

min.rate **titr.	25.0 $\mu\text{l}/\text{min}$	<i>Minimum dosing rate (0.01...999.9 $\mu\text{L}/\text{min}$)</i> This parameter determines the addition rate right at the start and the end of the titration, see also page 30. This parameter influences the titration speed and therefore its accuracy very strongly: A smaller min.rate results in a slower titration.
stop crit: **titr.	drift	<i>Type of stop criteria (drift, time)</i>
stop drift **titr.	20 $\mu\text{l}/\text{min}$	<i>Titration stops if EP is and stop drift is reached. (1...999 $\mu\text{L}/\text{min}$)</i>
t(delay) **titr.	10 s	<i>Titration stops if there is no dosing during t(delay). (0...999 s, INF)</i> <CLEAR> sets "INF" Switch off when the end point is reached and the set time after the last dispensing has elapsed. If "INF" is set, an inquiry regarding the stop time appears. If t(delay) is "INF"
stop time **titr.	OFF s	<i>Stop after a time (0...999 999 s, OFF)</i> <CLEAR> sets "OFF". Stop after the set time after the start of the titration. "OFF" means no stop, i.e. titration for an "infinitely" long time.
>titration parameters		General titration parameters
titr.direction:	auto	<i>Direction is set automatically (+, -, auto)</i> auto: The direction is set automatically by the Titrino (sign $[U_{\text{first}} - \text{EP}]$). +: Direction of higher pH, higher voltage (more "positive"), larger currents. - : Direction of lower pH, lower voltage, smaller currents. The titration direction is fixed if two EP's are set. In this case, an input for titration direction has no meaning.
pause 1 **titr.	0 s	<i>Pause 1 (0...999 999 s)</i> Waiting time before start volume, e.g. for equilibration of the electrode after the start. The waiting time can be aborted with <QUIT>.
start V: cond.	OFF	<i>Type of start volume (OFF, abs., rel.)</i> "OFF": start volume switched off "abs.": absolute start volume in mL "rel.": relative start volume to sample size.
start V cond.	0.0 mL	If "abs." is set: <i>Absolute start volume (0...999.99 mL)</i>
factor cond.	0	If "rel." is set: <i>Factor for relative start volume (0...\pm999 999).</i> Calculated as: start V (in mL) = factor * sample size

dos.rate **titr.	max. ml/min	<p><i>Dosing rate for start volume (0.01...150 mL/min, max.)</i> <CLEAR> sets "max." The maximum rate depends on the Exchange Unit:</p> <table border="1"> <thead> <tr> <th>Exchange Unit</th> <th>max.</th> </tr> </thead> <tbody> <tr> <td>5 mL</td> <td>15 mL/min</td> </tr> <tr> <td>10 mL</td> <td>30 mL/min</td> </tr> <tr> <td>20 mL</td> <td>60 mL/min</td> </tr> <tr> <td>50 mL</td> <td>150 mL/min</td> </tr> </tbody> </table>	Exchange Unit	max.	5 mL	15 mL/min	10 mL	30 mL/min	20 mL	60 mL/min	50 mL	150 mL/min
Exchange Unit	max.											
5 mL	15 mL/min											
10 mL	30 mL/min											
20 mL	60 mL/min											
50 mL	150 mL/min											
pause 2 **titr.	0 s	<p><i>Pause 2 (0...999 999 s)</i> Waiting time after start volume, e.g. reaction time after dosing of a start volume. The waiting time can be aborted with <QUIT>.</p>										
extr.time **titr.	0 s	<p><i>Extraction time (0...999 999 s)</i> During this time the titration is already running. It will be not stopped (also if the EP is already reached) before the extraction time is terminated. The extraction time can be aborted with <QUIT>.</p>										
meas.input:	1	<p><i>Measuring input (1, 2, diff.)</i> Inquiry only with measured quantities pH and U. Measuring input 1 or 2 or differential amplifier; connection of electrodes, see page 159.</p>										
I(pol)	1 μA	<p>With polarized electrodes, instead of the measuring input the <i>polarization current (-127...127 μA)</i> or the <i>polarization potential (-1270...1270 mV, in steps of 10 mV)</i> is inquired.</p>										
U(pol)	400 mV											
electrode test:	OFF	<p><i>Electrode test (OFF, ON)</i> Test for polarized electrodes. Performed on changeover from the inactive state to a measurement. "OFF" means that the test is not performed.</p>										
temperature cond.	25.0 $^{\circ}$C	<p><i>Titration temperature (-170.0...500.0$^{\circ}$C).</i> Temperature is measured at the start of the titration if a T sensor is connected. The value is used for temperature compensation in pH titrations.</p>										
time interval cond.	2 s	<p><i>Time interval (1...999 999 s)</i> Time interval for acquisition of a measured value into the measuring point list.</p>										

<p>>stop conditions</p> <p>stop V: abs. **titr.</p> <p>stop V 99.99 ml **titr.</p> <p>factor 999999 **titr.</p> <p>filling rate max. ml/min</p>	<p>Stop conditions for titration If this is not "normal", i.e. after reaching the EP.</p> <p><i>Type of stop volume (abs., rel., OFF)</i> "abs.": absolute stop volume in mL. "rel.": relative stop volume to sample size. "OFF": stop volume switched off. Stop volume is not monitored.</p> <p>If "abs." is set: <i>Absolute stop volume (0...9999.99 mL)</i></p> <p>If "rel." is set: <i>Factor for relative stop volume (0...±999 999)</i> Calculated as: Stop V (in mL) = factor * sample size</p> <p><i>Filling rate after the titration (0.01...150 mL/min, max.)</i> <CLEAR> sets "max." The maximum rate depends on the Exchange Unit:</p> <table border="0"> <tr> <td>Exchange Unit</td> <td>max.</td> </tr> <tr> <td>5 mL</td> <td>15 mL/min</td> </tr> <tr> <td>10 mL</td> <td>30 mL/min</td> </tr> <tr> <td>20 mL</td> <td>60 mL/min</td> </tr> <tr> <td>50 mL</td> <td>150 mL/min</td> </tr> </table>	Exchange Unit	max.	5 mL	15 mL/min	10 mL	30 mL/min	20 mL	60 mL/min	50 mL	150 mL/min
Exchange Unit	max.										
5 mL	15 mL/min										
10 mL	30 mL/min										
20 mL	60 mL/min										
50 mL	150 mL/min										
<p>>preselections</p> <p>conditioning: OFF</p> <p>display drift: ON cond.</p> <p>drift corr: OFF cond.</p> <p>drift value 0.0 µl/min cond.</p> <p>req.ident: OFF cond.</p>	<p>Preselections for the sequence</p> <p><i>Automatic conditioning of titration vessel. (ON, OFF)</i> If conditioning is "on", between the titrations the titration solution is constantly maintained at the (1st) end point. When conditioning is performed, the volume drift can be displayed during the conditioning:</p> <p><i>Display of drift during conditioning (ON, OFF).</i> Volume drift.</p> <p><i>Type of drift correction (auto, man. OFF)</i> auto: The value of the drift will be stored automatically at the start of the titration.</p> <p><i>Value for manual drift correction (0...99.9 µL/min)</i></p> <p><i>Request of identifications after start of titration (id1, id1&2, all, OFF)</i> After start, sample identifications can be requested automatically: Only id1, id1 & id2, all three id's or no inquiries.</p>										

req.smpl size: <i>cond.</i>	OFF	<i>Request of sample size after start of titration (value, unit, all, OFF) "all" the value and the unit will be requested.</i>
limit smpl size: <i>cond.</i>	OFF	<i>Limiting value check for sample size (ON, OFF) With "on" the error message "sample size out." appears if the entry is outside the set limits. The limiting values are shown in the display window. The absolute value of the limit is checked during sample size input and during the calculation of the results. If "on" has been set:</i>
low lim. <i>cond.</i>	0.0	<i>Lower limit for sample size (0.0...999 999)</i>
up lim. <i>cond.</i>	999999	<i>Upper limit for sample size (0.0...999 999)</i>
activate pulse: <i>cond.</i>	OFF	<i>Pulse output on I/O line 6 (L6, pin 1) of the remote socket (first, all, cond., OFF) see page 167.</i>

Titration sequence of SET

<START>	
(Activate pulse) (Stirrer ON)	After the start, the activate pulse is outputted and the stirrer switched on.
(Start delay)	The start delay time is waited off.
(Preconditioning) (<START> (Activate pulse) (Start delay)	<p>If conditioning is on, the sample solution is titrated until the (first) EP is reached. The display shows then</p> <p>drift OK 2.3 µl/min</p> <p>or</p> <p>SET pH conditioning</p> <p>The vessel is now conditioned. The titration can be started with <START>.</p>
(Request ident.) (Request smpl size)	<p>The sample identifications and the sample size are requested.</p> <p>The temperature is measured if a T sensor is connected.</p>
(Start conditions)	Pause 1 is waited off, the start volume is dispensed and pause 2 waited off.
(Extraction time) Titration with test of stop criterion	The titration to EP1 then to EP2 is executed. If the extraction time is not yet over when EP1 has been reached, the titration will only be terminated after the extraction time is over.
(Stirrer OFF)	The stirrer is switched off when there is no conditioning.
Calculations	Calculations are carried out.
Data output	Data are outputted.
(Reconditioning)	Conditioning is carried out.

Control parameters

The control parameters can be set separately for each end point. Optimize your control parameters for routine analyses for samples with a rather low content.

During the titration, reagent dosing occurs in 3 phases:

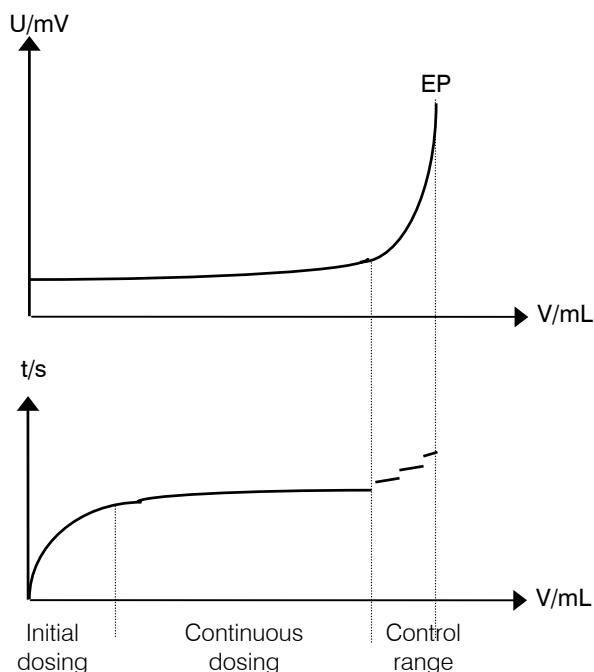

1. Initial dosing:
Here the dosing rate increases constantly. The rate starts with "min.rate" and goes up to "max.rate".
2. Continuous dosing:
Dosing is performed at the maximum rate "max.rate" until the control range (dynamics) is reached.
3. Control range (dynamics):
In this range, dosing is performed in single steps. The last dosing steps are controlled by the parameter "min.rate".

Trial settings for the size of the control range

Set a large control range for steep curves. Relatively flat curves, on the other hand, need a smaller control range. You can get an initial, good approximation for the start of the control range from the intersection point of the tangents:

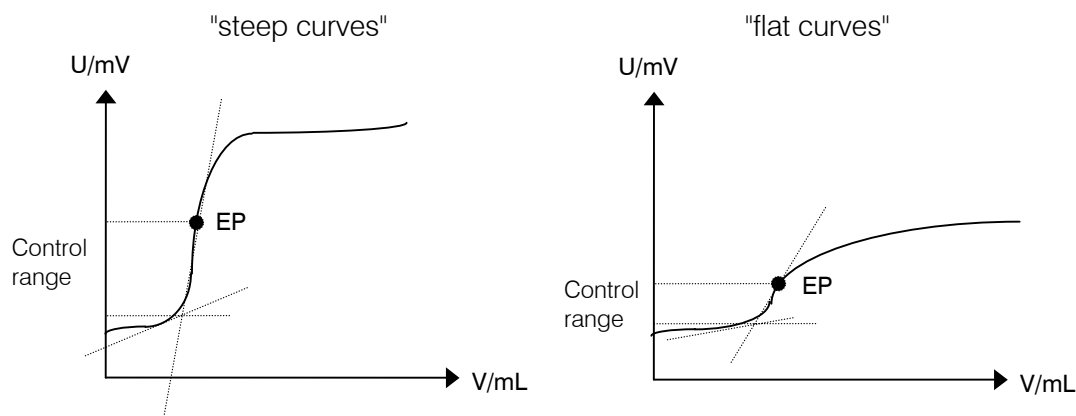

Relation between the stop criteria "time" and "drift"

The stop criterion "time", $t(\text{delay})$, means that the end point must be exceeded for a certain period of time. In other words, after the last dosed increment, time t is allowed to elapse before the titration is stopped. The size of this last increment depends on the volume of the Exchange Unit used. With a 20 mL Exchange Unit, the smallest possible increment is $2 \mu\text{L}$. With a $t(\text{delay}) = 5 \text{ s}$, the last $2 \mu\text{L}$ reagent must thus suffice for 5 s or longer. This results in a drift of $\leq 2 \mu\text{L}/5 \text{ s} = 24 \mu\text{L}/\text{min}$ (the drift can be less than $24 \mu\text{L}/\text{min}$ as it is not known whether the last increment would also suffice for 10 s). If you have been working up to this point with a 20 mL Exchange Unit and a $t(\text{delay}) = 5 \text{ s}$, you can set a value of $\leq 24 \mu\text{L}/\text{min}$ as stop drift. The following table shows several values for the maximum stop drift.

$t(\text{delay})$ min.incr. (Exchange Unit)	5 s	10 s	20 s
$0.5 \mu\text{L}$ (5 mL)	$6 \mu\text{L}/\text{min}$	$3 \mu\text{L}/\text{min}$	$1.5 \mu\text{L}/\text{min}$
$1 \mu\text{L}$ (10 mL)	$12 \mu\text{L}/\text{min}$	$6 \mu\text{L}/\text{min}$	$3 \mu\text{L}/\text{min}$
$2 \mu\text{L}$ (20 mL)	$24 \mu\text{L}/\text{min}$	$12 \mu\text{L}/\text{min}$	$6 \mu\text{L}/\text{min}$
$5 \mu\text{L}$ (50 mL)	$60 \mu\text{L}/\text{min}$	$30 \mu\text{L}/\text{min}$	$15 \mu\text{L}/\text{min}$

Same $t(\text{delay})$ with a range of extremely small volume increments means different switch-off points. In case the stop criterion "drift" is used, the stopping point remains the same.

If you have entered the endpoint and the control range (dynamics), the default values for the other control parameters should suffice for the first titration. If you encounter difficulties in optimizing your titration, the following table will be of use.

How to proceed if ...

Problem	Possible causes and corrective measures
Dosing at the end too long and with too small increments. "Never ends!"	<ul style="list-style-type: none"> • Increase "min.rate". Perform an experiment with a much higher min.rate. • Change switch-off criterion. Attempt, e.g. to increase the stop drift or use a shorter t(delay) as stop criterion. • Possibly pass an inert gas through the titration vessel.
"Overshoots". Titration is not controlled, i.e. at the end single pulses are not dosed.	<ul style="list-style-type: none"> • Lower "max.rate". • Set larger control range. • Set "min.rate" much lower. • Optimize arrangement of electrode and buret tip and improve stirring, see page 160. This is particularly important with very fast titration reactions and with steep curves.
Titration time is too long.	<ul style="list-style-type: none"> • Set higher "min.rate". • Set higher "max.rate". • Lower "dynamics".
Scatter in titration results is too great.	<ul style="list-style-type: none"> • Set "min.rate" lower.

2.6.3 Parameters for MEAS

<pre> parameters >measuring parameters >statistics >preselections </pre>	<p>measuring parameters determine the measurement.</p> <p>statistics: Calculation of mean values and standard deviation, see page 41.</p> <p>preselections: ON/OFF of various auxiliary functions such as automatic requests after the start and activate pulse.</p>
<pre> >measuring parameters signal drift OFF mV/min equilibr.time OFF s meas.input: 1 I(pol) 1 µA U(pol) 400 mV electrode test: OFF </pre>	<p>Measuring parameters</p> <p><i>Drift criterion for measured value acquisition (input range depends on the measured quantity:</i> <i>pH, U, Ipol: 0.5...999 mV/min, OFF</i> <i>Upol: 0.05...99.9 µA/min, OFF</i> <i>T: 0.5...999 °C/min, OFF)</i></p> <p><CLEAR> sets "OFF". "OFF" means that the measured value is acquired after a fixed equilibration time.</p> <p><i>Waiting time for measured value acquisition (0...9999 s, OFF)</i> <CLEAR> sets "OFF". If no new equilibration time has been entered, the Titrino calculates an equilibration time appropriate to the drift with the formula</p> $\text{equilibr.time (in s)} = \frac{150}{\sqrt{\text{Drift} + 0.01}} + 5$ <p>The measured value is acquired when the first criterion (drift or time) is met. With drift and time "OFF", you will have an "infinite" measurement.</p> <p><i>Measuring input for pH and U. (1, 2, diff.)</i> Inquiry only with measured quantities pH and U. Measuring input 1 or 2 or differential amplifier; connection of electrodes, see page 159.</p> <p>With polarized electrodes, instead of the measuring input the <i>polarization current (-127...127 µA)</i> or the <i>polarization potential (-1270...1270 mV, in steps of 10 mV)</i> is inquired.</p> <p><i>Electrode test (OFF, ON)</i> Test for polarized electrodes. Performed on changeover from the inactive standby mode to a measurement. "OFF" means that the test is not performed.</p>

temperature	25.0 °C	<p><i>Temperature (-170.0...500.0 °C)</i> Temperature is measured at the start if a T sensor is connected. This parameter is used for temperature compensation in pH measurements.</p>
time interval	2 s	<p><i>Time interval (1...999 999 s)</i> Time interval for acquisition of measured values.</p>
>preselections		Preselections for the sequence
req.ident:	OFF	<p><i>Request of sample identifications after start of titration (id1, id1&2, all, OFF)</i> After start, sample identifications can be inquired automatically: Only id1, id1 & id2, all three id's or no inquiries.</p>
req.smp1 size:	OFF	<p><i>Request of sample size after start of titration (value, unit, all, OFF)</i></p>
limit smp1 size:	OFF	<p><i>Limiting value check for sample size (ON, OFF)</i> With "on" the error message "sample size out." appears if the entry is outside the set limits. The limiting values are shown in the display window. The absolute value of the limit is checked during sample size input and during the calculation of the results. If "on" has been set:</p>
low lim.	0.0	<i>Lower limit for sample size (0.0...999 999)</i>
up lim.	999999	<i>Upper limit for sample size (0.0...999 999)</i>
activate pulse:	OFF	<p><i>Pulse output on line "activate" (L6, pin 1) of the remote socket (ON, OFF)</i> see page 167.</p>

2.6.4 Parameters for CAL

The calibration interval may be monitored, see page 7.

<pre> parameters >calibration parameters >statistics </pre>	<p>calibration parameters determine the calibration procedure.</p> <p>statistics: Calculation of mean values and standard deviation, see page 41.</p>
<pre> >calibration parameters meas.input: 1 cal.temp. 25.0 °C buffer #1 pH 7.00 buffer #2 pH 4.00 buffer #3 pH OFF signal drift 2 mV/min equilibr.time 110 s electr.id sample changer cal: OFF </pre>	<p>Calibration parameters</p> <p><i>Measuring input (1, 2, diff.)</i> Measuring input 1 or 2 or differential amplifier; Connection of electrodes, see page 159.</p> <p><i>Calibration temperature (-20.0 ... 120.0 °C)</i> If a T sensor is connected, the temperature will be measured. The calibration temperature can also be input during the calibration sequence.</p> <p><i>pH value of first buffer (0...±20.00)</i> The pH value of the buffers can be put in during the calibration sequence.</p> <p><i>pH value of second and the following buffers (0...±20.00, OFF)</i> <CLEAR> sets "OFF".</p> <p>Buffers are requested until "OFF" is set. This gives an n-point calibration. Up to 9 buffers. A regression line will be calculated in calibrations with more than 2 buffers.</p> <p><i>Drift for measured value acquisition (0.5...999 mV/min, OFF)</i> <CLEAR> sets "OFF". "OFF" means that the measured value is acquired after an equilibration time.</p> <p><i>Equilibration time (0...9999 s, OFF)</i> <CLEAR> sets "OFF". If a new equilibration time has not been entered, the Titrino calculates an equilibration time appropriate to the drift, see page 33. The measured value is acquired as soon as the first criterion (drift or time) has been met. If drift and time are both set to "OFF", the measured value acquisition is immediate.</p> <p><i>Electrode identification (up to 8 characters).</i></p> <p><i>Calibration with sample changer (ON, OFF)</i> In calibrations with a sample changer, there are no</p>

activate pulse:	OFF	<p>hold points in the calibration sequence for inputs. Calibration temperature and pH values of the buffers (which are temperature dependent) must therefore be entered in advance. The inputs in key <PARAM> are valid.</p> <p><i>Pulse output on the line "activate" (L6, pin 1) of the remote socket (all, first, OFF)</i></p> <p>See page 167.</p>
------------------------	------------	--

Calibration sequence

<START>	After the start, the activate pulse is output.
(Activate pulse)	
(Start delay)	The start delay time is waited off.
Measuring cal.temp. or entry	Then, the calibration temperature is measured. If no T sensor is connected, you enter the temperature manually. Store the value with <ENTER> or continue with <START> (T is not stored).
Buffer 1 pH	Enter the nominal value of the first buffer. Store the value with <ENTER> or continue with <START> (the value is not stored).
Measuring buffer 1	The first buffer is measured.
Buffer 1 pH	Enter the nominal value of the second buffer. Store the value with <ENTER> or continue with <START> (the value is not stored). Leave the calibration with <STOP> ⇒ 1 point calibration.
Measuring buffer 2	The second buffer is measured.
etc.	As many buffers appear as have been specified in the <PARAM> key (up to 9). You may leave the calibration any time with <STOP>.
Data output	Data are output. The calibration data are available for calculation: C46: pHas C47: Electrode slope Calibration data can be viewed at any time with the <CAL.DATA> key and the calibration report printed out using the key sequence <PRINT><CAL.DATA><ENTER>.

2.6.5 Parameters for TIP

In TIP, several commands and methods can be linked to make a titration procedure. The TIP sequence can be defined with <DEF>, see page 49.

<pre> parameters >sequence >statistics >preselections </pre>	<p>sequence Parameters for the TIP sequence see page 50.</p> <p>statistics: Calculation of mean values and standard deviation, see page 41.</p> <p>preselections: ON/OFF of various auxiliary functions such as automatic requests after the start and activate pulse.</p>
<pre> >preselections req.ident.: OFF req.smpl size: OFF limit smpl size: OFF low lim. 0.0 up lim. 999999 meas.mode: OFF meas.input: 1 I(pol) 1 µA U(pol) 400 mV electrode test: OFF temperature 25.0 °C </pre>	<p>Preselections for the sequence</p> <p><i>Request of sample identifications after start (id1, id1&2, all, OFF)</i> After start, sample identifications can be inquired automatically: Only id1, id1 & id2, all three id's or no inquiries.</p> <p><i>Request of sample size after the start (value, unit, all, OFF)</i></p> <p><i>Limiting value check for sample size (ON, OFF)</i> With "on" the error message "sample size out." appears if the entry is outside the set limits. The limiting values are shown in the display window. The absolute value of the limit is checked during sample size input and during the calculation of the results. If "on" has been set:</p> <p><i>Lower limit for sample size (0.0...999 999)</i> <i>Upper limit for sample size (0.0...999 999)</i></p> <p><i>Measured quantity (pH, U, Ipol, Upol, T, OFF)</i> Quantity for measurements with key <MEAS/HOLD>.</p> <p><i>Measuring input (1, 2, diff.)</i> Inquiry only with measured quantities pH and U. Measuring input 1 or 2 or differential amplifier; connection of electrodes, see page 159.</p> <p>With polarized electrodes, inquiry of <i>polarization current (-127...127 µA) or</i> <i>polarization potential (-1270...1270 mV, steps of 10 mV)</i> <i>Electrode test (OFF, ON)</i></p> <p>Test for polarized electrodes. Performed on changeover from the inactive standby state to a measurement. "OFF" means that the test is not performed.</p> <p><i>Temperature (-170.0...500.0 °C)</i> Temperature for pH compensation. Its value has to be entered manually even if a T sensor is connected.</p>

2.7 Result calculations

Formula entry, key <DEF>

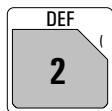

```
def
>formula
>silo calculations
>common variables
>report
>mean
>temporary variables
```

Key <DEF> contains various inquiries for result calculations and data output. The data of this key are method specific and they are stored in the method memory together with the method.

formula:

Formulas for result calculations.

The display texts of the Titrimo are shown to the left. The values are the default values.

```
>formula
```

```
RS?
```

```
RS1=
```

```
RS1=EP1*C01/C00
```

Input of formulas

Enter formula number (1...9)

You can calculate up to 9 results per method. Enter a number 1...9.

Input of formula

Example:

```
RS1=EP1 * C01/C00
```

Enter formula by means of 3rd functions of keyboard. Here you will find operands, mathematical operations and parentheses. Operands require a number as an identification. You can use the following operands:

EPX: EP's. X = 1...9

RSX: Results which have already been calculated with previous formulas. X = 1...9.

CXX: Calculation constants. XX = 00...79.

Rules:

- Calculation operations are performed in the algebraic hierarchy: * and / before + and -.
- Store formula with <ENTER>.
- Calculation quantities and operands can be deleted with <CLEAR> one by one.
- To delete a complete formula press <CLEAR> repeatedly until only RSX remains in the display. Confirm with <ENTER>.

If a formula is stored with <ENTER>, result text, number of decimals and result unit will be requested:

RS1 text	RS1	Text for result output (up to 8 characters) Text input see page 6.
RS1 decimal places	2	Number of decimal places for result (0...5)
RS2 unit:	%	Selection of result unit (% , ppm , g/L , mg/mL , mol/L , mmol/L , g , mg , mL , mg/pc , s , mL/min , no unit or up to 6 characters).
RS1 limit control:	OFF	Limit control for the result (on, off) The limits are checked each time a result is calculated.
RS1 low lim.	0.0	If "on" has been set: Lower limit (0.0...999 999)
RS1 up lim.	0.0	Upper limit (0.0...999 999)
RS1 L13 output:	OFF	Sets line L13 of the remote socket (OFF, active, pulse) if the result lies outside the limits.
Enter next formula, e.g. for RS2.		

Meaning of the calculation variables CXX:

C00	Sample size, see page 59.
C01...C19	Method specific operands, see page 40. They are stored with the method in the method memory.
C21...C23	Sample specific operands, see page 59ff.
C26, 27	Mean values from silo calculations.
C30...C39	Common variables.
C40	Initial measured value of the sample, last measured value in MEAS.
C41	End volume.
C42	Determination time.
C43	Volume drift for SET with conditioning.
C44	Temperature.
C45	Dispensed start volume.
C46	Asymmetry-pH (calibration).
C47	Electrode slope (calibration).
C48	Volume value at maximum voltage in the curve (no evaluation in CAL and TIP).
C49	Volume value at minimum voltage in the curve (no evaluation in CAL and TIP).
C51...C59	Fix EP for DET and MET.
C61...C69	pK/HNP values for DET and MET.
C70...C79	Temporary variables for calculations in TIP.

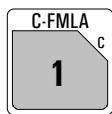
Input method specific operands C01...C19, key <C-FMLA>



With <C-FMLA> the operands C01...C19 can be put in. For the calculation, the operands are used, which were introduced in the formula.

The inputs method specific and are store in method memory.

The calculation report can be printed with the key sequence
<PRINT> <←/→> (press keys repeatedly until "calc" appears in the display) <ENTER>

2.8 Statistics calculation

Mean values, absolute and relative standard deviations are calculated.

 <pre>def >formula >silc calculations >common variables >report >mean >temporary variables</pre>	<p>The <DEF> key is used to allocate results for statistics calculation. The entries are specific to the method and are stored in the method memory.</p> <p>mean: Assigns values for statistics calculations.</p> <p>The display texts of the Titrimo are shown to the left. The values are the default values.</p>
<pre>>mean MN1=RS1 MN2= : MN9=</pre>	<p>Allocations for statistics calculations</p> <p><i>Number n of single values for statistics calculation. (1...9)</i> You can perform statistics calculation using up to 9 results (RSX), endpoints (EPX) or variables (CXX). For MN1, the default value RS1 is entered. Delete allocation with <CLEAR> + <ENTER></p>
	<p>Each mode has an inquiry group ">statistics" in key <PARAM></p>
<pre>>statistics status: OFF mean n= 2 res.tab: original delete n= 1</pre>	<p>Statistics calculation</p> <p><i>Status of statistics calculation (OFF, ON)</i> If the statistics calculation is switched off, the following inquiries regarding the statistics do not appear.</p> <p><i>Mean value calculation from n single results (2...20)</i></p> <p><i>Result table (original, delete n, delete all)</i> "original": The original table is used. Deleted individual results are again incorporated in the evaluation. "delete n": Deletion of single results with the index n. "delete all": The entire table is deleted.</p> <p><i>Delete data from sample number n (1...20)</i> The deleted result is removed from the statistics calculation.</p>

How do you obtain statistics calculations?

- 1) Enter the allocations for the statistics calculation, see page 41.
- 2) Switch on the statistics calculations: Either with <STATISTICS> or set the status under <PARAM>, "> statistics" to "ON". The "STATISTICS" LED is on. Storing a method in the method memory, the status of the statistics calculation is retained.
- 3) Change the number of the individual values n under "mean n", if necessary.
- 4) Perform at least 2 titrations. The statistics calculation are constantly updated and printed. The values are printed in the short and full result report.
- 5) The statistics report can be printed with <PRINT><STATISTICS><ENTER>.

Rules:

- Recalculated results are incorporated in the statistics calculation.
- If a result of a particular titration can not be calculated, no results for this determination are incorporated in the statistics calculation. However, the sample counter is still operative, i.e. the statistics calculation start afresh when the number of required individual determinations has been performed.
- If the statistics are switched off ("statistics" LED no longer on), results are no longer entered in the statistics table. But the table remains unchanged. When the statistics are switched on again, you can immediately continue working.
- If you delete results, all results of the determination with index n are removed from the statistics evaluation.
- On method change, the old statistics table is cleared and the statistics instructions of the new method followed.
- Old results in the statistics table can be deleted with "delete all" (<PARAM>, "> statistics", "res.tab:").

2.9 Common variables

Common variables are used for:

- Determination of a titer with a method. This titer is stored permanently as C3X. The operand C3X can be used in various other methods like any other operand.
- Determination of a blank values with a method . Using this blank value in various other methods.
- Determination of a result with method. Reconciliation of this result in various other methods.

You may view the values of the common variables with <CONFIG>.

<div style="text-align: center; border: 1px solid black; padding: 5px; width: fit-content; margin: 0 auto;"> DEF 2 </div> <pre style="background-color: #f0f0f0; padding: 5px; border: 1px solid black;"> def >formula >silc calculations >common variables >report >mean >temporary variables </pre>	<p>With <DEF>, results (RSX), endpoints (EPX), variables (CXX) or mean values (MNX) can be allocated as common variables. The entries are specific to the method and are stored in the method memory.</p> <p>common variables: Assigns values as common variables.</p> <p>The display texts of the Titrimo are shown to the left. The values are the default values.</p>
<pre style="background-color: #f0f0f0; padding: 5px; border: 1px solid black;"> >common variables C30= C31 : C39= </pre>	<p>Allocation for common variables</p> <p><i>Common variable C30...C39 (RSX, EPX, CXX, MNX)</i> Results (RSX), endpoints (EPX), variables (CXX), and means (MNX) can be assigned. The values of the common variables remain in force for all methods until they are overwritten or deleted. They can be viewed under the <CONFIG> key. Delete allocation with <CLEAR> + <ENTER>.</p>

2.10 Data output

2.10.1 Reports for the output at the end of a determination

 <pre>def >formula >silco calculations >common variables >report >mean >temporary variables</pre>	<p>With <DEF>, the report sequence at the end of the determination is defined. The entries are specific to the method and are stored in the method memory.</p> <p>report: Definition of report blocks to be printed automatically at the end of the determination.</p> <p>The display texts of the Titrimo are shown to the left. The values are the default values.</p>
<pre>>report report COM1: report COM1:full;curve</pre>	<p><i>Report sequence for COM1 (input range depends on the mode:</i></p> <p><i>DET: full, short, mplist, curve, derive, comb, scalc full, scalc srt, param, calc, calib, ff</i></p> <p><i>MET, SET, MEAS:</i> <i>full, short, mplist, curve, scalc full, scalc srt, param, calc, calib, ff</i></p> <p><i>CAL: full, short, scalc full, scalc srt, param, calc, calib, ff</i></p> <p><i>TIP: full, short, scalc full, scalc srt, param, calc, ff</i></p> <p>Select a block. If you require more than one report block, set a ";" as a delimiter between the blocks.</p> <p>Identical for COM2.</p>

Meaning of the report blocks:

full	Full result report with raw results, calculations and statistics.
short	Short result report with calculations and statistics.
mplist	Measuring point list.
curve	Titration curve (with DET and MET) or volume vs. time (with SET) or measured value vs. time (with MEAS)
derive	1st derivative of the titration curve (with DET)
comb	Combined titration curve and 1st derivative (with DET)
scalc full	Full report of silo calculations.
scalc srt	Short report of silo calculations.
param	Parameter report.
calc	Report with formulas and operands.
calib	Calibration data.
ff	Form feed on printer.

Original reports which are put out automatically at the end of the titration can be printed with recalculated values at any time. Key sequence:

<PRINT> <REPORTS> <ENTER>.

Additional possibilities for report outputs

In addition to the reports which are printed at the end of the titration, various other reports can be put out. There are 2 possibilities to select the reports:

- 1) <PRINT> <←/→> <ENTER> Cursor is pressed repeatedly until the desired report appears in the display.
- 2) <PRINT> <keyX> <ENTER> key X is the key under which the appropriate data are entered.

List of the "keys X":

Report	<Key X>
Configuration report	CONFIG
Parameter report	PARAM
Current sample data	SMPL DATA
Statistics report with the individual results	STATISTICS
All sample data from the silo memory	SILO
Calibration data	CAL.DATA
Content of the current card directory	CARD
Operands C01...C19	C-FMLA
Contents of the <DEF> key	DEF
Contents of the method memory with details of the memory requirements of the individual methods and the remaining bytes	USER METH
Complete report sequence of the last determination, as defined under the <DEF> key in the method	REPORTS

Result display without printer

If you work without printer, we recommend to work with the standard character set for result display (settings in key <CONFIG>, ">auxiliaries", see page 10). You will get the complete information on your determinations: Calculated results, endpoints, messages etc.

2.10.2 Display of the titration curve

After the titration, the curve can be viewed.

Switch between "curve" and "result display" with key <CURVE>.

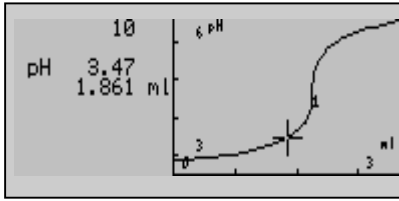

You can trace the curve with keys <↑> and <↓>. In the text field to the left of the curve the index of the current measured value is displayed in the first line. In the subsequent lines, the corresponding measured values are shown.

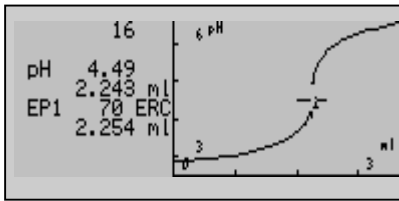

If you place the cursor in DET and MET curves onto the EP, the data of this EP are also shown.

- The EP number and its ERC (Endpoint Recognition Criterion).
- The EP volume.

2.11 User name, key <USER>

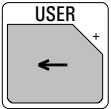
 <pre data-bbox="193 445 595 640"> user name: Boss >delete </pre>	<p>The key <USER> manages the user names. User names can be entered directly or selected with the keys <←> and <→>.</p> <p>Name: Selection or input of user name.</p> <p>Delete: Delete user name.</p> <p>The display texts of the Titrino are shown below at the left.</p>
<pre data-bbox="186 752 595 786"> name: </pre>	<p><i>User name (up to 10 ASCII characters)</i></p> <p>User names can be entered directly or selected with the keys <←> and <→>.</p> <p>The operator name is printed out in the report. The operator name remains in the instrument until it is deleted (or until the RAM is initialized). If no operator name is to be printed out the operator "blank" can be selected.</p>
<pre data-bbox="186 1077 595 1137"> >delete name: </pre>	<p>Delete user name</p> <p>Enter the name directly or select it with the keys <←> and <→>. <ENTER> will delete the name from the list of user names.</p>

2.12 TIP, Titration procedure

TIP (**T**itration **P**rocedure) is used to link several commands in a sequence. TIP is selected with <MODE> and <ENTER>. TIP is an "empty shell" in which the sequence of the determination must be defined.

Definition of the sequence

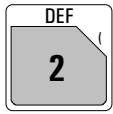
 <pre>def >sequence >formula >silc calculations >common variables >report >mean</pre>	<p>With key <DEF> the TIP can be defined.</p> <p>sequence: of TIP.</p> <p>The display texts of the Titrino are shown to the left. The values are the default values.</p>
<pre>>sequence 1. step: OFF <ENTER> 1. method: 5-TIP <ENTER> etc. 2 x <QUIT></pre>	<p>Sequence</p> <p>Select a step with keys <←> and <→>:</p> <p>method: Method from the user memory or from the card.</p> <p>pause: Waiting time</p> <p>L4, L6 output: Set an output.</p> <p>info: Hold sequence and write a message into the display.</p> <p>stirrer ON/OFF</p> <p>Confirm the step with <ENTER> and enter the parameter for the selected step, see below. The request for the second step follows etc. Up to 30 steps can be selected. On completion of the sequence definition, exit the inquiry with <QUIT>.</p>

Information for the commands (steps):

Command	Meaning	Input range
method	Method from the user memory or from the card. This method runs as a submethod.	Name
pause	Waiting time. The waiting time can be aborted with <QUIT>. <CLEAR> sets "inf" (= infinitely long pause time).	0...999 999 s, inf.
L4, L6 output	Set L4 output (pin 3) resp. L6 output (pin 1) of the remote socket. active = 0 V, inactive = 5 V, pulse > 100 ms, off = output is not used. Cable Titrino (L6) - Dosimat: 6.2139.000. Important: A pulse (e.g. a pulse from monitoring or an activate pulse in a submethod) can set an active output to inactive! At the end of the TIP method, the outputs are set to "inactive".	active, inactive, pulse, off
info	Message in the display . The TIP sequence is held and the message displayed. Continue the sequence with <START>, <QUIT> or <ENTER>.	up to 16 characters
stirrer	Switching stirrer ON/OFF. In TIP the stirrer is not switched automatically in the submethods. At the end of TIP the stirrer is switched off (if stirrer control is ON).	ON, OFF

The parameters of the sequence can be viewed and changed at any time under the <PARAM> key.

Sequence of TIP

As there is no preset sequence of TIP, in what follows the procedure is illustrated by a sequence that contains all available commands.

<START>

(Start delay)

(Request ident.)
(Request spl size)

Switching ON stirrer

The start delay time is waited off.

The sample identifications and the sample size are requested.

Stirrer is switched on. The stirrer is not operated automatically in submethods of TIP. At the end of TIP, however, the stirrer is switched off (with stirrer control ON).

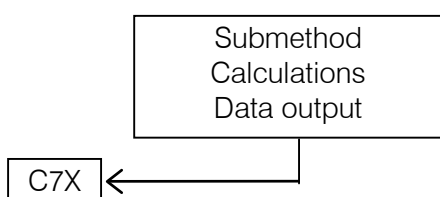

Submethods are processed according to their parameters. They run to completion, including calculations and data output (e.g. curves). The determination data of submethods are overwritten in the next sequence step of TIP. Those values which are needed for higher-level calculations must therefore be assigned to temporary variables C7X.

Pause

The pause is waited off.

Set output

Outputs on the socket "Remote" can be set.

Info

A message can be written in the display. The sequence is held until it is continued manually (with <START>, <QUIT> or <ENTER>).

TIP calculations

TIP higher-level calculations are carried out.

TIP data output

Data output in TIP (TIP contains no more determination data, i.e. curves must be put out within the submethods).

Preparation of submethods for use in TIP

All titration data, i.e. curves and lists of measured points must be put out in the submethod as they are overwritten on return to TIP.

Individual values from the submethod, e.g. endpoints or calculated results must be stored as temporary variables C7X. This allows them to be used in TIP for further calculations.

Reevaluations of data of a submethod are not possible in TIP. The submethods should thus be thoroughly wet tested before they are used in TIP.

Assignment of temporary variables in the submethod:

<div style="text-align: center; border: 1px solid black; padding: 5px; width: fit-content; margin: 0 auto;"> DEF 2 </div> <pre style="background-color: #f0f0f0; padding: 5px; border: 1px solid black;"> def >formula >silco calculations >common variables >report >mean >temporary variables </pre>	<p>With key <DEF> temporary variables can be assigned. The entries are specific to the method and are stored in the method memory.</p> <p>temporary variables for higher-level calculations.</p> <p>The display texts of the Titrino are shown to the left. The values are the default values.</p>
<pre style="padding: 5px;"> >temporary variables C70= C71= : C79= </pre>	<p>Temporary variables</p> <p><i>Assignment of result, endpoints or variables (RSX, EPX, CXX)</i></p> <p>Values of the submethod to be used in TIP calculations.</p>

Calculations in TIP

In TIP calculations variables C7X from different submethods can be used, formula entry see page 38.

Note:

We recommend to execute the calculations in TIP, as they can only be recalculated "dryly" in TIP itself, e.g. with a different sample size.

2.13 Method memory, keys <USER METH> and <CARD>

2.13.1 Key <USER METH>

 <pre data-bbox="268 566 673 763"> user_methods >recall method >store method >delete method </pre>	<p>Management of the internal method memory with key <USER METH>.</p> <p>Select method name with keys <←> and <→>.</p> <p>recall method: Loads a method from the internal method memory into the working memory.</p> <p>store method: Stores the method which is in the working memory in the internal method memory.</p> <p>delete method: Deletes a method from the internal method memory.</p> <p>The display texts of the Titrimo are shown to the left. The values are the default values.</p>
<pre data-bbox="268 1014 673 1122"> >recall method method name: </pre>	<p>Recall method</p> <p><i>Recall method from the internal method memory to the working memory (input of method name, which is included in the memory).</i></p> <p>If a method identification is entered which is not found in the method memory, the selected value blinks.</p>
<pre data-bbox="268 1305 673 1413"> >store method method name: </pre>	<p>Store method</p> <p><i>Store method from the working memory to the internal method memory (up to 8 ASCII characters).</i></p> <p>If a method with an identical name is already stored, you are requested if you wish to overwrite the old method. With <ENTER> it is overwritten, with <QUIT> you return to the entry.</p>
<pre data-bbox="268 1630 673 1738"> >delete method method name: </pre>	<p>Delete method</p> <p><i>Delete method from the internal method memory (input of method name, which is included in the memory).</i></p> <p>For safety, you are again asked if you really wish to delete the method. With <ENTER> it is deleted, with <QUIT> you return to the working memory.</p> <p>If a method name is entered which is not found in the method memory, the selected value blinks.</p>

The contents of the method memory can be printed with the key sequence
<PRINT><USER METH><ENTER>

Document your methods (e.g. parameter report, def. report and C-fmla report)!
With a PC and the 6.6008.XXX Vesuv program, you should carry out a complete method backup from time to time.
Making the backup on the card, pay attention of the exchange date of the battery!

2.13.2 Key <CARD>

<div style="text-align: center; margin-bottom: 10px;">  </div> <pre style="background-color: #f0f0f0; padding: 5px; border: 1px solid #ccc;"> user meth. >recall method >store method >delete method >change directory >create directory >delete directory >backup ↓ </pre>	<p>Management of the method memory on the card with key <CARD >. Select names with keys <←> and <→>.</p> <p>On the first line you find the name of the current directory (here user meth.).</p> <p>recall method: Loads a method from the current directory of the card into the working memory.</p> <p>store method: Stores the method, which is in the working memory, in the current directory of the card.</p> <p>delete method: Deletes a method from the current directory of the card.</p> <p>change directory: Changes the current directory of the card.</p> <p>create directory: Creates a new directory on the card.</p> <p>delete directory: Deletes a directory on the card.</p> <p>backup: Backup of the internal method memory on the card.</p> <p>reload: Reloads a backup from the card into the internal method memory.</p> <p>format: Formats the card.</p> <p>change battery: Date for changing the battery.</p> <p>The display texts of the Titrimo are shown to the left. The values are the default values.</p>
<pre style="background-color: #f0f0f0; padding: 5px; border: 1px solid #ccc;"> >recall method >store method >delete method </pre>	<p>Recall, store, delete method</p> <p>Identical with the corresponding function of the internal method memory. The functions operate on the current directory of the card.</p>
<pre style="background-color: #f0f0f0; padding: 5px; border: 1px solid #ccc;"> >change directory >create directory >delete directory dir.name: </pre>	<p>Change, create, delete directory</p> <p>If a directory is deleted, it is deleted together with all its methods. <i>(directory name with up to 10 characters)</i></p>

<p>>backup</p> <p>dir.name:</p>	<p>Backup of the internal method memory on the card</p> <p><i>(directory name with up to 10 characters)</i> Existing methods in this directory will be deleted, and all methods from the internal method memory are stored in the directory.</p>
<p>>reload</p> <p>dir.name:</p>	<p>Reload methods from the card to the internal method memory</p> <p><i>(directory name with up to 10 characters)</i> Primary all methods from the internal method memory are deleted. Afterwards all methods from the directory of the card are copied into the internal method memory.</p>
<p>>format</p> <p>card label</p> <p>format: no</p>	<p>Format the card</p> <p><i>Card label (with up to 8 characters)</i> The card label will be printed in the card report and in the full result report (if the card is inserted, see page 45).</p> <p><i>Confirmation of formatting the card (yes, no)</i> Upon formatting the card, all data on the card are deleted. After formatting a new card, the date for battery change must be entered.</p>
<p>>change battery</p> <p>date</p>	<p>Battery change date</p> <p><i>Date for changing the battery (YYYY-MM-DD)</i> see page 57.</p>

Possibilities of the card

Methods can be stored on the card.

- Simple exchange of methods between different users, laboratories, factories. Every user can use his card with his own methods. The user specific card label will be printed in the full result report, if the card remains inserted.
- Methods can be stored in different directories, e.g. in directories depending on the sample type or the user.
- The card can be used as an extended memory.
- You will find many application methods on the application card 6.6046.000.

Internal method memory and methods on the card

If methods are called from TIP or from the silo memory, the Titrino will search these methods primary in the internal method memory, and afterwards in the current directory of the card.

Important: We do not recommend not to store identical methods in the current directory of the card as well as in the internal method memory at the same time. Otherwise, you have to update both methods!

Card battery

The card is supplied by a battery. This battery must be changed periodically. Note the lifetime of the battery which is indicated in the manual of the card.

If the card is inserted in the Titrino you will receive a warning if the battery is low on switching on the Titrino or if the battery change date is expired.

The battery is in a case of the card. Read the note enclosed with the card before changing the battery. Leave the card in the Titrino when you change the battery to ensure sufficient power supply.

Important: The battery lifetime refers to a storing temperature of 25 °C. With higher temperatures, the lifetime is shorter.

Therefore do **not**

- carry the card on the body
- store the card near radiators
- have the card in the sun.

Write protection

The write protection prevents all functions, which write on the card (store methods, delete methods, change directory - the current directory is written on the card, create directory, delete directory, backup, format the card, change date of the card battery). Reading functions are possible.

Write protection is on, if the lash in front of the card is on the right.

Reports

- Methods of the current directory, key sequence <PRINT><CARD><ENTER>.
- Methods of the whole card: key sequence <PRINT><←/→><ENTER>; press the cursor keys repeatedly until "card" appears in the display.

Ordering designations

Memory card with 128 Kbytes memory space	6.2245.010
Application card with application file	6.6046.000

2.14 Calibration data, key <CAL.DATA>

 <pre> cal.data >input 1 >input 2 >input diff. </pre>	<p>With <CAL.DATA>, the current pH calibration data of all measuring inputs can be seen. Calibration data are entered here automatically on completion of a calibration.</p> <p>input 1: Calibration data for measuring input 1. Identical for input 2 and diff.</p> <p>The display texts of the Titrino are shown to the left. The values are the default values.</p>
<pre> >input 1 pH(as) 7.00 slope 1.000 temp 25.0 °C cal.date electr.id </pre>	<p>pH calibration data for measuring input 1</p> <p><i>Asymmetry pH (0...±20.00)</i> Entered automatically after a calibration with measuring input 1.</p> <p><i>Slope (0...±9.999)</i> Entered automatically after a calibration with measuring input 1.</p> <p><i>Calibration temperature (-20.0...120.0 °C)</i> Will be printed automatically after calibration with measuring input 1.</p> <p><i>Date of last calibration (no entry possible)</i> If the calibration data "pH(as)" and/or "slope" are changed by a manual entry, the date entry is deleted. This date is the reference date for calibration monitoring, see page 7.</p> <p><i>Electrode identification of calibrated electrodes (no entry possible)</i> If an electrode identification has been entered in the CAL mode, it is automatically entered after the calibration.</p>

The calibration report with the current measuring input data can be printed at any time with the key sequence

<PRINT> <CAL.DATA> <ENTER>.

2.15 Current sample data, key <SMPL DATA>

<div style="text-align: center; border: 1px solid black; width: 60px; margin: 0 auto; padding: 2px;">SMPL DATA</div> <div style="border: 1px solid black; padding: 5px; margin-top: 10px;"> <pre> smp1 data id#1 or C21 id#2 or C22 id#3 or C23 smp1 size 1.0 g smp1 unit: g </pre> </div>	<p>The key <SMPL DATA> can be used to enter the current sample data. The contents of this key change when the silo memory is switched on, see page 61. Instead of entering the current sample data with <SMPL DATA>, you can request these data automatically after start of determinations. Configuration: <PARAM>, ">preselections". Current sample data can be entered live. For working with the silo memory see page 60.</p> <p>id#1...3 or C21...C23, sample identifications: The sample identifications can also be used as sample specific calculation variables C21...C23.</p> <p>smp1 size: Sample size. The sample size can be monitored, see e.g. page 18. The limits are then displayed in this window.</p> <p>smp1 unit: Unit of the sample size.</p> <p>The display texts of the Titrino are shown to the left. The values are the default values.</p>
<pre> smp1 data id#1 or C21 id#2 or C22 id#3 or C23 smp1 size 1.0 g smp1 unit: g </pre>	<p>Sample data</p> <p><i>Sample identification 1...3 or sample specific operand C21...C23 (up to 8 characters).</i> Sample identifications or sample specific operands can be entered using the keypad, via a balance with a special input device or via barcode reader.</p> <p><i>Sample size (6-digit number: ±X.XXXXX)</i> Entry using keypad, via balance or via barcode reader.</p> <p><i>Unit of sample size (g, mg, mL, µL, pc, no unit or up to 5 characters)</i> Select unit with <←/→>.</p>

2.16 Silo memory for sample data

In the silo memory or pushup storage, sample data (method, identifications and smpl size) can be stored. This is useful, e.g. when you work with Sample Changers and other automatic sample addition systems or if you wish an overview of your determination results, see page 64.



Press the key <SILO> for working with the silo memory. The status LED "silo" is on when the silo memory is switched on. The silo memory works by the FIFO principle (First In, First Out).

If the silo memory is switched on, sample data are routed to the last free line of the silo memory. If no new value is put in, the value from the last line is automatically copied. In this manner, data can be simply taken over when they remain unchanged. When the instrument is started, the sample data are fetched from the next silo line.

Organisation of the silo memory

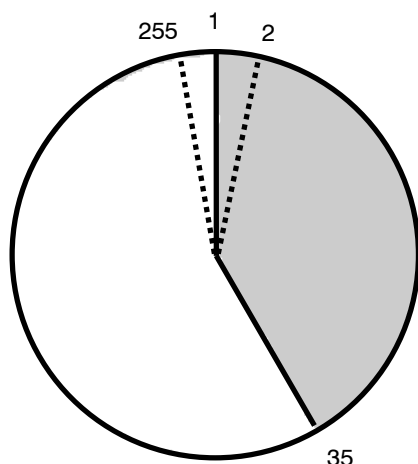

Silo memory contains 35 lines.
Next free line is 36

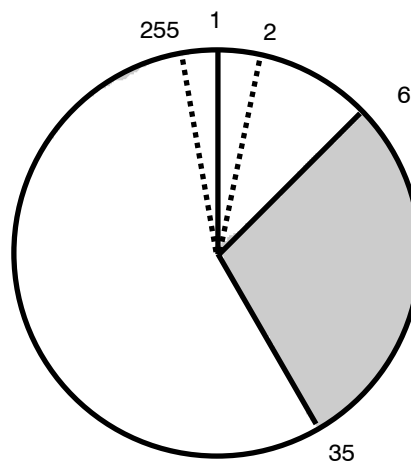

6 of the 35 lines have been processed. Free lines from 36 to 255 and from 1 to 6.

1 silo line needs between 18 and 120 bytes memory capacity.

Filling the silo memory with a connected balance

If the silo memory is filled from the balance, you must ensure that there is sufficient space in the silo memory for the required number of silo lines! The number of free bytes is given in the user memory report.

When the sample data are entered from a balance, the transfer of the sample size is taken as the end of the silo line. You should not send data from the balance and edit the silo memory at the same time.

For mixed operation, manual input of identifications and sample sizes from a balance, the values from the balance are sent into the line in which editing just takes place. Confirmed the data with <ENTER> at the Titrimo.

Key <SMPL DATA> with the silo memory switched on

<div style="text-align: center; border: 1px solid black; padding: 5px; width: fit-content; margin: 0 auto;"> <p>SMPL DATA</p> </div> <div style="border: 1px solid black; padding: 5px; margin-top: 10px;"> <pre> smp1 data >edit silo lines >delete silo lines >delete all silo lines cycle lines: OFF save lines: OFF </pre> </div>	<p>Sample data can be entered into the silo memory with key <SMPL DATA>.</p> <p>edit silo lines: Entering sample data into the silo memory.</p> <p>delete silo lines: Deletes single silo lines.</p> <p>delete all silo lines: Deletes the whole silo memory.</p> <p>The display texts of the Titrino are shown to the left. The values are the default values.</p>
<pre> >edit silo lines silo line 1 method: id#1 or C21 id#2 or C22 id#3 or C23 smp1 size 1.0 g smp1 unit: g </pre>	<p>Input for silo memory</p> <p><i>Silo line (1...255)</i> The next free line is displayed automatically. Lines already occupied can be corrected.</p> <p><i>Method with which the sample is processed (method name from the method memory)</i> If no method name has been entered, the sample is processed with the method in the working memory. Selection of the method with <←/→>.</p> <p><i>Sample identification 1..3 or sample specific calculation variables C21...C23 (up to 8 characters)</i></p> <p><i>Sample size (6-digit number: ±X.XXXXX)</i> The method specific limits are tested on result calculation.</p> <p><i>Unit of sample size (g, mg, mL, µL, pc, no unit or up to 5 characters)</i> Select unit with <←/→>.</p>
<pre> >delete silo lines delete line n OFF </pre>	<p>Delete individual silo lines</p> <p><i>Line number of the line to be deleted(1...255, OFF)</i> <CLEAR> sets "OFF". Deleted lines remain in the silo memory. Access is blocked during the processing. To show that a line has been deleted, they are marked with "*". The symbol * indicates that the line has been deleted. Deleted lines can be reactivated if the appropriate line is re-edited.</p>

<p>>delete all silo lines</p> <p>delete all: no</p>	<p>Delete all silo lines</p> <p><i>Confirmation (yes, no)</i></p> <p>When all silo lines are deleted, the silo is completely empty: The line numbering starts again with 1.</p>
<p>cycle lines: OFF</p>	<p><i>With "ON", worked off silo lines will be copied to the highest line of the silo memory (ON, OFF)</i></p> <p>Data cycling "on" is useful if you constantly have to process the same sample data. In such a case, the processed silo line is not deleted, but copied to the next free line, see below. If you work in this mode, you should not enter any <u>new</u> silo lines during the determinations.</p>
<p>save lines: OFF</p>	<p><i>Store results in the silo memory (ON, OFF)</i></p> <p>Determination results will be stored as C24 or C25 in the silo memory according to the allocations in the methods, see page 64.</p> <p>"save lines" can only be set to "OFF" if the silo is completely empty.</p>

Silo memory with data cycling "on"

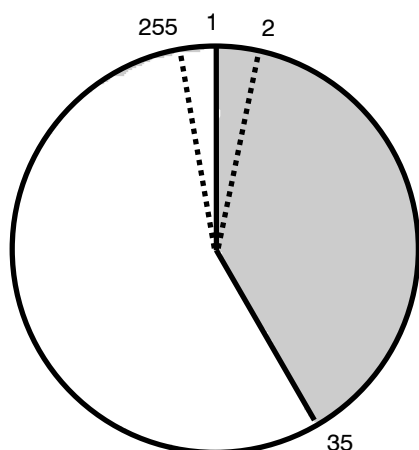

Silo memory contains 35 lines.
Next free line is 36.

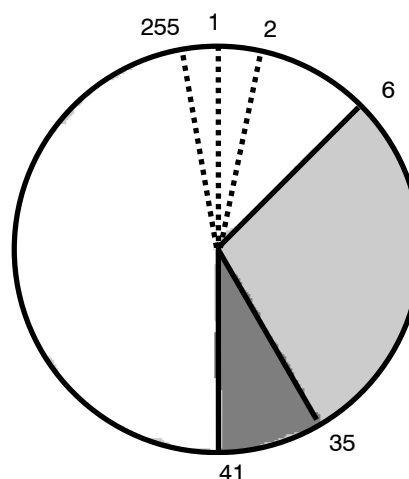

6 of 35 lines have been processed.
The processed lines have been copied to the end of the silo memory: your silo is filled up to line 41.

2.17 Storing determination results and silo calculations

2.17.1 Storing determination results

If the sample-specific data of the silo memory should be kept after the determination and supplemented by results, the following entries are necessary:

1. In the method under <DEF>
Assignment of the determination results to C24 and/or C25:
2. In the silo memory, <SMPL DATA> (when the silo memory is switched in):
"save lines: on"

Assignment of determination results

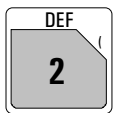
 <pre>def >formula >silo calculations >common variables >report >mean >temporary variables</pre>	<p>The determination results are assigned in key <DEF>.</p> <p>The display texts of the Titrimo are shown to the left. The values are the default values.</p>
<pre>>silo calculations C24= C25=</pre>	<p>Silo calculations</p> <p><i>Assignment to C24 (RSX, EPX, CXX)</i> Calculated results (RSX), endpoints (EPX) or variables CXX can be stored as C24. Same procedure for C25.</p>

Important:

Ensure that there is still sufficient space for storing the results C24 and C25. (In the report <PRINT> <USER METH> <ENTER> the number of free bytes is shown.) Result name, value and unit are stored. The memory requirements can be estimated as follows:

Result with text (8 characters) and unit (5 characters):	32 bytes
Measured value C40, value without unit:	22 bytes

After several samples have been processed, the silo memory report can have the following appearance (printout with <PRINT> <SILO> <ENTER>):

← processed silo
← lines with
← saved results

The silo lines can be marked as follows (at very left of report):

- + Silo line has been processed. It cannot be edited anymore.
- * A silo line not yet processed has been deleted.
- A processed silo line has been deleted and hence removed from the silo calculations.
- / The last processed silo line. Recalculation will be considered e.g., if the sample data of this line are changed.
- No marking: The silo line is awaiting processing.

For silo lines ≥ 100 , the first digit will be overwritten by the marking.

2.17.2 Silo calculations

Mean value and standard deviation of the results available in the silo memory can subsequently be calculated over the entire series.

The following details can be entered in the method under <DEF>:

>sil0 calculations	Silo calculations
C24=	<i>Assignment to C24 and C25</i> Calculated results (RSX), endpoints (EPX) and variables (CXX) can be stored as C24. Identical for C25.
C25=	
match id: OFF	<i>Which sample identifications must match in order to combine of the results (id1, id1&2, all, OFF)</i> "OFF" means no matching ids, all samples which have been processed with the same method are combined, see examples below.

Starting from the following silo report:

```

'si
798 MPT Titrino      01105      798.0010
date 2001-10-19    time 08:54      14
>silo
  cycle lines:      OFF
  save lines:       ON
  sl  method  id 1/C21 id 2/C22 id 3/C23  C00      C24      C25
+ 1   11-2    A/12 94-09-12      0.233g   0.142ml/min 98.53%
+ 2   0-15    A/13 94-09-12      0.286g   0.9976      NV
+ 3   0-15    A/13 94-09-12      0.197g   0.9947      NV
+ 4   11-2    A/12 94-09-12      0.288g   0.138ml/min 95.75%
/ 5   11-2    A/15 94-09-12      0.263g   0.145ml/min 100.61%
    
```

*
Assignment
for C24 only
*
*

with "match id: off" the following silo calculation report (scalc full) is obtained:

```

:
method  id 1/C21 id 2/C22 id 3/C23      mean      +/-s      n
 11-2    *      *      * Rate  0.142ml/min 0.0035  3
          *      *      * Content 98.30%    2.438  3
 0-15    *      *      * Titer  0.9962     0.00105 2
    
```

All samples
which have been
processed with
the same meth-
od are combin-
ed

With "match id: id1" the following silo calculation report (scalc full) is obtained:

```

:
method  id 1/C21 id 2/C22 id 3/C23      mean      +/-s      n
 11-2    A/12    *      * Rate  0.140ml/min 0.0028  2
          *      *      * Content 97.14%    1.966  2
 0-15    A/13    *      * Titer  0.9962     0.00105 2
 11-2    A/15    *      * Rate  0.145ml/min 0.000  1
          *      *      * Content 100.61%   0.000  1
    
```

Sample proc-
essed with the
same method
and having the
same id1 are
combined

The short silo calculation report contains only calculations for the current sample.

```

:
method  id 1/C21 id 2/C22 id 3/C23      mean      +/-s      n
 11-2    A/15    *      * Rate  0.145ml/min 0.000  1
          *      *      * Content 100.61%   0.000  1
    
```

The mean values of the silo calculations are available for further result calculations as C26 and C27 and can be used in the Titrino in formulas.

Mean value of C24 ⇒ C26

Mean value of C25 ⇒ C27

Important:

- If work is performed with silo calculations, the method name must be entered in the silo memory.
- Results will be overwritten in the silo recalculation, as long as the silo line is marked with "/". If you do not wish such an input, e.g. because you work off an urgent sample between a series, disconnect the silo.

- Calculations and assignments are carried out in the following order:
 1. Calculation of the results RSX
 2. Assignment of temporary variables C7X for TIP
 3. Calculation of means MNX
 4. Assignment of silo results C24 and C25
 5. Silo calculations
 6. Assignment of means C26 and C27 from silo calculations
 7. Assignment of common variables C3X

3 Operation via RS232 Interface

3.1 General rules

The Titrino has an extensive remote control facility that allows full control of the Titrino via the RS 232 interface, i.e. the Titrino can receive data from an external controller or send data to an external controller. C_R and L_F are used as terminators for the data transfer. The Titrino sends $2xC_R$ and L_F as termination of a data block, to differentiate between a data line which has C_R and L_F as terminators. The controller terminates its commands with C_R and L_F . If more than one command per line is sent by the controller, “;” is used as a separator between the individual commands.

The data are grouped logically and easy to understand. Thus e.g., for the selection of the dialog language, the following must be sent

&Config.Aux.Language "english"

whereby it is sufficient to only transmit the boldface characters, thus:

&C.A.L "english"

The quantities of the commands above are:

Config	configuration data
Aux	auxiliaries, various data
Language	setting the dialog language

The data are hierarchically structured (tree form). The quantities that occur in this tree are called **objects** in the following. The dialog language is an object which can be called up with the

&Config.Aux.Language

command.

If one is in the desired location in the tree, the value of the object can be queried.

&Config.Aux.Language \$Q Q means Query

The query command \$Q initiates the issuing of the value on the instrument and the value emission is triggered. Entries which start with \$, trigger something. They are thus called **triggers**.

Values of objects can not only be queried, they can also be modified. Values are always entered in quotes, for example:

&Config.Aux.Language "english"

3.1.1 Call up of objects

An excerpt from the object tree is represented below:

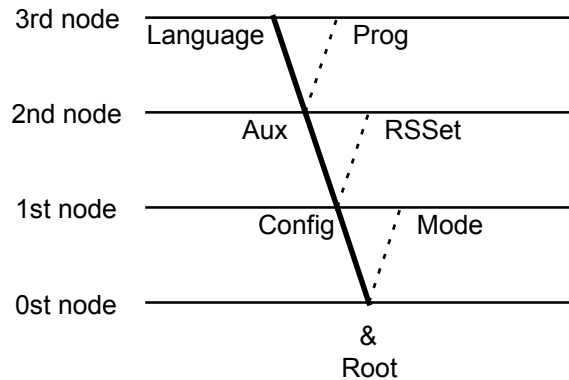

Rules	Example
The root of the tree is designated by &.	
The branches (levels) of a tree are marked with a dot (.) when calling up an object.	
When calling up an object, it is sufficient to give only as many letters as necessary to uniquely assign the object. If the call is not unequivocal, the first object in the series will be recognized.	Calling up the dialog language &Config.Aux.Language or &C.A.L
Upper- or lowercase letters may be used.	&C.A.L or &c.a.l
An object can be assigned a value. Values are signified at the beginning and end by quotes (""). They may contain up to 24 ASCII characters. Numerical values can contain up to 6 digits, a negative sign, and a decimal point. Numbers with more than 6 characters are not accepted; more than 4 decimal places are rounded off. For numbers <1, it is necessary to enter leading zeros.	Entering the dialog language: &C.A.L"english" correct entry of numbers: "0.1" incorrect entry of numbers "1,5" or "+3" or ".1"
The current object remains until a new object is called.	entry of another dialog language: "deutsch"
New objects can be addressed relative to the old object: A preceding dot leads forwards to the next level in the tree.	From the root to node 'Aux': &C.A Forward from node 'Aux' to 'Prog': .P
More than one preceding dot leads one level backwards in the tree. n node backwards require n+1 preceding dots.	Jump from node 'Prog' to node 'Aux' and select a new object 'Language' at this level: ..L
If you must jump back to the root, enter a preceding &.	Change from node 'Language' via the root to node 'Mode': &M

3.1.2 Triggers

Triggers initiate an action on the Titrimo, for example, starting a process or sending data. Triggers are marked by the introductory symbol \$.

The following triggers are possible:

\$G	Go	Starts processes, for ex. starting the mode run or setting the RS 232 interface parameters
\$S	Stop	Stops processes
\$H	Hold	Holds processes
\$C	Continue	Continues processes after Hold
\$Q	Query	Queries all information from the current node in the tree forward up to and including the values
\$Q.P	Path	Queries the path from the root of the tree up to the current node
\$Q.H	Highest Index	Queries the number of son nodes of the current node
\$Q.N"i"	Name	Queries the name of the son node with index i, $i = 1 - n$
\$D	Detail-Info	Queries the detailed status information
\$U	qUit	Aborts the data flow of the instrument, for example, after \$Q

The triggers \$G and \$S are linked to particular objects, see the summary table page 77ff.

All other triggers can be used at any time and at all locations on the object tree.

Examples:

Querying the value of the baud rate: **&Config.RSSet.Baud \$Q**

Querying all values of the node "RSSet": **&Config.RSSet \$Q**

Querying the path of the node "RSSet": **&Config.RSSet \$Q.P**

Start mode: **&Mode \$G**

Querying the detailed status: **\$D**

3.1.3 Status messages

In order to have an efficient control by an external control device, it must also be possible to query status conditions; they provide information on the status of the Titrino. The trigger \$D initiates output of the status. Status messages consist of the global status, the detailed status and eventual error messages, e.g. \$S.Mode.SET;E26. The global status informs on the activity of the process, while the detailed status conditions show the exact activity within the process.

The following **global status conditions** are possible:

\$G	Go:	The Titrino is executing the last command.
\$H	Hold:	The Titrino has been held (\$H, key <meas/hold> or by an error which effects the hold status)
\$C	Continue:	The Titrino has been restarted actively after hold
\$R	Ready:	The Titrino has executed the last command and is ready
\$S	Stop:	A process has been aborted in an "unnatural manner". e.g. stopped or aborted because there was an error.

Detailed status conditions

Status conditions of the global \$G:

\$G	.Mode.DET	.Inac:	Instrument at the beginning or at the end of a titration.
		.Req.Id1:	Instrument in the DET mode, requesting Id1 after titration start.
		.Id2:	Instrument in the DET mode, requesting Id2 after titration start.
		.Id3:	Instrument in the DET mode, requesting Id3 after titration start.
		.Smp1:	Instrument in the DET mode, requesting sample size after titration start.
		.Unit:	Instrument in the DET mode, requesting unit of sample size after titration start.
		.Start:	Instrument in the DET mode, processing the start conditions.
		.Titr:	Instrument in the DET mode, titrating.
\$G	.Mode.MET...		As DET.
\$G	.Mode.SET	.Inac:	Instrument at the beginning or at the end of a titration.
		.Req.Id1:	Instrument in the SET mode, requesting Id1 after start.
		.Id2:	Instrument in the SET mode, requesting Id2 after start.
		.Id3:	Instrument in the SET mode, requesting Id3 after start.
		.Smp1:	Instrument in the SET mode, requesting sample size after start.
		.Unit:	Instrument in the SET mode, requesting unit of sample size after start.
		.Start:	Instrument in the SET mode, processing the start conditions.
		.SET1:	Instrument in the SET mode, titrating to the first endpoint.
		.SET2:	Instrument in the SET mode, titrating to the second endpoint.
		.Cond.Ok:	Instrument in the SET, conditioning, endpoint reached (after the first startup from the standby mode).
		.Cond.Prog:	Instrument in the SET mode, conditioning, endpoint not reached (Conditioning progressing).
\$G	.Mode.MEAS	.Inac:	Instrument at the beginning or at the end of a titration.
		.Req.Id1:	Instrument in the MEAS mode, requesting Id1 after start.
		.Id2:	Instrument in the MEAS mode, requesting Id2 after start.
		.Id3:	Instrument in the MEAS mode, requesting Id3 after start.
		.Smp1:	Instrument in the MEAS mode, requesting sample size after start.
		.Unit:	Instrument in the MEAS mode, requesting unit of sample size after start.
		.Meas:	Instrument in the MEAS mode, measuring.
\$G	.Mode.CAL	.Inac:	Instrument at the beginning or at the end of a calibration
		.Req.Temp:	Instrument in the CAL mode, requesting calibration temperature.
		.Meas.Temp:	Instrument in the CAL mode, measuring calibration temperature.
		.Req.Buf1:	Instrument in the CAL mode, requesting pH of buffer 1.
		.Meas.Buf1:	Instrument in the CAL mode, measures buffer 1.

```

    .Req.Buf2: Instrument in the CAL mode, requesting pH of buffer 2.
    .Meas.Buf2: Instrument in the CAL mode, measures buffer 2.
    etc.
$G .Assembly.Bur .Fill: Buret in filling process
    .ModeDis: Buret in DIS mode

```

In TIP, its global status as well as the step number (X) is available.

```

$G .TIP.X
    .Inac: Instrument at the beginning or at the end of a TIP.
    .Req.Id1: Instrument in the TIP mode, requesting Id1 after start.
    .Id2: Instrument in the TIP mode, requesting Id2 after start.
    .Id3: Instrument in the TIP mode, requesting Id3 after start.
    .Smp1: Instrument in the TIP mode, requesting sample size after start.
    .Unit: Instrument in the TIP mode, requesting unit of sample size after start.
    .Pause: Instrument in the TIP mode, in pause.
    .Info: Instrument in the TIP mode, in info.
    .Mode...: Instrument in the TIP mode, working off a submethod. The detailed
    status messages of the submethod appear, see above.

```

Status conditions of the global \$H:

The status message of the action which has been held appears.
 If the process is held because a monitored limit has been violated, its status message is \$H.Mode.XXX.Titr.

Status conditions of the global \$C:

The status conditions of the global \$C are identical with the ones of the global status \$G. They appear when the process has been restarted actively from the status "Hold" (\$C, key <meas/hold> or automatically after elimination of an error).

Status conditions of the global \$R:

\$R .Mode.XXXX.QuickMeas: Quick manual measurement from the initial status in mode XXXX.

\$R .Mode.DET .Inac: Instrument in the DET mode, inactive.

\$R .Mode.MET .Inac: Instrument in the MET mode, inactive.

\$R .Mode.SET .Inac: Instrument in the SET mode, inactive.

.Cond.Ok: Instrument in the SET mode, conditioning, endpoint reached.

.Cond.Prog: Instrument in the SET mode, conditioning, endpoint not reached.

\$R .Mode.MEAS .Inac: Instrument in the MEAS mode, inactive.

\$R .Mode.CAL .Inac: Instrument in the CAL mode, inactive.

\$R .Assembly.Bur.ModeDis: Buret in the DIS mode, inactive.

\$R .TIP.Inac: Instrument in TIP, inactive.

Status conditions of the global \$\$:

\$\$.Mode.XXXX.QuickMeas: Quick manual measurement from the initial status in mode XXXX.

The instrument gives the status from which it has been stopped. The detailed status information is therefore identical to for the global status \$G.

Violation of monitored limits with action "end" give the status message \$\$.Mode.XXX.Inac;EYYY.

3.1.4 Error messages

Error messages are added to the status messages and separated from them by the sign ";".

E8	Card read/write error. Exit: Send new command.
E9	Wrong card, a card has been removed/inserted during the inquiry. Exit: Send new command.
E10	The card has lost data. Exit: Send new command.
E18	Card battery low (it is between 2.37...2.64 V). Exit: Send new command.
E20	Check exchange unit. Exit: Mount Exchange Unit (properly) or &m \$\$.
E21	Check electrode, short circuit. Exit: Rectify fault or &m \$\$.
E22	Check electrode, break. Exit: Rectify fault or &m \$\$.
E23	Division by zero. Exit: The error message disappears on next startup or on recalculation.
E24	Check drive unit. Exit: Connect drive unit (correctly) or &m \$\$.
E26	Manual stop. Exit: The error message disappears on next startup.
E27	Stop V reached in SET. Exit: The error message disappears on next startup.
E28	Wrong object call up Exit: Send correct path for object. Start path at root.
E29	Wrong value or no value allowed. Exit: Send correct value or call up new object.
E30	Wrong trigger, this trigger is not allowed or carrying-out of action not possible. Exit: Send correct trigger (exception: \$D) or call up new object.
E31	Command is not possible in active status. Repeat command in inactive status. Exit: Send new command.
E32	Command is not possible during titration. Repeat command during the conditioning phase or in inactive status. Exit: Send new command.
E33	Value has been corrected automatically. Exit: Send new command.
E34	Instrument at the end of the titration and sample data is edited; the instrument at rest or editing during filling. Exit: &m \$\$.

RS receive errors:

- E36** Parity
Exit: <QUIT> and ensure settings of appropriate parameters at both devices are the same.
- E37** Framing error
Exit: <QUIT> and ensure settings of appropriate parameters at both devices are the same.
- E38** Overrun error. At least 1 character could not be read.
Exit: <QUIT>
- E39** The internal working-off buffer of the Titrino is full (>82 characters).
Exit: <QUIT>

RS send errors:

- E42** CTS=OFF No proper handshake for more than 1 s.
Exit: <QUIT> Is the receiver switched on and ready to receive?
- E43** The transmission of the Titrino has been interrupted with XOFF for at least 6 s.
Exit: Send XON or <QUIT>
- E45** The receive buffer of the Titrino contains an incomplete command (L_f missing). Sending from the Titrino is therefore blocked.
Exit: Send L_f or <QUIT>.
- E120** Overrange of the primary measured value (pH, U, I_{pol} , U_{pol} or T with MEAS T). The secondary measured value (temperature) may be instable as well.
Exit: Correct error or &m \$\$.
- E121** Measuring point list overflow (more than 500 measuring points).
Exit: The error message disappears on next startup.
- E122** EP overflow.
Exit: The error message disappears on next startup or on recalculation.
- E123** Missing EP for calculation.
Exit: The error message disappears on next startup or on recalculation.
- E124** Number of EP does not correspond with the set windows.
Exit: The error message disappears on next startup or on recalculation.
- E125** Missing fix EP for calculation, has not been defined.
Exit: The error message disappears on next startup or on recalculation.
- E126** Fix-EP outside of measuring point list.
Exit: The error message disappears on next startup or on recalculation.
- E128** No new mean.
Exit: The error message disappears on next startup or on recalculation.
- E129** No new common variable, old value remains.
Exit: The error message disappears on next startup or on recalculation.

- E130** Wrong sample. For SET with preset titration direction the first measured value lies behind the endpoint.
Exit: The error message disappears on next startup.
- E131** No EP set for SET.
Exit: The error message disappears on next startup.
- E132** Silo empty and it has been started with open silo or empty silo has been opened.
Exit: Send a silo entry.
- E133** Silo full.
Exit: Send new command.
- E134** No method. A method, which is required from the silo memory or in TIP, does not exist.
Exit: The error message disappears on next startup.
- E135** Check temp.sensor in MEAS T or with activated temperature monitoring.
Exit: Correct error or &m \$\$.
- E136** Same buffer in CAL. Measured value of the second buffer differs less than 6 mV from the measured value of the first buffer.
Exit: Correct error or &m \$\$.
- E137** XXX Bytes are missing so that the method, the silo line could not be stored or not enough RAM for running TIP.
Exit: Send new command.
- E155** No new silo result (C24 or C25).
Exit: The error message disappears on next start or on recalculation.
- E157** No sequence defined in TIP.
Exit: The error message disappears on next start.
- E158** A second TIP has been called up in TIP.
Exit: The error message disappears on next start.
- E160** No new temporary variable.
Exit: The error message disappears on next start.
- E161** Measurement range of the secondary measured value (temperature) exceeded. The primary measured value (pH, U, Ipol, Upol) can also be unstable.
Exit: Rectify error or &m \$\$.
- E166** Save lines is "OFF" although a submethod of TIP includes an assignment to C24 or C25.
Exit: The error message disappears on next start. Attention: The data of this sample will not be stored.
- E172** In TIP, a QuickMeas was started, without defining a measuring quantity.
Exit: The error message disappears on next start or &Mode.QuickMeas \$\$.
- E177** Accessing to the memory card, the card was not (properly) inserted.
Exit: The error message disappears on next start.
- E178** The date of changing the battery of the card is expired.
Exit: The error message disappears on next start.
- E180** Memory card write-protected.
Exit: Send new command.
- E181** Memory card not formatted.
Exit: Send new command.
- E182** Memory card not accessible.
Exit: Send new command.
- E183** A directory with the same name exists already on the memory card.
Exit: Send new command.

E196	Result is out of limits. Exit: The error message disappears on next start or on recalculation.
E197	Sample size is out of limits. Exit: The error message disappears on next start or on introduction of new sample size.
E198	Validation interval is expired. Exit: The error message disappears on next start or clear counter with &Config.Monitoring.Validation.ClearCount \$G.
E199	Service date is reached. Exit: The error message disappears on next start or change date in &Config.Monitoring.Service.Date.
E205	Calibration interval is expired. Exit: The error message disappears on next calibration or if you delete the calibration.
E212	Transmission error from Remote Box. Unknown characters. Exit: Rectify error and switch Titrino off and on again.
E213	Time-out error from PC keyboard (Remote Box) Exit: Rectify error and switch Titrino off and on again.
E214	Check Remote Box. Remote Box not (properly) connected but activated in &Config.Periph.RemoteBox. Exit: Rectify error and switch Titrino off and on again.
E270	Overload in dosing element. Exit: <STOP> then <CLEAR>. The dosing element will be initialized. If the error reappears, check the wet part.

3.2 Remote control commands

3.2.1 Overview

The internal object tree can be divided into the following branches:

&	Root
Mode	Method parameters
UserMeth	Administration of the internal user-memory for methods
MemoryCard	Administration of the memory card
Config	Instrument configuration
SmplData	Sample specific data
Hotkey	Keys with direct access
Info	Current Data
Assembly	Component data
Setup	Setting the operating mode
Diagnosis	Diagnostics program

&Mode

Object	Description	Input range	Reference
& Root			
Mode	Mode	\$G, \$\$, \$H, \$C	3.2.2.1.
QuickMeas	Rapid meas. in basic mode	\$G, \$\$	3.2.2.2.
Select	Mode selection	DET , MET, SET, MEAS, CAL, TIP	3.2.2.3.
DETQuantity	Measured quantity for DET	pH, U, Ipol, Upol	ditto
METQuantity	Measured quantity for MET	pH, U, Ipol, Upol	ditto
SETQuantity	Measured quantity for SET	pH, U, Ipol, Upol	ditto
MEASQuantity	Measured quantity for MEAS	pH, U, Ipol, Upol, T	ditto
Name	Name of current method	read only/read + write	3.2.2.4.
Parameter*	Parameter of current mode, see below		
Def	Definitions for data output		
Formulas	Calculation formulas		
.1	for result 1		
Formula	Calculation formula	special	3.2.2.5.
TextRS	Text for result output	up to 8 ASCII char	ditto
Decimal	Number of decimal places	0...2...5	ditto
Unit	Unit for result output	up to 6 ASCII char	ditto
Limits	Limits for result	ON, OFF	ditto
LoLim	Lower limit	0...±999 999	ditto
UpLim	Upper limit	0...±999 999	ditto
Output	Output on L13	active, pulse, OFF	ditto
:	up to 9 results		
SiloCalc	Silo calculations		
Assign	Assignment		
C24	Store as variable C24	RSX, EPX, CXX	3.2.2.6.
C25	Store as variable C25	RSX, EPX, CXX	
MatchId	Matching of Id's	id1, id1&2, all, OFF	
ComVar	Assignment of common variables		
C30	for C30	RSX, EPX, CXX, MNX	3.2.2.7.
up to C39			
Report	Reports at the end of determination		
Assign1	Output to COM1	special	3.2.2.8.
Assign2	Output to COM 2	as COM1	
Mean	Assignment for mean calculation		
.1	MN1		
Assign	Input of variable	RSX, EPX, CXX	3.2.2.9.
:			
TempVar	Assignment of temporary variables		
C70	for C70	RSX, EPX, CXX	3.2.2.10.
up to C79			
CFmla	Calculation constants		
.1	Calculation constant C01		
Value	Input of value	0...±999 999	3.2.2.11.
up to C19			

*Parameter	Tree part "Parameters for DET"		
.TitrPara			
Titration parameters			
.MptDensity	Measuring point density	0...4...9	3.2.2.12.
.MinIncr	Minimum increment	0...10.0...999.9	ditto
.DosRate	Dispensing rate for increments	0.01...150.0, max.	3.2.2.13.
.SignalDrift	Drift for meas. value acquisition	depends on meas.quant.	3.2.2.14.
.UnitSigDrift	Unit of measured value drift	read only	ditto
.EquTime	Equilibrium time	0...26...9999, OFF	ditto
.StartV			
Start volume			
.Type	Type of start volume	abs., rel., OFF	3.2.2.15.
.V	Volume for absolute start volume	0...999.99	ditto
.Factor	Factor for relative start volume	0...±999 999	ditto
.Rate	Dispensing rate for start volume	0.01...150.0, max.	ditto
.Pause	Waiting time	0...999 999	3.2.2.16.
.MeasInput	Measuring input	1, 2, diff.	3.2.2.17.
.Ipol	Polarization current	0...1...±127	ditto
.Upol	Polarization voltage	0...400...±1270	ditto
.PolElectrTest	Test for polarized electrodes	ON, OFF	ditto
.Temp	Titration temperature	-170.0...25.0...500.0	3.2.2.18.
.StopCond			
Stop conditions			
.VStop			
Stop volume			
.Type	Type of stop volume	abs. , rel., OFF	3.2.2.19.
.V	Volume for absolute stop volume	0...99.99...9999.99	ditto
.Factor	Factor for relative stop volume	0...±999 999	ditto
.MeasStop	Stop measured value pH, U, I	depends on meas.quant.	3.2.2.20.
.UnitMStop	Unit of stop measured value	read only	ditto
.EPStop	Stop after a number of EP's	1...9, OFF	3.2.2.21.
.FillRate	Filling rate	0.01...150.0, max.	3.2.2.22.
.Statistics			
Statistics			
.Status	Status of statistics calculation	ON, OFF	3.2.2.23.
.MeanN	No. of individual determinations	2...20	ditto
.ResTab			
Result table			
.Select		original , delete n, delete all	ditto
.DelN	Deletion of individual results	1...20	ditto
.Evaluation			
Evaluation			
.EPC	EP criterion	0...5...200	3.2.2.24.
.Recognition			
EP recognition			
.Select	Type of EP recognition	all , greatest, last, window, OFF	ditto
.Window			
Window			
.1	up to 9 windows		
.LowLim	Lower limit window 1	depends on meas.quant.	ditto
.UpLim	Upper limit window 1	depends on meas.quant.	ditto
.FixEP	Fix endpoints		
.1	up to 9 fix EP's		
.Value	Measured value for fix EP1	depends on meas.quant.	ditto
.pK	pK or HNP evaluation	ON, OFF	ditto
.Presel			
Preselections			
.IReq	Request of Id's after start	id1, id1&2, all, OFF	3.2.2.25.
.Sreq	Request of smpl size after start	value, unit, all, OFF	ditto
.LimSmplSize			
Limits for sample size			
.Status	Status of limit control	ON, OFF	ditto
.LoLim	Lower limit	0.0...999 999	ditto
.UpLim	Upper limit	0.0...999 999	ditto
.ActPulse	Output of a pulse	ON, OFF	3.2.2.27.

*Parameter	Tree part "Parameters for MET"		
.TitrPara	Titration parameters		
.VStep	Volume increment	0... 0.10 ...999.9	3.2.2.12.
.DosRate	Dispensing rate for increments	0.01...150.0, max.	3.2.2.13.
.SignalDrift	Drift for meas. value acquisition	depends on meas.quant.	3.2.2.14.
.UnitSigDrift	Unit of measured value drift	read only	ditto
.EquTime	Equilibrium time	0... 26 ...9999, OFF	ditto
.StartV	Start volume		
.Type	Type of start volume	abs., rel., OFF	3.2.2.15.
.V	Volume for absolute start volume	0 ...999.99	ditto
.Factor	Factor for relative start volume	0 ...±999 999	ditto
.Rate	Dispensing rate for start volume	0.01...150.0, max.	ditto
.Pause	Waiting time	0 ...999 999	3.2.2.1.
.MeasInput	Measuring input	1, 2 , diff.	3.2.2.18.
.Ipol	Polarization current	0... 1 ...±127	ditto
.Upol	Polarization voltage	0... 400 ...±1270	ditto
.PolElectrTest	Test for polarized electrodes	ON, OFF	ditto
.Temp	Titration temperature	-170.0... 25.0 ...500.0	3.2.2.19.
.StopCond	Stop conditions		
.VStop	Stop volume		
.Type	Type of stop volume	abs. , rel., OFF	3.2.2.20.
.V	Volume for absolute stop volume	0... 99.99 ...9999.99	ditto
.Factor	Factor for relative stop volume	0...± 999 999	ditto
.MeasStop	Stop measured value pH, U, I	depends on meas.quant.	3.2.2.21.
.UnitMStop	Unit of stop measured value	read only	ditto
.EPStop	Stop after a number of EP's	1 ... 9 , OFF	3.2.2.22.
.FillRate	Filling rate	0.01...150.0, max.	3.2.2.23.
.Statistics	Statistics		
.Status	Status of statistics calculation	ON, OFF	3.2.2.24.
.MeanN	No. of individual determinations	2 ...20	ditto
.ResTab	Result table		
.Select		original , delete n, delete all	ditto
.DeIN	Deletion of individual results	1 ...20	ditto
.Evaluation	Evaluation		
.EPC	EP criterion	depends on meas.quant.	3.2.2.25.
.Recognition	EP recognition		
.Select	Type of EP recognition	all , greatest, last, window, OFF	ditto
.Window	Window		
.1	up to 9 windows		
.LowLim	Lower limit window 1	depends on meas.quant.	ditto
.UpLim	Upper limit window 1	depends on meas.quant.	ditto
.FixEP	Fix endpoints		
.1	up to 9 fix EP's		
.Value	Measured value for fix EP1	depends on meas.quant.	ditto
.pK	pK or HNP evaluation	ON, OFF	ditto
.Presel	Preselections		
.IReq	Request of Id's after start	id1, id1&2, all, OFF	3.2.2.26.
.SReq	Request of sample size after start	value, unit, all, OFF	ditto
.LimSmplSize	Limits for sample size		3.2.2.27
.Status	Status of limit control	ON, OFF	ditto
.LoLim	Lower limit	0.0 ...999 999	ditto
.UpLim	Upper limit	0.0... 999 999	ditto
.ActPulse	Output of a pulse	ON, OFF	3.2.2.28.

*Parameter	Tree part "Parameters for SET"			
.SET1	Control parameters for EP1			
.EP Endpoint 1	depends on meas.quant.	3.2.2.28.		
.UnitEp	Unit of endpoint	read only		ditto
.Dyn	Dynamics	depends on meas.quant.	3.2.2.29.	
.UnitDyn	Unit of dynamics	read only		ditto
.MaxRate	Maximum dosing rate	0.01... 10 ...150, max.		ditto
.MinRate	Minimum dosing rate	0.01... 25.0 ...9999		ditto
.Stop	Titration stop			
.Type	Type of stop criterion	drift , time	3.2.2.30.	
.Drift	Stop drift	1... 20 ...999		ditto
.Time	Switch-off delay time	0... 10 ...999, inf		ditto
.StopT	Stop time	0...999 999, OFF		ditto
.SET2	Control parameters for EP2, as for EP1			
.TitrPara	Titration parameters			
.Direction	Titration direction	+, -, auto	3.2.2.31.	
.XPause	Waiting time before start volume	0 ...999 999	3.2.2.32.	
.Start V	Start volume			
.Type	Type of start volume	abs., rel., OFF	3.2.2.15.	
.V	Volume for absolute start volume	0 ...999.99		ditto
.Factor	Factor for relative start volume	0 ...±999 999		ditto
.Rate	Dispensing rate for start volume	0.01...150.0, max.		ditto
.Pause	Waiting time after start volume	0 ...999 999	3.2.2.16.	
.ExtrT	Extraction time	0 ...999 999	3.2.2.33.	
.MeasInput	Measuring input	1 , 2, diff.	3.2.2.18.	
.Ipol	Polarization current	0... 1 ...±127		ditto
.Upol	Polarization voltage	0... 400 ...±1270		ditto
.PolElectrTest	Test for polarized electrodes	ON , OFF		ditto
.Temp	Titration temperature	-170.0... 25.0 ...500.0	3.2.2.19.	
.TDelta	Time interv. for meas.acquisition	1... 2 ...999 999	3.2.2.34.	
.StopCond	Stop conditions			
.VStop	Stop volume			
.Type	Type of stop volume	abs. , rel., OFF	3.2.2.20.	
.V	Volume for absolute stop volume	0... 99.99 ...9999.99		ditto
.Factor	Factor for relative stop volume	0...± 999 999		ditto
.FillRate	Filling rate	0.01...150.0, max.	3.2.2.23.	
.Statistics	Statistics			
.Status	Status of statistics calculation	ON , OFF	3.2.2.24.	
.MeanN	No. of individual determinations	2 ...20		ditto
.ResTab	Result table			
.Select		original , delete n, delete all		ditto
.DelN	Deletion of individual results	1 ...20		ditto
.Presel	Preselections			
.Cond	Conditioning	ON , OFF	3.2.2.35.	
.DriftDisp	Display of drift during cond.	ON , OFF		ditto
.DCor	Drift correction			
.Type	Type of drift acquisition	auto, man., OFF		ditto
.Value	Drift value for manual drift corr.	0.0 ...99.9		ditto
.IReq	Request of Id's after start	id1, id1&2, all, OFF	3.2.2.26.	
.SReq	Request of smpl size after start	value, unit, all, OFF		ditto
.LimSmplSize	Limits for sample size		3.2.2.27	
.Status	Status of limit control	ON , OFF		ditto
.LoLim	Lower limit	0.0 ...999 999		ditto
.UpLim	Upper limit	0.0... 999 999		ditto
.ActPulse	Output of a pulse	first, all, cond., OFF	3.2.2.28.	

*Parameter	Tree part "Parameters for MEAS"		
.Measuring	Measuring parameters		
.SignalDrift	Drift for meas.value acquisition	depends on meas.quant.	3.2.2.36.
.UnitSigDrift	Unit of measured value drift	read only	ditto
.EquTime	Equilibrium time	0...9999, OFF	ditto
.MeasInput	Measuring input	1, 2, diff.	3.2.2.37.
.Ipol	Polarization current	0...1...±127	ditto
.Upol	Polarization voltage	0...400...±1270	ditto
.PolElectrTest	Test for polarized electrodes	ON, OFF	ditto
.Temp	Titration temperature	-170.0...25.0...500.0	3.2.2.38.
.TDelta	Time interv.for meas.acquisition	1...2...999 999	3.2.2.39.
.Statistics	Statistics		
.Status	Status of statistics calculation	ON, OFF	3.2.2.24.
.MeanN	No. of individual determinations	2...20	ditto
.ResTab	Result table		
.Select		original , delete n, delete all	ditto
.DelN	Deletion of individual results	1...20	ditto
.Presel	Preselections		
.IReq	Request of Id's after start	id1, id1&2, all, OFF	3.2.2.26.
.SReq	Request of sample size after start	value, unit, all, OFF	ditto
.LimSmplSize	Limits for sample size		3.2.2.27
.Status	Status of limit control	ON, OFF	ditto
.LoLim	Lower limit	0.0...999 999	ditto
.UpLim	Upper limit	0.0...999 999	ditto
.ActPulse	Output of a pulse	ON, OFF	3.2.2.28.

*Parameter	Tree part "Parameters for CAL"		
.Calibration	Calibration parameters		
.MeasInput	Measuring input	1, 2, diff.	3.2.2.40.
.CalTemp	Calibration temperature	-20.0...25.0...120.0	3.2.2.41.
.Buffer			
.1			
.Value	pH value of buffer 1	0...7.00...±20.00	3.2.2.42.
.2			
.Value	pH value of buffer 2	0...4.00...±20.00, OFF	ditto
.	up to 9 buffers		
.SignalDrift	Drift for meas.value acquisition	depends on meas.quant.	3.2.2.43.
.EquTime	Equilibrium time	0...26...9999, OFF	ditto
.Electrodel	Electrode identification	8 ASCII char.	3.2.2.44.
.SmplChanger	Calibration on a Titrimo	ON, OFF	3.2.2.45.
.ActPulse	Output of a pulse	first, all, OFF	3.2.2.46.
.Statistics	Statistics		
.Status	Status of statistics calculation	ON, OFF	3.2.2.24.
.MeanN	No. of individual determinations	2...20	ditto
.ResTab	Result table		
.Select		original , delete n, delete all	ditto
.DelN	Deletion of individual results	1...20	ditto

*Parameter	Tree part "Parameters for TIP"		
.Sequence	Sequence		
.1	Step 1		
.Select	Step selection	method,pause,L4 output,L6 output, info,stirrer, OFF	3.2.2.47.
.Method	Method from mem.or card	special	3.2.2.48.
.Pause	Waiting time	0 ...999 999, INF	ditto
.L4Output	Line L4	active,inactive,pulse, OFF	ditto
.L6Output	Line L6	active,inactive,pulse, OFF	ditto
.Info	Display information	up to 16 ASCII char.	ditto
.Stirrer	Stirrer	ON , OFF	ditto
:	up to 30 steps		
.Statistics	Statistics		
.Status	Status of statistics calculation	ON , OFF	3.2.2.24.
.MeanN	No. of individual determinations	2 ...20	ditto
.ResTab	Result table		
.Select		original ,delete n,delete all	ditto
.DelN	Deletion of individual results	1 ...20	ditto
.Presel	Preselections		
.IReq	Request of Id's after start	id1, id1&2, all, OFF	3.2.2.26.
.SReq	Request of sample size after start	value, unit, all, OFF	ditto
.LimSmplSize	Limits for sample size		3.2.2.27
.Status	Status of limit control	ON , OFF	ditto
.LoLim	Lower limit	0.0 ...999 999	ditto
.UpLim	Upper limit	0.0 ... 999 999	ditto
.MeasMode	Measuring mode for man.meas.	pH,U,lpol,Upol,T, OFF	3.2.2.49.
.MeasInput	Measuring input	1 , 2 , diff.	ditto
.Ipol	Polarization current	0 ... 1 ...±127	ditto
.Upol	Polarization voltage	0 ... 400 ...±1270	ditto
.PolElectrTest	Test for polarized electrodes	ON , OFF	ditto
.Temp	Titration temperature	-170.0... 25.0 ...500.0	ditto

.RSSet1	Settings RS232, 1	\$G	3.2.2.81.
.Baud	Baud rate	300,600,1200,2400,4800, 9600 ,19200,38400,57600, 115200	ditto
.DataBit	Number of data bits	7, 8	ditto
.StopBit	Number of stop bits	1 , 2	ditto
.Parity	Parity	even, odd, none	ditto
.Handsh	Handshake	HWs , SWchar, SWline, none	ditto
.RSSet2	as for RS1		
.ComVar	Values of common variables		
.C30	C30	0... ±999 999	3.2.2.82.
up to C39	0... ±999 999		

&Info

Object	Description	Input range	Reference
& Root			
Info	Current data		
- .Report	Transmission of formatted reports	\$G	3.2.2.92.
- .Select	Report type	configuration, parameters, smpl data, statistics, silo, calib C-fmla, def, user method, full , short, mplist, curve, derive, comb, adj para, scalc full, scalc srt, calc, act dir, mem card, all, ff	ditto
- .CalibrationData	pH calibration data	\$G	3.2.2.93.
- .Inp1	For measuring input 1		
- .pHas	Asymmetry pH	0... 7.00 ...±20.00	ditto
- .Slope	Slope of electrode	0... 1.000 ...±9.999	ditto
- .Temp	Calibration temperature	-170.0... 25.0 ...500.0	ditto
- .Date	Date of calibration	read only	ditto
- .ElectrodeId	Id of the calibrated electrode	read only	ditto
- .Inp2	For measuring input 2, as for input 1		
- .Diff	For differential input, as for input 1		
- .Checksums	Checksums	\$G	3.2.2.94.
- .MPList	Checksum of meas.point list	read only	ditto
- .ActualMethod	Checksum of current method	read only	ditto
- .DetermData	Determination data	\$G	3.2.2.95.
- .Write	Read/write for several nods	ON, OFF	
- .ExV	Volume of Exchange/Dosing unit	read only/read + write	ditto
- .MPList	Measuring point list		
- .1	Measuring point 1		
- .Attribute	Attribute	read only/read + write	ditto
- .X	X coordinate	read only/read + write	ditto
- .Y	Y coordinate	read only/read + write	ditto
- .Z1	Z1 coordinate	read only/read + write	ditto
- .Z2	Z2 coordinate	read only/read + write	ditto
	for each measuring point		
- .TitrResults	Titration results		
- .RS	Calculated results		
- .1	1 st result		
- .Value	Value	read only	3.2.2.96.
	up to 9 results		
- .EP	"Info", continuation		
- .1	Endpoint		
- .1	1 st result		
- .V	Value	read only	ditto
- .Meas	Measured value	read only	
- .Mark	Mark if more than 1 EP per window	read only	
	up to 9 EP's		
- .Var	Variables C4X		
- .C40	Start measured value	read only/read + write	ditto
- .C41	Titration end volume	read only/read + write	
- .C42	Titration time	read only/read + write	

.C43	Volume drift in SET	read only/read + write	
.C44	Titration temperature	read only/read + write	
.C45	Start volume	read only/read + write	
.C46	Asymmetry pH	read only	
.C47	Slope of electrode	read only	
.C48	Volume at maximum voltage	read only/read + write	
.C49	Volume at minimum voltage	read only/read + write	
.DTime	Time for drift corr.or dosing time	read only/read + write	
.FixEP	Fix EP		
.51	C51		
.Value	Value	read only	3.2.2.97.
	up to 59		
.pK	pK/HNP		
.61	C61		
.Value	Value	read only	ditto
	up to 69		
.TempVar	Temporary variables C7X		
.C70	up to C79	read only/read + write	ditto
.StatisticsVal	Statistics values		
.ActN	Number of results in chart	read only	3.2.2.98.
.1	1 st mean		
.Mean	Mean	read only	ditto
.Std	Absolute standard deviation	read only	ditto
.RelStd	Relative standard deviation	read only	ditto
	up to 9 mean values		
.SiloCalc	Values of silo calculations		
.C24	Values of variable C24		
.Name	Name	read only	3.2.2.99.
.Value	Value	read only	ditto
.Unit	Unit	read only	ditto
.C25	as for C24		
.C26	Values of variable C26		
.ActN	Number of single values	read only	ditto
.Mean	Mean value	read only	ditto
.Std	Absolute standard deviation	read only	ditto
.RelStd	Relative standard deviation	read only	ditto
.C27	as for C26		
	"Info", continuation		
.ActualInfo	Current data		
.Inputs	I/O Inputs		
.Status	Line status	read only	3.2.2.100.
.Change	Change of line status	read only	ditto
.Clear	Clear change	\$G	ditto
.Outputs	as for I/O Inputs		
.Assembly	From Assembly		
.CyclNo	Cycle number	read only	3.2.2.101.
.Counter	Assembly counter	read only	3.2.2.102.
.V	Volume counter	read only	ditto
.Clear	Clears counter	\$G	ditto
.Meas	Measured value	read only	3.2.2.103.
.Titrator	From Titrator		
.CyclNo	Cycle number	read only	3.2.2.104.
.V	Volume	read only	ditto
.Meas	Measured indicator voltage	read only	ditto
.dVdt	Volume drift dV/dt	read only	ditto
.dMeasdt	Measured value drift	read only	ditto

-	.dMeasdV	1st deviation of titration curve	read only	ditto
-	.ERC	ERC from DET	read only	ditto
-	.T	Temp.as secondary meas.	read only	ditto
-	.MeasPt	Entry in measuring point list		
-	.Index	Index of entry	read only	3.2.2.105.
-	.X	X coordinate	read only	ditto
-	.Y	Y coordinate	read only	ditto
-	.Z1	Z1 coordinate	read only	ditto
-	.Z2	Z2 coordinate	read only	ditto
-	.EP	EP entry		
-	.Index	Index of entry	read only	ditto
-	.X	X coordinate	read only	ditto
-	.Y	Y coordinate	read only	ditto
-	.Display	Display		
-	.L1	Text line 1	up to 32 ASCII char	3.2.2.106.
-		up to line 8		
-	.DelAll	Delete display	\$G	ditto
-	.Comport	Comport		
-	.Number	COM where PC is connected	read only	3.2.2.107.
-	.Assembly	Assembly		
-	.CycleTime	Cycle time	read only	3.2.2.108.
-	.ExV	Volume of Exchange unit	read only	ditto

&Assembly

Object	Description	Input range	Reference
& Root			
-			
- Assembly			
- Bur			
- Rates			
- Forward			
- .Select	Type of rate control	digital, analog	3.2.2.109.
- .Digital	Digital rate	0...150, max.	ditto
- Reverse			
as for forward rate			
- .Select	Type of rate control	digital, analog	ditto
- .Digital	Digital rate	0...150, max.	ditto
- Fill			
Fill			
- ModeDis			
Dispensing			
- .Select	Type of dispensing control	\$G,\$H,\$C	3.2.2.110.
- V	Volume to be dispensed	\$G,\$S,\$H,\$C	3.2.2.111.
- Time	Time to dispense	volume , time	ditto
- VStop	Limit volume	0.0001... 0.1 ...9999	ditto
- AutoFill	Filling after each increment	0.25... 1 ...86 400	ditto
- Meas			
Measuring			
- Status	Measuring ON/OFF	0.0001...9999, OFF	ditto
- MeasInput	Selection of measuring input	ON, OFF	3.2.2.112.
- Ipol	Polarization current	1, 2, diff., Ipol, Upol, Temp	ditto
- Upol	Polarization voltage	0...1...±127	ditto
- Outputs			
I/O outputs			
- AutoEOD	Automatic output of EOD	0... 400 ...±1270	ditto
- SetLines	Set I/O lines	ON, OFF	3.2.2.113.
- LO	Signal on LO	\$G	ditto
- up to L13		active,inactive,pulse, OFF	ditto
- ResetLines	Reset I/O lines	\$G	ditto
- Stirrer			
Stirrer			
		ON, OFF	3.2.2.114.

&Setup

Object	Description	Input range	Reference
& Root			
.			
├ Setup			
	Settings for the operating mode		
├ .Comport	Output of automatic info	1,2,1&2	3.2.2.115.
├ .Keycode	Send key code	ON, OFF	3.2.2.116.
├ .Tree	Sending format of path info		
├ ─ .Short	Short format of path	ON, OFF	3.2.2.117.
├ ─ .ChangedOnly	Paths of modified nodes only	ON, OFF	ditto
├ .Trace	Message on changed values	ON, OFF	3.2.2.118.
├ .Lock	Lock key functions		
├ ─ .Keyboard	Lock all keyboard keys	ON, OFF	3.2.2.119.
├ ─ .Config	Lock <CONFIG> key	ON, OFF	ditto
├ ─ .Parameter	Lock <PARAM> key	ON, OFF	ditto
├ ─ .SmplData	Lock <SMPL DATA> key	ON, OFF	ditto
├ ─ .UserMeth	Lock functions		
├ ─ ─ .Recall	Lock "loading"	ON, OFF	ditto
├ ─ ─ .Store	Lock "saving"	ON, OFF	ditto
├ ─ ─ .Delete	Lock "deletion"	ON, OFF	ditto
├ ─ .Display	Lock display function	ON, OFF	ditto
├ .Mode	Setting waiting intervals		
├ ─ .StartWait	Waiting time after start	ON, OFF	3.2.2.120.
├ ─ .FinWait	Waiting time after run	ON, OFF	ditto
├ .SendMeas	Automatic sending of measured values		
├ ─ .SendStatus	Connect/disconnect sending	ON, OFF	3.2.2.121.
├ ─ .Interval	Time interval	0.08...4...16200, MPList	ditto
├ ─ .Select	Selection	Assembly, Titration	3.2.2.122.
├ ─ .Assembly	From assembly		
├ ─ ─ .CyclNo	Cycle number	ON, OFF	3.2.2.123.
├ ─ ─ .V	Volume	ON, OFF	ditto
├ ─ ─ .Meas	Measured indicator voltage	ON, OFF	ditto
├ ─ .Titration	From Titration		
├ ─ ─ .CyclNo	Cycle number	ON, OFF	3.2.2.124.
├ ─ ─ .V	Volume	ON, OFF	ditto
├ ─ ─ .Meas	Measured indicator voltage	ON, OFF	ditto
├ ─ ─ .dVdt	Volume drift dV/dt	ON, OFF	ditto
├ ─ ─ .dMeasdt	Measured value drift	ON, OFF	ditto
├ ─ ─ .dMeasdV	1st deviation of titration curve	ON, OFF	ditto
├ ─ ─ .ERC	ERC from DET	ON, OFF	ditto
├ ─ ─ .T	Temp.as secondary meas.	ON, OFF	ditto

"Setup", continuation			
Automatic message for changes			
.AutolInfo			3.2.2.125.
.Status	Switch AutolInfo on/off	ON, OFF	ditto
.P	When mains is switched on	ON, OFF	ditto
.T	Titrator infos		
.R	When "ready"	ON, OFF	ditto
.G	When method started	ON, OFF	ditto
.GC	When start is initiated	ON, OFF	ditto
.S	When stopped	ON, OFF	ditto
.B	Begin of method	ON, OFF	ditto
.F	End of process	ON, OFF	ditto
.E	Error	ON, OFF	ditto
.H	When "hold"	ON, OFF	ditto
.C	Continue after "hold"	ON, OFF	ditto
.O	Conditioning OK	ON, OFF	ditto
.N	Conditioning not OK	ON, OFF	ditto
.Re	Request after start	ON, OFF	ditto
.Si	Silo empty	ON, OFF	ditto
.M	Entry in measuring point list	ON, OFF	ditto
.EP	Entry in EP list	ON, OFF	ditto
.RC	Recalculation of results done	ON, OFF	ditto
.C	Comport infos		
.B1	When COM1 sends a report	ON, OFF	ditto
.R1	When COM1 is ready again	ON, OFF	ditto
.B2	When COM2 sends a report	ON, OFF	ditto
.R2	When COM2 is ready again	ON, OFF	ditto
.I	Changing an I/O input	ON, OFF	ditto
.O	Changing an I/O output	ON, OFF	ditto
Graphics			
.Grid	Changing the curve output		
.Grid	Grid on curve	ON, OFF	3.2.2.126.
.Frame	Frame on curve	ON, OFF	ditto
.Scale	Type of depending axis	Full, Auto	ditto
.Recorder	Length of axes		
.Right	Length of meas value axis	0.2... 0.5 ...1.00	ditto
.Feed	Length of paper drive axis	0.01... 0.05 ...1.00	ditto
.PowerOn	RESET (power on)	\$G	3.2.2.127.
.Initialise	Set default values	\$G	3.2.2.128.
.Select	Selection of branch	ActMeth, Config, Silo, Calib	
		Assembly, Setup, All	ditto
.RamInit	Initialization of working mem.	\$G	3.2.2.129.
.InstrNo	Device Identification	\$G	3.2.2.130.
.Value	Input of device identification	8 ASCII characters	ditto

&Diagnose

Object	Description	Input range	Reference
& Root . ├ Diagnose └ .Report	Diagnose Output of adjustment parameters	\$G	3.2.2.131.

3.2.2 Description of the remote control commands

3.2.2.1. Mode \$G, \$S, \$H, \$C
 Start and stop (\$G, \$S) or hold of the current method (3.2.2.3) with \$H and continue with \$C.

\$G also serves to continue after inquiries of identifications and sample size after the start (see 3.2.2.25) as well as after inquiries of calibration temperature and pH values of buffers (see 3.2.2.41 and 3.2.2.42).

3.2.2.2. Mode.QuickMeas \$G, \$S
 Start and stop of a measurement in the basic mode with the parameters (measured quantity, measuring input) of the current method. Corresponds to the <meas/hold> key. In TIP, the measured quantity is selected with &Mode.Parameter.Presel, see 3.2.2.49.

With an ongoing measurement, the current mode can be started. This stops the measurement automatically.

3.2.2.3. Mode.Select DET, MET, SET, MEAS, CAL, TIP
Mode.DETQuantity pH, U, Ipol, Upol
Mode.METQuantity pH, U, Ipol, Upol
Mode.SETQuantity pH, U, Ipol, Upol
Mode.MEASQuantity pH, U, Ipol, Upol, T

Selection of the standard mode. Mode and the measured quantity belong to the complete selection.

If a method is selected from the method memory, the nodes &Mode.Select and &Mode.XXXQuantity are overwritten with mode and measured quantity of the corresponding user method.

3.2.2.4. Mode.Name read only
 Name of the current method in the working memory. \$Q sends 8 ASCII characters. Standard methods carry the name *****. The node can be set read + write, see 3.2.2.95.

3.2.2.5. Mode.Def.Formulas.1.Formula EPX, CXX, RSX, +, -, *, /, (,)
Mode.Def.Formulas.1.TextRS up to 8 ASCII characters
Mode.Def.Formulas.1.Decimal 0...2...5
Mode.Def.Formulas.1.Unit up to 6 ASCII characters
Mode.Def.Formulas.1.Limits ON, OFF
Mode.Def.Formulas.1.LoLim 0...±999 999
Mode.Def.Formulas.1.UpLim 0...±999 999
Mode.Def.Formulas.1.Output active, pulse, OFF
Mode.Def.Formulas.2.Formula
 etc. up to .9

Entry of formulas. Rules for formula entry, see page 38.

Example: "(EP2-EP1)*C01/C00"

In addition to the formula, a text for result output, the number of decimal places and a unit for the result output can be selected. "No unit" is selected with the blank string.

In place of "RSX", a result name may be entered (.TextRS). This name is outputted in the report full, short, scalc full and scalc srt. It is used for the result and the corresponding mean value.

The limit control for results can also be activated. If a result is out of limit, a message appears in the result report, E196 is sent, and output line L13 can be set.

3.2.2.6. Mode.Def.SiloCalc.Assign.C24 RSX, EPX, CXX
Mode.Def.SiloCalc.Assign.C25 RSX, EPX, CXX
Mode.Def.SiloCalc.MatchId id1, id1&2, all, **OFF**

.Assign.C2X: Assignment to store results in the silo as C2X.

.MatchId: Indication which sample identification(s) have to match so that the results can be combined.

3.2.2.7. Mode.Def.ComVar.C30 RSX, MNX, EPX, CXX
Mode.Def.ComVar.C31
 etc., up to **.C39**

Assignment of common variables.

The values of the common variables are to be found in &Config.ComVar. They can be viewed and entered there, see 3.2.2.82.

3.2.2.8. Mode.Def.Report.Assign1
Mode.Def.Report.Assign2
 DET: full, short, mplist, curve, derive comb, scalc full, scalc srt, calc, param, calib, ff
 MET, SET, MEAS: full, short, mplist, curve, scalc full, scalc srt, calc, param, calib, ff
 CAL: full, short, scalc full, scalc srt, calc, param, calib, ff
 TIP: full, short, scalc full, scalc srt, calc, param, ff

Definition of the report sequence, which is outputted automatically at the end of the determination. Entries of more than one block have to be separated with ":",

.Assign1: Output to COM1 of the Titrimo. Identical for COM2.

3.2.2.9. Mode.Def.Mean.1.Assign **RS1**, RSX, EPX, CXX
Mode.Def.Mean.2.Assign
 etc., up to **.9**

Assignment of the statistics calculations. Valid assignments are a requirement for statistics calculations. In addition, the statistics calculation must be switched on, see 3.2.2.23. Rules for statistics calculations see page 41.

3.2.2.10. Mode.Def.TempVar.C70 RSX, EPX, CXX
 etc. up to **.C79**

Assignment of temporary variables in a submethod for calculations in TIP.

3.2.2.11. Mode.CFmla
Mode.CFmla.1.Value **0...±999 999**

Mode.CFmla.2.Value
etc., up to **.19**

Calculation constants specific to a method. Stored in the method memory of the Titrino. Operands specific to the sample (3.2.2.84 and 3.2.2.85) and values of common variables (3.2.2.82) on the other hand are not stored with the methods.

3.2.2.12. Mode.Parameter.TitrPara.MptDensity 0...**4**...9
Mode.Parameter.TitrPara.MinIncr 0...**10.0**...999.9
Mode.Parameter.TitrPara.VStep 0...**0.10**...9.999

.MptDensity: Parameter for DET: Measuring point density.

.MinIncr: Parameter for DET: Minimum increment in μL . If the minimum increment is set to 0, measured values are stored vs. time.

.VStep: Parameter for MET: Volume increment in mL. With "0", there is no dispensing and measured values vs. time are entered in the measuring point list.

3.2.2.13. Mode.Parameter.TitrPara.DosRate 0.01...150, **max.**

Parameters for DET and MET: Dispensing rate for the volume increments in mL/min. Max. means maximum possible dispensing rate with the Exchange Unit in current use.

3.2.2.14. Mode.Parameter.TitrPara.SignalDrift pH,U,Ipol:0.5...**50**...999, OFF
 Upol: 0.05...**50**...99.9, OFF
Mode.Parameter.TitrPara.UnitSigDrift read only
Mode.Parameter.TitrPara.EquTime 0...**26**...9999, OFF

Parameters for DET and MET: Criteria for the measured value acquisition.

Measured value drift in mV/min (with pH, U, Ipol) or $\mu\text{A}/\text{min}$ (with Upol), equilibration time in s. OFF means that the corresponding criterion is switched off. If both criteria are OFF, the measured values are acquired immediately after dispensing.

If the equilibration time has never been edited, it is automatically calculated by the instrument to match the drift, see page 19. After it has been edited once, it remains in force with the set value.

3.2.2.15. Mode.Parameter.TitrPara.StartV.Type abs., rel., **OFF**
Mode.Parameter.TitrPara.StartV.V 0...999.99
Mode.Parameter.TitrPara.StartV.Factor 0... \pm 999 999
Mode.Parameter.TitrPara.StartV.Rate 0.01...150, **max.**

Parameters for DET, MET, SET: Start volume.

If an absolute start volume (abs.) has been selected, the volume in mL is valid.

A relative start volume (rel.) is dispensed as a function of the sample size:

Start volume in mL = $\text{smpI size} * \text{factor}$

The factor is valid.

The dispensing rate in mL/min applies to both cases. Max. means maximum possible dispensing rate with the Exchange Unit in current use.

- 3.2.2.16. Mode.Parameter.TitrPara.Pause** 0...999 999
Parameters for DET, MET, SET: Pause time in s. Is waited off after the dispensing of the start volume.
- 3.2.2.17. Mode.Parameter.TitrPara.MeasInput** 1, 2, diff.
Mode.Parameter.TitrPara.Ipol -127...1...+127
Mode.Parameter.TitrPara.Upol -1270...400...+1270
Mode.Parameter.TitrPara.PolElectrTest ON, OFF
Parameters for DET, MET, SET:
Selection of the measuring input; valid with measured quantities pH and U.
"diff." means differential amplifier, see page 159.
With Ipol, the inquiries for the polarization current in μA (Ipol) and .PolElectrTest are valid.
With Upol, the inquiry for the polarization voltage in mV (Upol) is valid. Entry in steps of 10 mV.
Besides .PolElectrTest is valid.
If the test for polarized electrodes is switched on, it is performed on change-over from the inactive state to an active state (titration or conditioning).
- 3.2.2.18. Mode.Parameter.TitrPara.Temp** -170.0...25.0...500.0
Parameters for DET, MET, SET: Titration temperature in $^{\circ}\text{C}$. If a Pt100 or Pt1000 is connected, the temperature is measured continuously and the parameter .Temp is updated.
The temperature is used for the temperature correction in pH measurements.
- 3.2.2.19. Mode.Parameter.StopCond.VStop.Type** abs., rel., OFF
Mode.Parameter.StopCond.VStop.V 0...99.99...9999.99
Mode.Parameter.StopCond.VStop.Factor 0...±999 999
Parameters for DET, MET, SET: Stop volume.
If an absolute stop volume (abs.) has been selected, the volume in mL is valid.
A relative stop volume (rel.) is dispensed as a function of the sample size:
Stop volume in mL = smpl size * factor
The factor is valid.
OFF means that the criterion is not monitored.
- 3.2.2.20. Mode.Parameter.StopCond.MeasStop** pH: 0...±20.00, OFF
U: 0... ±2000, OFF
I: 0...200.0, OFF
Mode.Parameter.StopCond.UnitMStop read only
Parameters for DET and MET: Stop when a measured value is reached. Entry as pH value, in mV (with U and Ipol) and in μA (with Upol). The appropriate unit can be viewed with .UnitMStop.
OFF means that the criterion is not monitored.
- 3.2.2.21. Mode.Parameter.StopCond.EPStop** 1...9, OFF
Parameters for DET and MET: Stop when a certain number of EP's has been found.

OFF means that the criterion is not monitored.

3.2.2.22. Mode.Parameter.StopCond.FillRate 0.01...150, **max.**
 Parameters for DET, MET, SET: Filling rate in the titration in mL/min. Max.
 means maximum possible filling rate with the Exchange Unit in current use.

3.2.2.23. Mode.Parameter.Statistics.Status ON, **OFF**
Mode.Parameter.Statistics.MeanN 2...20
Mode.Parameter.Statistics.ResTab.Selected **original**, delete n,
 delete all
Mode.Parameter.Statistics.ResTab.DeIN 1...20

Entries for the statistics calculations.

.Status: On/off switching. Requirement for statistics calculations is a valid assignment, see 3.2.2.9.

.MeanN: Number of individual results for statistics calculations.

.ResTab.Select: Selection of the table for the statistics calculations.

original: Original table. The original table is (again) set up, i.e. any individual results which have been deleted are reincorporated in the statistics calculations.

delete n: Single result lines are removed from the statistics calculation. All results of the corresponding line in the statistics table are deleted. Specification of the line number in .ResTab.DeIN.

delete all: Clear entire statistics table. The results can not be reactivated.

.ResTab.DeIN: Specification of the line number to be deleted.

3.2.2.24. Mode.Parameter.Evaluation.EPC DET: 0...5...200
 MET pH: 0.1...0.50...9.99
 U, Ipol: 1...30...999
 Upol: 0.1...2...99.9

Mode.Parameter.Evaluation.Recognition.Selected **all**, greatest,
 last, window, OFF

Mode.Parameter.Evaluation.Recognition.Window.1.LowLim
 pH: 0...±20.00, **OFF**
 U, Ipol: 0...±2000, **OFF**
 Upol: 0...±200.0, **OFF**

Mode.Parameter.Evaluation.Recognition.Window.1.UpLim
 Input range as LowLim

etc. up to 9 windows

Mode.Parameter.Evaluation.FixEP.1.Value pH: 0...±20.00, **OFF**
 U; Ipol: 0...±2000, **OFF**
 Upol: 0...±200.0, **OFF**

etc. up to 9 fix EP's

Mode.Parameter.Evaluation.pK ON, **OFF**

Parameters for DET and MET: Evaluation of the EP's, see page 20.

.EPC: EP criterion in pH, in mV (with U and Ipol) or in μA (with Upol).

.Recognition.Selected: EP recognition.

all: All endpoints found are recognized.

great: Only the largest EP is recognized.

last: Only the last EP is recognized.

window: Only EP's that lie within set windows are recognized.

OFF: The EP evaluation is switched off.

.Recognition.Window.1.LowLim: Lower limit for window in pH, mV (with U and Ipol) or μA (with Upol).

.Recognition.Window.1.UpLim: Upper limit for window in pH, mV (with U and Ipol) or μA (with Upol).

Windows are opened until the lower limit is set to OFF. For every expected EP, an individual window must be set, see page 22.

.FixEP.1.Val: Fix-EP's in pH, mV (for U, Ipol) resp. μA (for Upol). Fix EP's are evaluated until the setting OFF is found.

.pK: pK or HNP evaluation. Possible only in pH and U titrations.

3.2.2.25. Mode.Parameter.Presel.IReq id1, id1&2, all, **OFF**
Mode.Parameter.Presel.SReq value, unit, all, **OFF**

Parameters for DET, MET, SET, MEAS: Automatic inquiry after the start of the determination. From such an inquiry, the determination continues if the requested entry/entries is/are made, e.g. &SmplData.OFFSilo.Id1 (see 3.2.2.84) or with &M \$G, see 3.2.2.1.

\$H is not possible in requests.

3.2.2.26. Mode.Parameter.Presel.LimSmplSize.Status ON, **OFF**
Mode.Parameter.Presel.LimSmplSize.LoLim 0.0...999 999
Mode.Parameter.Presel.LimSmplSize.UpLim 0.0...999 999

Limit control for the sample size.

3.2.2.27. Mode.Parameter.Presel.ActPuls ON, **OFF**
for SET: first, all, cond., **OFF**

Output of a pulse on the I/O line "Activate", see page 167.

3.2.2.28. Mode.Parameter.SET1.EP pH: 0...±20.00, **OFF**
U, Ipol: 0...±2000, **OFF**
Upol: 0...±200.0, **OFF**
Mode.Parameter.SET1.UnitEp read only

Parameters for SET: Setting the 1st endpoint as pH value, in mV (with U and Ipol) resp. μA (with Upol). The corresponding unit can be read with .UnitEP.

If the value is on "OFF", no further nodes will appear from SET1.

3.2.2.29. Mode.Parameter.SET1.Dyn pH: 0.01...20.00, **OFF**
U, Ipol: 1...2000, **OFF**
Upol: 0.1...200.0, **OFF**
Mode.Parameter.SET1.UnitDyn read only
Mode.Parameter.SET1.MaxRate 0.01...10...150, max.
Mode.Parameter.SET1.MinRate 0.01...25.0...999.9

Parameters for SET: Control parameters, see page 30.

.Dyn: Dynamics, control range in pH, mV (with U and Ipol) or μA (with Upol). The corresponding unit can be read with .UnitDyn.

.MaxRate: Maximum allowed titration rate in mL/min. Max. means maximum possible rate with the Exchange Unit in current use.

.MinRate: Minimum titration rate in ul/min.

3.2.2.30. Mode.Parameter.SET1.Stop.Type drift, time
Mode.Parameter.SET1.Stop.Drift 1...20...999
Mode.Parameter.SET1.Stop.Time 0...10...999, inf
Mode.Parameter.SET1.Stop.StopT 0...99 999, **OFF**

Parameters for SET: Type and size of the stop criterion of the titration.

.Type: Type of stop criterion after stop drift or switch-off delay time.

.Drift: Stop drift in ul/min. Applies when "drift" has been selected.

.Time: Switch-off delay time in s. Applies when "time" has been selected. "inf" means infinite.

.StopT: Stop time in s. Applies when "time" has been selected and the value of .Time is set to "inf."

3.2.2.31. Mode.Parameter.TitrPara.Direction +, -, **auto**

Parameters for SET: Titration direction.

"auto" means the titration direction is determined automatically by the instrument. If 2 EP's have been set in a SET titration, the titration direction is given by the two EP's. The entry of the titration direction is then invalid.

3.2.2.32. Mode.Parameter.TitrPara.XPause 0...999 999

Parameter for SET: Pause time in s. Runs before dosing the start volume.

3.2.2.33. Mode.Parameter.TitrPara.ExtrT 0...999 999

Parameter for SET: Extraction time in s.

3.2.2.34. Mode.Parameter.TitrPara.TDelta 1...2...999 999

Parameter for SET: Time interval in s for the entry of a measurement point in the list of measured points.

3.2.2.35. Mode.Parameter.Presel.Cond ON, **OFF**

Mode.Parameter.Presel.DriftDisp ON, **OFF**

Mode.Parameter.Presel.DCor.Type auto, man., **OFF**

Mode.Parameter.Presel.DCor.Value 0.0...99.9

Parameters for SET:

.Cond: Conditioning ON/OFF

.DriftDisp: Drift display during conditioning ON/OFF.

.DCor.Type: Type of drift take-over for the drift correction. auto: Take-over of the drift value at start.

.DCor.Value: Drift value for the manual drift correction.

3.2.2.36. Mode.Parameter.Measuring.SignalDrift
 pH, U, Ipol, T: 0.5...999, **OFF**
 Upol: 0.05...99.9, **OFF**

Mode.Parameter.Measuring.UnitSigDrift read only

Mode.Parameter.Measuring.EquTime 0...9999, **OFF**

Parameters for MEAS: Criteria for the measured value acquisition. Measured value drift in mV/min (with pH, U, I_{pol}, T), μ A/min (with U_{pol}), resp. °C/min (with T). Equilibration time in s. OFF means that the corresponding criterion is switched off. If both criteria are OFF, the measurement continues indefinitely. If the equilibration time has never been edited, it is automatically calculated by the instrument to match the drift, see page 33. After it has been edited once, it remains in force with the set value.

3.2.2.37. Mode.Parameter.Measuring.MeasInput 1, 2, diff.
Mode.Parameter.Measuring.Ipol $\pm 127 \dots 1 \dots +127$
Mode.Parameter.Measuring.Upol $\pm 1270 \dots 400 \dots +1270$
Mode.Parameter.Measuring.PolElectrTest ON, OFF

Parameters for MEAS:

Selection of the measuring input; valid with measured quantities pH and U. "diff." means differential amplifier, see page 159.

With I_{pol}, the inquiries for the polarization current in μ A (I_{pol}) and .PolElectrTest are valid.

With U_{pol} the inquiry for the polarization voltage in mV (U_{pol}) is valid. Entry in steps on 10 mV.

Besides .PolElectrTest is valid.

If the test for polarized electrodes is switched on, it is performed on change-over from the inactive state to the measurement.

3.2.2.38. Mode.Parameter.Measuring.Temp -170.0...**25.0**...500.0

Parameters for MEAS: Measurement temperature in °C. If a Pt100 or Pt1000 is connected, the temperature is measured.

The temperature is used for the temperature correction in pH measurements.

3.2.2.39. Mode.Parameter.Measuring.TDelta 1...**2**...999 999

Parameters for MEAS: Time interval in s for the acquisition of a measured value into the measuring point list.

3.2.2.40. Mode.Parameter.Calibration.MeasInput 1, 2, diff.

Parameters for CAL: Selection of the measuring input. "diff." means differential amplifier, see page 159.

3.2.2.41. Mode.Parameter.Calibration.CalTemp -20.0...**25.0**...120.0

Parameters for CAL: Calibration temperature in °C. If a Pt 100 or Pt1000 is connected, the temperature is measured.

3.2.2.42. Mode.Parameter.Calibration.Buffer.1.Value 0...**7.00**... ± 20.00

Mode.Parameter.Calibration.Buffer.2.Value 0...**4.00**... ± 20.00 , OFF etc. up to 9 buffers

Parameters for CAL: pH of buffers. The first buffer which is set to "OFF" determines the number of buffers in the calibration.

3.2.2.43. Mode.Parameter.Calibration.SignalDrift 0.5...2...999, OFF
Mode.Parameter.Calibration.EquTime 0...110...9999, OFF

Parameters for CAL: Criteria for measured value acquisition. Measured value drift in mV/min, equilibration time in s. OFF means that the corresponding criterion is switched off. If both criterions are on OFF, the measured value is acquired immediately.

If the equilibration time has never been edited, it is automatically calculated by the instrument to match the drift, see page 19. After it has been edited once, it remains in force with the set value.

3.2.2.44. Mode.Parameter.Calibration.ElectrodeId up to 8 ASCII char
Parameters for CAL: Electrode identification. It is classified under calibration data, see 3.2.2.93.

3.2.2.45. Mode.Parameter.Calibration.SmplChanger ON, OFF
Parameters for CAL: Calibration at Titrino.
With "ON", there are no hold points in the calibration sequence for entries, the first buffer is measured directly.

3.2.2.46. Mode.Parameter.Calibration.ActPulse first, all, OFF
Parameters for CAL: Output of a pulse on the I/O line "Activate", see page 167.

3.2.2.47. Mode.Parameter.Sequence.X.Select method, pause, L4 output, L6 output, info, stirrer, OFF
Parameters for TIP: Selection of an element for step X (X = 1...30). For the parameters of the elements see 3.2.2.48.

3.2.2.48. Mode.Parameter.Sequence.X.Method Method name
Mode.Parameter.Sequence.X.Pause 0...999 999, INF
Mode.Parameter.Sequence.X.L4Output active, inactive, pulse, OFF
Mode.Parameter.Sequence.X.L6Output as for L4
Mode.Parameter.Sequence.X.Info up to 16 ASCII characters
Mode.Parameter.Sequence.X.Stirrer ON, OFF

Parameters for TIP: Parameters of the elements of TIP.

.Method: Method name of a method available in the user memory or on the card. Up to 8 ASCII characters.

.Pause: Pause time in s. INF means infinite. Continue the sequence with &m \$G.

.L4 Output: Warning: A pulse triggered by the limit value monitoring at L4 (pin 3) in a submethod sets an output set to active in TIP to inactive.

.L6 Output: Warning: An activate pulse at L6 output (pin 1) in a submethod sets an output set to active in TIP to inactive.

.Info: Entry of a message which is written into the display. The sequence remains in the display with the corresponding message. Continue with &m \$G.

.Stirrer: Switching stirrer on/off.

3.2.2.49.	Mode.Parameter.Presel.MeasMode	pH, U, Ipol, Upol, OFF
	Mode.Parameter.Presel.MeasInput	1, 2 , diff.
	Mode.Parameter.Presel.Ipol	0... 1 ...±127
	Mode.Parameter.Presel.Upol	0... 400 ...±1270
	Mode.Parameter.Presel.PolElectrTest	ON, OFF
	Mode.Parameter.Presel.Temp	-170... 25.0 ...500.0

Parameters for TIP: Selection of the measured quantity for manual measurements in the inactive state, see 3.2.2.2. Selection of the measuring input (MeasInput) applies to measured quantities pH and U. "diff." means differential amplifier, see page 159. With Ipol the requests for the polarization current in μA (Ipol) and .PolElectrTest apply. With Upol the request for the polarization voltage in mV (Upol) applies. Entry in steps of 10 mV. .PolElectrTest also applies. If the test for polarized electrodes is switched on (ON), it will be performed on the change from the inactive state to an active state. The temperature applies to pH measurements.

3.2.2.50. **UserMeth.FreeMem** read only
Memory space, available for user methods or silo lines. \$Q sends the number of free bytes, e.g.
"4928".

3.2.2.51.	UserMeth.Recall	\$G
	UserMeth.Recall.Name	up to 8 ASCII characters
	UserMeth.Store	\$G
	UserMeth.Store.Name	up to 8 ASCII characters
	UserMeth.Delete	\$G
	UserMeth.Delete.Name	up to 8 ASCII characters
	UserMeth.DelAll	\$G

Management of the internal method memory: Load, store and delete methods. An action is performed if "\$G" is sent to the corresponding node just after entering the name.

Do not use blank characters before and after method name!

.DelAll: Deletes all methods in the user memory.

3.2.2.52.	UserMeth.List.1.Name	read only
	UserMeth.List.1.Mode	read only
	UserMeth.List.1.Quantity	read only
	UserMeth.List.1.Bytes	read only
	UserMeth.List.1.Checksum	read only
		for each method

List of the methods in the user method memory with the following characteristics:

.Name: Name of the method

.Mode: Mode

.Quantity: Measured quantity

.Bytes: Number of bytes of the user memory used by the method

.Checksum: Checksum of the method, see 3.2.2.94.

- 3.2.2.53. MemoryCard.Recall** \$G
MemoryCard.Recall.Name up to 8 ASCII characters
MemoryCard.Store \$G
MemoryCard.Store.Name up to 8 ASCII characters
MemoryCard.Delete \$G
MemoryCard.Delete.Name up to 8 ASCII characters

Administration of the method memory of the current directory of the memory card: load, store and delete methods. The action is carried out, if "\$G" is transmitted to the corresponding node.

Do not use blank characters before and after method name!

- 3.2.2.54. MemoryCard.ChangeDir** \$G
MemoryCard.ChangeDir.Name up to 10 ASCII characters
MemoryCard.ChangeDir.Checksum \$G
MemoryCard.ChangeDir.Checksum.Value read only

Changing the current directory. The action is carried out if "\$G" is transmitted to the corresponding node.

Do not use blank characters before and after name!

The checksum characterizes the content of the directory.

- 3.2.2.55. MemoryCard.CreateDir** \$G
MemoryCard.CreateDir.Name up to 10 ASCII characters

Delete directory. The action is carried out if "\$G" is transmitted to the corresponding node.

Do not use blank characters before and after name!

- 3.2.2.56. MemoryCard.DeIDir** \$G
MemoryCard.DeIDir.Name up to 10 ASCII characters

Delete directory. The action is carried out if "\$G" is transmitted to the corresponding node.

Do not use blank characters before and after name!

- 3.2.2.57. MemoryCard.Backup** \$G
MemoryCard.Backup.Name up to 10 ASCII characters

Backup of the internal memory onto the card. The action is carried out if "\$G" is transmitted to the corresponding node.

Do not use blank characters before and after name!

- 3.2.2.58. MemoryCard.Reload** \$G
MemoryCard.Reload.Name up to 10 ASCII characters

Reload a backup from the memory card into the internal memory. The action is carried out if "\$G" is transmitted to the corresponding node.

Do not use blank characters before and after name!

- 3.2.2.59. MemoryCard.Format** \$G
MemoryCard.CardLabel.Name up to 8 ASCII characters

Format the memory card. The action is carried out if "\$G" is transmitted to the corresponding node.

Do not use blank characters before and after name!

3.2.2.60. MemoryCard.FreeMem read only
Free memory on the card. \$Q sends number of free bytes, e.g. "4928".

3.2.2.61. MemoryCard.BatteryChange \$G
MemoryCard.BatteryChange.Date YYYY-MM-DD
Date for changing battery. The date will be set with "\$G".

3.2.2.62. MemoryCard.List.Card.1.Name read only
MemoryCard.List.Card.1.Bytes read only
for each directory

List of all directories on the memory card with the following information:

.Name: Name of the directory

.Bytes: Number of bytes used by the directory

3.2.2.63. MemoryCard.List.ActDir.1.Name read only
MemoryCard.List.ActDir.1.Mode read only
MemoryCard.List.ActDir.1.Quantity read only
MemoryCard.List.ActDir.1.Bytes read only
MemoryCard.List.ActDir.1.Checksum read only
for each method

List of all methods of the current card directory with the following information:

.Name: Name of the method

.Mode: Mode

.Quantity: Measured quantity

.Bytes: Number of bytes used by the method

.Checksum: Checksum of the method, see 3.2.2.94.

3.2.2.64. Config.Monitoring.Validation.Status ON, OFF
Config.Monitoring.Validation.Interval 1...365...9999
Config.Monitoring.Validation.Counter 0...9999
Config.Monitoring.Validation.ClearCount \$G

Monitoring of validation.

.Interval: Time interval in days for validation.

.Counter: Time counter in days since last validation.

.ClearCount: Clears the above counter.

3.2.2.65. Config.Monitoring.Calibration.Status ON, OFF
Config.Monitoring.Calibration.MeasInput 1, 2, diff
Config.Monitoring.Calibration.Interval 1...7...9999
Config.Monitoring.Calibration.Counter 0...9999

Monitoring of pH calibration.

.MeasInput: Measuring input.

.Interval: Time interval in days for calibration from the last calibration date.

.Counter: Time counter in days since last calibration. The counter is reset to zero if a new calibration is carried out or if the calibration for the corresponding measuring input is entered manually.

3.2.2.66. Config.Monitoring.Service.Status ON, OFF
Config.Monitoring.Service.Date XXXX-XX-XX
 Monitoring of service interval.

3.2.2.67. Config.Monitoring.DiagRep ON, OFF
 Printing of system test report after each switching on of the Titrino.

3.2.2.68. Config.PeriphUnit.CharSet1 Epson, Seiko, Citizen, HP, IBM
Config.PeriphUnit.CharSet2
 Selection of the character set and the graphics control characters for COM1 resp. COM2 of the Titrino.
 IBM means the IBM character set following character set table 437 and IBM graphics control characters. Select 'IBM' for work with the computer.

3.2.2.69. Config.PeriphUnit.RepToComport 1, 2, 1&2
 Selection of COM of the Titrino where manually triggered reports should be outputted.

3.2.2.70. Config.PeriphUnit.Balance Sartorius, Mettler, Mettler AT, AND, Precisa
 Selection of the balance type.

3.2.2.71. Config.PeriphUnit.Stirrer ON, OFF
 Automatic stirrer control. With "ON" the stirrer will be switched on after starting a method. At the end of the method it is switched off again. Valid for DET, MET, SET.

3.2.2.72. Config.PeriphUnit.RemoteBox.Status ON, OFF
Config.PeriphUnit.RemoteBox.Keyboard US, deutsch, francais, español, schweiz.
Config.PeriphUnit.RemoteBox.Barcode input, method, id1, id2, id3, smpl size

Connections via Remote Box.

.Status: Select if a Remote Box is connected.

.Keyboard: Type of keyboard which is connected to the Remote Box.

.Barcode: Select target in Titrino where you wish to have the string from the barcode reader. "input" means that the string comes into the field where the cursor is currently placed.

3.2.2.73. Config.Aux.Language english, deutsch, francais, espanol, italiano, portugese, svenska

Selection of the dialog language.

3.2.2.74. Config.Aux.Set \$G
Config.Aux.Set.Date YYYY-MM-DD
Config.Aux.Set.Time HH:MM

Date and time.

Input format of the date: Year-month-day, two-digit, enter leading zeros.

Input format for the time: Hours:minutes, two-digit, enter leading zeros.

Date and time have to be set with &Config.Aux.Set \$G just after entry of the value.

3.2.2.75. Config.Aux.RunNo 0...9999
 Current sample number.
 Set to 0 on power on and initialization. After 9999, counting starts again at 0.

3.2.2.76. Config.Aux.AutoStart 1...9999, **OFF**
 Number of automatic, internal starts.

3.2.2.77. Config.Aux.StartDelay 0...999 999
 Start delay time in s. During this time, the data of the preceding determination are retained.

3.2.2.78. Config.Aux.ResDisplay **bold**, standard
 Character set for the result display at the end of the determination.

3.2.2.79. Config.Aux.DevName up to 8 ASCII characters
 Name of the instrument for connections with several units. It is advisable to use only the letters A...Z (ASCII No. 65...90), a...z (ASCII No. 97...122) and the numbers 0...9 (ASCII No. 48...57) when the function Setup.AutoInfo (3.2.2.125) is used at the same time.
 If a name has been entered, it will be printed out in the result report (full, short).

3.2.2.80. Config.Aux.Prog read only
 Output of the program version.
 The Titrimo sends "798.0010" on requests with \$Q.

3.2.2.81. Config.RSSet1 \$G
Config.RSSet1.Baud 300, 600, 1200, 2400, 4800, **9600**,
19200, 38400, 57600, 115200
Config.RSSet1.DataBit 7, **8**
Config.RSSet1.StopBit **1**, 2
Config.RSSet1.Parity even, odd, **none**
Config.RSSet1.Handsh **HWs**, SWchar, SWline, none

\$G sets all RS settings. The changes are performed only if the instrument is inactive. After the setting of the interface parameters, wait at least 2 s to allow the components to equilibrate.

Settings of the values for the data transmission via the RS interface: baud rate, data bit, stop bit, parity and type of handshake, see also page 126ff. Baud rates >9600 need a PC which is equipped accordingly (e.g. with 16550 component).

The setting of the values must be initiated with \$G immediately after entry of the values.

3.2.2.82. Config.ComVar.C30 0... ±999 999
with up to **.C39**, etc.

Values of the common variables from C30 up to C39. Insert the common variables directly or describe the determination results directly from the method, see 3.2.2.7

3.2.2.83. SmpIData.Status ON, OFF

On/off switching of silo memory. When the silo memory is switched on, the sample data are fetched from the lowest valid silo line.

3.2.2.84. SmpIData.OFFSilo.Id1 up to 8 ASCII characters
SmpIData.OFFSilo.Id2 up to 8 ASCII characters
SmpIData.OFFSilo.Id3 up to 8 ASCII characters
SmpIData.OFFSilo.ValSmpl 6-digits, sign and decimal point
SmpIData.OFFSilo.UnitSmpl up to 5 ASCII characters

Current sample data.

The identifications Id1...Id3 can be used in formulas as sample-specific calculation constants C21...C23.

If "no unit" is desired for the unit of the sample size, the blank string must be entered.

3.2.2.85. SmpIData.ONSil.Counter.MaxLines read only
SmpIData.ONSil.Counter.FirstLine read only
SmpIData.ONSil.Counter.LastLine read only

Information on silo memory.

.MaxLines: Maximum possible number of silo lines.

.FirstLine: Lowest valid silo line.

.LastLine: Last occupied silo line.

3.2.2.86. SmpIData.ONSil.EditLine.1.Method up to 8 ASCII characters
SmpIData.ONSil.EditLine.1.Id1 up to 8 ASCII characters
SmpIData.ONSil.EditLine.1.Id2 up to 8 ASCII characters
SmpIData.ONSil.EditLine.1.Id3 up to 8 ASCII characters
SmpIData.ONSil.EditLine.1.ValSmpl 6-digits, sign and dec.point
SmpIData.ONSil.EditLine.1.UnitSmpl up to 5 ASCII characters
SmpIData.ONSil.EditLine.1.C24 read only
SmpIData.ONSil.EditLine.1.C25 read only
SmpIData.ONSil.EditLine.1.Mark read only
etc., up to **.255**

Contents of a silo line.

- .Method: Method used to process the sample, from the method memory or from the card.
- .Id: The identifications Id1...Id3 can also be used as sample-specific calculation constants C21...C23 in formulas.
- .UnitSmpl: If "no unit" is desired for the sample size, the blank string must be entered.
- .C24, .C25: Results which have been assigned to C24 and C25.
- .Mark: Mark of the silo line: "*" = deleted line, "+" = line which is worked off, "-" = line which is worked off and not valid for silo calculations (deleted), "/" = last worked-off line, where recalculation can still be done. Silo lines which have been worked off are "read only".

3.2.2.87. SmpIData.ONSilO.DelLine \$G
SmpIData.ONSilO.DelLine.LineNum 1...255, OFF

Deletion of a silo line. The line # is deleted with &SmpIData.ONSilO.DelLine \$G. If a formerly deleted line is edited again, it becomes valid (function "undelete").

3.2.2.88. SmpIData.ONSilO.DeIAll \$G

Deletes the entire silo memory. Must be triggered with \$G.

3.2.2.89. SmpIData.ONSilO.CycleLines ON, OFF

Silo data cycling.

With "ON", executed lines are copied to the next free silo lines, see page 62.

Exercise caution if you edit the silo memory during the determinations!

3.2.2.90. SmpIData.ONSilO.SaveLines ON, OFF

Silo lines are not deleted when they are worked off. Assigned results are stored as C24 and C25. "Save lines" can only be set to "ON" if the silo is completely empty. Delete the silo, see 3.2.2.88.

3.2.2.91. HotKey.User.Name up to 10 ASCII characters
HotKey.User.Delete \$G
HotKey.User.Delete.Name up to 10 ASCII characters
HotKey.User.DeIAll \$G
HotKey.User.List.1.Name read only

Management of user names.

.Name: Input of user names.

.Delete.Name: Deletes selected user name with &HotKey.User.Delete \$G.

.List: List of all user names.

3.2.2.92. Info.Report \$G

Info.Report.Select configuration, parameters, smpI data, statistics, silo, calib, C-fmla, def, user method, full,

short, mplist, curve, deriv, comb, adj para, scalc full, scalc srt, calc, act dir, mem card, all, ff

\$G sends the selected report to the COM which is set in &Config.PeriphUnit.RepToComport:

configuration: Configuration report. Is not accessible during a running determination.

parameters: Parameter report of the current method. During a running determination only "live"-parameters are accessible.

smpl data: Current sample data.

statistics: Statistics table with the individual results.

silo: Contents of the silo memory.

calib: Calibration data of the measuring input in the current method.

C-fmla: Contents of the <C-fmla> key.

def: Contents of the <def> key.

user method: Contents of the method memory.

full: Full result report of the last completed determination.

short: Short result report of the last completed determination.

mplist: Measuring point list of the running determination.

curve: Titration curve of the last determination.

derive: 1st derive of titration curve of the last determination (with DET).

comb: 1st derive combined with the titration curve of the last determination (with DET).

adj para: Adjustment parameters.

scalc full: Full report of the silo calculations.

scalc srt: Short report of the silo calculations.

calc: Calculation report of the current method.

act dir: Methods of the current directory of the memory card.

mem card: All methods of the memory card.

all: All reports.

ff: Form feed on printer.

Reports which are sent from the Titrimo are marked with space (ASCII 32) and ' at the beginning. Then an individual identifier for each report follows. Reports which are triggered by RS232 (\$G) have the same introducer but without preceding space, i.e. they start with '.

3.2.2.93. Info.CalibrationData \$G

Info.CalibrationData.Inp1.pHas	-20.00... 7.00 ...+20.00
Info.CalibrationData.Inp1.Slope	-9.999... 1.000 ...+9.999
Info.CalibrationData.Inp1.Temp	-170.0... 25.0 ...+500.0
Info.CalibrationData.Inp1.Date	read only
Info.CalibrationData.Inp1.ElectrodeId	read only

identical for .Inp2 and .Diff

pH calibration data for measuring input 1. After the calibration, the data are entered automatically together with the date of the calibration and the electrode identification, see 3.2.2.44.

Calibration data can be entered. They are accepted with &Info.CalibrationData \$G. If calibration data are entered, the calibration date is deleted.

3.2.2.94. Info.Checksums \$G

Info.Checksums.MPList	read only
Info.Checksums.ActualMethod	read only

The checksums can be used to identify the content of a file unequivocally, e.g. files with identical content have identical results of the checksums. An empty file has checksum "0". The calculation of the checksums is triggered with \$G.

.MPList: Result of the checksum of the current measuring point list.
.ActualMethod: Result of the checksum of the current method in the working memory. Identical methods with different method names have the same results of the checksum.

3.2.2.95. **Info.DetermData** \$G
Info.DetermData.Write ON, OFF
Info.DetermData.MPList.1.Attribute read only/read + write
Info.DetermData.ExV read only/read + write
Info.DetermData.MPList.1.X read only/read + write
Info.DetermData.MPList.1.Y read only/read + write
Info.DetermData.MPList.1.Z1 read only/read + write
Info.DetermData.MPList.1.Z2 read only/read + write
for every measuring point

Determination data in hexadecimal format. A measuring point list is available in mode DET, MET, SET, and MEAS.

Recalculation of the measuring data is triggered with \$G.

.Write: With "ON", the following nodes can be overwritten:
&Info.DetermData.MP.List, &Info.TitrResults.Var.C4X (X = 0...5),
&Info.TitrResults.TempVar.C7X (X = 0...9), and &Mode.Name.

.ExV: Volume of the exchange unit, with which the determination was executed

.MPList.1.Attribute: Attribute

.MPList.X: X coordinate, time

.MPList.Y: Y coordinate, volume

.MPList.Z1: Z1 coordinate, measuring value

.MPList.Z2: Z2 coordinate, temperature

3.2.2.96. **Info.TitrResults.RS.1.Value** read only
etc., up to **.9**
Info.TitrResults.EP.1.V read only
Info.TitrResults.EP.1.Meas read only
etc., up to **.2**
Info.TitrResults.Var.C40 read only/read + write
etc., up to **.C47**
Info.TitrResults.Var.DTime read only/read + write

.RS: Values of the calculated results.

.EP: Endpoints with DET, MET, SET:

Volume coordinate in mL, e.g. "1.2340"

Measured value coordinate in pH "5.12", mV (with U and Ipol) "-241" or μ A (with Upol) "43.7".

.Var: Various variables. You may overwrite the variables C40...C45, see 3.2.2.95.

C40: Initial measured value in pH "5.12", mV (with U and Ipol) "41", μ A (with Upol) "43.7" or °C (with T) "25.0". In MEAS final measured value.

C41: End volume with SET in ml, "12.5360".

C42: Time from start of titration to end in s, "62".
 C43: Volume drift on start of a SET titration from the conditioning in ul/min, "3.5".
 C44: (Last measured) temperature in °C. Used for the temperature compensation in pH measurements.
 C45: Start volume with DET, MET, SET in ml, "2.800".
 C46: Asymmetry pH of CAL, "6.89".
 C47: Relative electrode slope of CAL, "0.9950".
 C48: Voltage at maximum voltage (not valid in CAL and TIP)
 C49: Voltage at minimum voltage (not valid in CAL and TIP)
 DTime: Time in s for the drift correction in SET with conditioning.

3.2.2.97. **Info.TitrResults.FixEP.51.Value** read only
 etc. up to **.59**
Info.TitrResults.pK.61.Value read only
 etc. up to **.69**
Info.TitrResults.TempVar.C70 read only/read + write
 etc. up to **.C79**

.FixEP: Fix EP with DET, MET. C5X corresponds to X = 1...9.

.pK: With DET, MET. C6X corresponds to X = 1...9.

.TempVar: Temporary variables in TIP corresponding to the assignments in the submethods.

3.2.2.98. **Info.StatisticsVal.ActN** read only
Info.Statistics.1.Mean read only
Info.Statistics.1.Std read only
Info.Statistics.1.RelStd read only
 etc. up to **.9**

The current values of the statistics calculation.

\$Q sends, e.g.

ActN: Current value of the individual results "3"

Data for MN1:

Mean: Mean value (decimal places as in result) "3.421"

Std: Standard deviation (1 decimal place more than in result) "0.0231"

RelStd: Relative standard deviation (in %, 2 decimal places) "0.14"

3.2.2.99. **Info.SiloCalc.C24.Name** read only
Info.SiloCalc.C24.Value read only
Info.SiloCalc.C24.Unit read only
 for **.C25** as for **.C24**
Info.SiloCalc.C26.ActN read only
Info.SiloCalc.C26.Mean read only
Info.SiloCalc.C26.Std read only
Info.SiloCalc.C26.RelStd read only
 for **.C27** as for **.C26**

The current values from the silo calculations. C26 is the mean value out of the C24 variables; C27 comes from C25.

\$Q sends:

C24.Name: Name of the assigned value "RS1"

C24.Value: Value "2.222"

C24.Unit: Unit of the assigned value	"%"
C26.ActN: Number of single results	"3"
C26.Mean: Mean (decimal places as for the result itself)	"3.421"
C26.Std: Standard deviation (decimal places as for the result + 1)	"0.0231"
C26.RelStd: Relative standard deviation (in %, 2 decimal places)	"0.14"

3.2.2.100. Info.ActualInfo.Inputs.Status	read only
Info.ActualInfo.Inputs.Change	read only
Info.ActualInfo.Inputs.Clear	\$G
Info.ActualInfo.Outputs.Status	read only
Info.ActualInfo.Outputs.Change	read only
Info.ActualInfo.Outputs.Clear	\$G

Status sends the current status of the I/O lines, Change sends the information regarding whether a change in status of a line has taken place since the last clearing, Clear clears the change information. For the output, there is a conversion from binary to decimal, e.g.

	0 0 0 0 0 0 0 0 0 0 1 0 1 0
Line No.	13 12 11 10 9 8 7 6 5 4 3 2 1 0
Output:	$2^1 + 2^3 = "10"$

1 means ON or change; 0 means OFF or no change.

The lines are assigned as follows (see also pages 165ff):

Inputs:		Outputs:	
0	Start (pin 21)	0	Ready (pin 5)
1	Stop (pin 9)	1	Cond. ok (pin 18)
2	Enter (pin 22)	2	Titration (pin 4)
3	Clear (pin 10)	3	EOD (pin 17)
4	Smpl Ready (pin 23)	4	L4 in TIP (pin 3)
5	pin 11	5	Error (pin 16)
6	pin 24	6	Activate, L6 in TIP (pin 1)
7	pin 12	7	Pulse for recorder (pin 2)
		8	not used (pin 6)
		9	not used (pin 7)
		10	not used (pin 8)
		11	not used (pin 13)
		12	Smpl size out (pin 19)
		13	Result out (pin 20)

3.2.2.101. Info.ActualInfo.Assembly.CyclNo read only
 \$Q sends the current cycle number of the voltage measurement cycle, e.g. "127". From the cycle number and the cycle time (see 3.2.2.108), a time frame can be set up.

The cycle number is set to 0 on switching on the instrument, on every start and for QuickMeas. It is incremented as long as the instrument remains switched on.

3.2.2.102. Info.ActualInfo.Assembly.Counter.V read only
Info.ActualInfo.Assembly.Counter.Clear \$G
 \$Q sends the volume. With the function &Info.Assembly.Counter.Clear \$G, the volume counter is set to zero.

3.2.2.103. Info.ActualInfo.Assembly.Meas read only
 \$Q sends the current measured value from the assembly.

3.2.2.104. Info.ActualInfo.Titrator.CyclNo read only
Info.ActualInfo.Titrator.V read only
Info.ActualInfo.Titrator.Meas read only
Info.ActualInfo.Titrator.dVdt read only
Info.ActualInfo.Titrator.dMeasdt read only
Info.ActualInfo.Titrator.dMeasdV read only
Info.ActualInfo.Titrator.ERC read only
Info.ActualInfo.Titrator.T read only

\$Q sends the current values in the following formats:

	DET	MET	SET	MEAS	CAL
CyclNo	127	127	127	127	127
V(ml)	1.2345	1.2345	1.2345	-	-
Meas:					
pH	3.345	3.345	3.6(mV)	3.345	3.345
U, Ipol (mV)	-345.6	-345.6	-345.6	-345.6	-
Upol (uA)	-12.5	-12.5	-12.5	-12.5	-
T (°C)	-	-	-	25.0	-
dVdt (ul/s)	-	-	2.5142	-	-
dMeasdt					
pH,U,Ipol mV/s	0.7957	0.7957	0.7957	0.7957	0.7957
Upol (uA/s)	0.7957	0.7957	0.7957	0.7957	-
T (°C/s)	-	-	-	0.7957	-
dMeasdV (mV/ul)	-	-	10.6326	-	-
ERC	34	-	-	-	-
T (°C)	25.9	25.9	-	25.9	-

NV: Not Valid. If in the signal drift is OFF in modes MEAS and CAL, the signal drift is NV.

OV will be sent for "overrange".

A time frame can be set up from the cycle number and the cycle time (see 3.2.2.108). The cycle number is set to 0 at the start of a method and it is incremented until the end of the method.

3.2.2.105. Info.ActualInfo.MeasPt.Index read only
Info.ActualInfo.MeasPt.X read only
Info.ActualInfo.MeasPt.Y read only
Info.ActualInfo.MeasPt.Z1 read only
Info.ActualInfo.MeasPt.Z2 read only
Info.ActualInfo.EP.Index read only
Info.ActualInfo.EP.X read only
Info.ActualInfo.EP.Y read only

\$Q sends the last entry into the measuring point list (.MeasPt) or the last entry into the list of EP's with DET, MET, SET.

.MeasPt.X"165" Volume (DET, MET), time (SET), resp. of the MPList in s

.MeasPt.Y"3.654" Measured value (DET, MET), volume (SET), resp. of the MPList in mL

.MeasPt.Z1"6.34" Measured value (SET, MEAS) of the MPList, format depends on the measured quantity

.MeasPt.Z2"25.8" Temperature of the MPList in °C

.EP.X"1.234" Volume coordinate of the EP

.EP.Y"5.34" Measured value coordinate of the EP

3.2.2.106. **Info.ActualInfo.Display.L1** up to 32 ASCII characters
Info.ActualInfo.Display.L8 up to 32 ASCII characters
Info.ActualInfo.Display.DelAll \$G

Lines of the display. The display can be written to from the computer. Proceed as follows:

1. Lock the display, see 3.2.2.119.
2. Delete the whole display (.DelAll).
3. For writing onto the display, the standard character set will be used.
4. Unlock the display, see 3.2.2.119
5. Delete the whole display (.DelAll).
6. Send a value to nod &Config.Aux.ResDisplay (see 3.2.2.78) to refresh the display.

\$Q sends the contents of the corresponding display line.

3.2.2.107. **Info.ActualInfo.Comport.Number** read only
 \$Q sends the comport number of the Titrimo where the PC is connected.

3.2.2.108. **Info.Assembly.CycleTime** read only
Info.Assembly.ExV read only

Inquiries regarding basic variables of the assembly: Cycle time in s, volume of the active Exchange Unit in mL.

3.2.2.109. **Assembly.Bur.Rates.Forward.Selected** digital, **analog**
Assembly.Bur.Rates.Forward.Digital 0...150, **max.**
Assembly.Bur.Rates.Reverse.Selected digital, **analog**
Assembly.Bur.Rates.Reverse.Digital 0...150, **max.**

Expel and aspirating rate.

Digital or analog control. With digital control, the inputted value applies (in mL/min). "max." means maximum possible rate with the Exchange Unit in current use.

Analog means rate control with the analog potentiometer on Titrimo.

3.2.2.110. **Assembly.Bur.Fill** \$G, \$H, \$C
 \$G starts the 'FILL' mode of the buret function.

3.2.2.111. **Assembly.Bur.ModeDis** \$G, \$\$, \$H, \$C
Assembly.Bur.ModeDis.Selected **volume**, time
Assembly.Bur.ModeDis.V 0.0001...**0.1**...9999
Assembly.Bur.ModeDis.Time 0.25...**1**...86400
Assembly.Bur.ModeDis.VStop 0.0001...9999, **OFF**
Assembly.Bur.ModeDis.AutoFill **ON, OFF**

Dispensing mode with parameters. The dispensing mode can only be started and stopped via the RS Control. During a running dosification, no method can be started at the Titrino.

- .Selected: Dispensing of volume increments or during a preset time.
- .Volume, .Time: Size of the volume increments or entry of time.
- .VStop: Limit volume for the dispensing.
- .AutoFill: ON means automatic filling after every dispensing.

3.2.2.112. Assembly.Meas.Status	ON, OFF
Assembly.Meas.MeasInput	1, 2, Diff., Ipol, Upol, Temp
Assembly.Meas.Ipol	±127...1...+127
Assembly.Meas.Upol	±1270...400...+1270

Measurement in assembly. The measuring function can only be started via RS Control. When the measuring function is switched on, no method can be started at the Titrino.

- .Input: Selection of the potentiometric measuring input 1, 2, diff., polarized electrodes or temperature.
- .Ipol: Polarization current in μA .
- .Upol: Polarization potential in mV, entry in steps of 10 mV.

3.2.2.113. Assembly.Outputs.AutoEOD	ON, OFF
Assembly.Outputs.SetLines	\$G
Assembly.Outputs.SetLines.L0 up to .L13	active, inactive, pulse, OFF
Assembly.Outputs.ResetLines	\$G

Setting the I/O output lines.

.AutoEOD: The automatic output of the EOD (End of Determination) at the end of the determination can be switched off. Thus, for example, in conjunction with a Titrino several determinations can be performed in the same beaker. Before AutoEOD is switched on, line 3 must be set to "OFF".

.SetLines: With \$G, all lines are set.

.SetLines.LX: Set the line LX. "active" means setting of a static signal, "inactive" means resetting of the signal, "pulse" means output of a pulse of app. 150 ms, "OFF" means the line is not operated, see also page 167.

Warnings:

- If you have "AutoEOD" to "ON", an active line 3 is set to "inactive" by the EOD pulse.
- L6 is the line of the activate pulse. An active line 6 is set to "inactive" by the activate pulse.
- L5 is the error line. It is continuously controlled by the Titrino program and can therefore not be set freely.

Line assignments in Titrino program:

L0	Ready, inactive state
L1	Conditioning OK
L2	Titration in progress
L3	EOD (End Of Determination)
L4	Can be set in TIP
L5	Error

L6	Activate pulse + can be set in TIP
L7	Buret volume pulses
L8	Remote box active
L12	Sample size out of limits
L13	Result out of limits

.ResetLines: Lines are set to the inactive status (= high).

3.2.2.114. Assembly.Stirrer ON, OFF
Switching stirrer ON/OFF.

3.2.2.115. Setup.Comport 1, 2, 1&2
Selects the Titrino COM for the output of automatic info:
&Setup.Keycode
&Setup.Trace
&Setup.SendMeas
&Setup.AutoInfo

3.2.2.116. Setup.Keycode ON, OFF
ON means the key code of a key pressed on the Titrino is outputted. The key code comprises 2 ASCII characters; table of the keys with their code, see page 140. A keystroke of key 11 is sent as follows:
#11
The beginning of the message is marked by a space (ASCII 32).

3.2.2.117. Setup.Tree.Short ON, OFF
Setup.Tree.ChangedOnly ON, OFF
Definition of the type of answer to \$Q.
.Short: With "ON", each path is sent with only the necessary amount of characters in order to be unequivocal (printed in bold in this manual). A combination of .Short and .ChangedOnly is not possible.
.ChangedOnly: Sends only the changed values, i.e. values which have been edited. All paths are sent absolute, i.e. from the root.

3.2.2.118. Setup.Trace ON, OFF
The Titrino automatically reports when a value has been confirmed with <enter> at the Titrino. Message, e.g.:
&Smpldata.OFFSilo.Id1"Trace"
The beginning of the message is marked by a space (ASCII 32).

3.2.2.119. Setup.Lock.Keyboard ON, OFF
Setup.Lock.Config ON, OFF
Setup.Lock.Parameter ON, OFF
Setup.Lock.Smpldata ON, OFF
Setup.Lock.UserMeth.Recall ON, OFF
Setup.Lock.UserMeth.Store ON, OFF
Setup.Lock.UserMeth.Delete ON, OFF

Setup.Lock.Display **ON, OFF**

ON means disable the corresponding function:

- .Keyboard: Disable all keys of the Titrinos
- .Config: Disable the <configuration> key
- .Parameter: Disable the <parameter> key
- .SmplData: Disable the <smpl data> key
- .UserMeth.Recall: Disable "recall" in <user meth> key
- .UserMeth.Store: Disable "store" in <user meth> key
- .UserMeth.Delete: Disable "delete" in <user meth> key
- .Display: Disable the display, i.e. it will not be written to by the device program of the Titrino and can be operated from the computer.

3.2.2.120. Setup.Mode.StartWait **ON, OFF**
Setup.Mode.FinWait **ON, OFF**

Holding points in the method sequence. If they are "ON", the sequence stops until "OFF" is sent. Switching the instrument on sets both nodes to OFF:

- .StartWait: Holding point right after starting a method or submethod in TIP (holding point after AutoInfo !" .T.GC").
- .FinWait: Holding point at the end a method or submethod in TIP (holding point after AutoInfo !" .T.F").

3.2.2.121. Setup.SendMeas.SendStatus **ON, OFF**
Setup.SendMeas.Interval 0.08...4...16200, MPLList

- .SendStatus: ON means the automatic transmission of measured values (see 3.2.2.123 and 3.2.2.124) in the inputted interval is active.
- .Interval: Time interval (in s) for the automatic transmission of associated measured values defined under points 3.2.2.123 and 3.2.2.124. The inputted value is rounded off to a multiple of 0.08. The smallest possible time interval depends on the number of measured values which have to be sent, on the baud rate, on the load on the interface and on the type of device connection. With "MPLList" the measured values are sent at the time of their entry into the measured point list.

The automatic transmission is switched on/off with 'SendStatus'.

3.2.2.122. Setup.SendMeas.Select Assembly, **Titration**
 Selection of the unit of which the measured values should be sent (3.2.2.123 or 3.2.2.124).

3.2.2.123. Setup.SendMeas.Assembly.CyclNo **ON, OFF**
Setup.SendMeas.Assembly.V **ON, OFF**
Setup.SendMeas.Assembly.Meas **ON, OFF**

Selection of the values from Assembly for the output in the set time interval (see 3.2.2.121):

- .CyclNo: Cycle number of the potential measurement. Together with the cycle time (3.2.2.108), a time frame can be set up. The cycle number is set to 0 on switching on the instrument and it is always incremented as long as the instrument remains switched on.

.V: Volume
 .Meas: Measured value associated to the cycle number.
 The unit "assembly" must be preset (see 3.2.2.122).

3.2.2.124. Setup.SendMeas.Titrator.CyclNo ON, OFF
Setup.SendMeas.Titrator.V ON, OFF
Setup.SendMeas.Titrator.Meas ON, OFF
Setup.SendMeas.Titrator.dVdt ON, OFF
Setup.SendMeas.Titrator.dMeasdt ON, OFF
Setup.SendMeas.Titrator.dMeasdV ON, OFF
Setup.SendMeas.Titrator.ERC ON, OFF
Setup.SendMeas.Titrator.T ON, OFF

Selection of the values from the titrator which are sent in the set time interval (see 3.2.2.121, formats see 3.2.2.104):

.CyclNo: Cycle number. Together with the cycle time (3.2.2.108), a time frame can be set up. The other data belong to the corresponding cycle number. The cycle number is set to 0 at the start of a method and it is incremented until the end of the method.

.V: Volume.
 .Meas: Measuring value
 .dVdt: associated volume drift.
 .dMeasdt: associated measured value drift.
 .dMeasdV: associated 1st derivative of the titration curve.
 .ERC: ERC in DET.
 .T: Temperature.

The unit "titrator" must be preset (see 3.2.2.122).

3.2.2.125. Setup.AutoInfo.Status ON, OFF
Setup.AutoInfo.P ON, OFF
Setup.AutoInfo.T.R ON, OFF
Setup.AutoInfo.T.G ON, OFF
Setup.AutoInfo.T.GC ON, OFF
Setup.AutoInfo.T.S ON, OFF
Setup.AutoInfo.T.B ON, OFF
Setup.AutoInfo.T.F ON, OFF
Setup.AutoInfo.T.E ON, OFF
Setup.AutoInfo.T.H ON, OFF
Setup.AutoInfo.T.C ON, OFF
Setup.AutoInfo.T.O ON, OFF
Setup.AutoInfo.T.N ON, OFF
Setup.AutoInfo.T.Re ON, OFF
Setup.AutoInfo.T.Si ON, OFF
Setup.AutoInfo.T.M ON, OFF
Setup.AutoInfo.T.EP ON, OFF
Setup.AutoInfo.T.RC ON, OFF
Setup.AutoInfo.C.B1 ON, OFF
Setup.AutoInfo.C.R1 ON, OFF
Setup.AutoInfo.C.B2 ON, OFF
Setup.AutoInfo.C.R2 ON, OFF
Setup.AutoInfo.I ON, OFF
Setup.AutoInfo.O ON, OFF

ON means that the Titrino reports automatically the moment the corresponding change occurs.

.Status: Global switch for all set AutoInfo.

.P PowerOn: Simulation of power on (3.2.2.127). Not from mains.

Messages from node .T, Titrator:

.T.R Ready: Status 'Ready' has been reached.

.T.G Go: Instrument has been started.

.T.GC GoCommand: Instrument (or submethod in TIP) has received a go command.

.T.S Stop: Status 'Stop' has been reached.

.T.B Begin of sequence (or submethod).

.T.F Final: End of determination (or submethod), the final steps will be carried out.

.T.E Error. Message together with error number, see page 73ff.

.T.H Hold: Status 'Hold' has been reached.

.T.C Continue: Continue after hold.

.T.O Conditioning OK: EP reached (in SET with conditioning).

.T.N Conditioning Not OK: EP not reached (in SET with conditioning).

.T.Re Request: In the inquiry of an identification or the sample size after start of titration.

.T.Si SiloEmpty: Silo empty, i.e. the last line has been removed from the silo memory.

.T.M MeasList: Entry in the measuring point list (with DET, MET, SET, MEAS).

.T.EP EPList: Entry into EP list (with DET, MET, SET)

.T.RC Results have been recalculated.

Messages from node .C, Comport:

.C.B1 COM1: A report is outputted on COM1. During this time, COM2 will be blocked. COM2 is generally blocked, if COM1 is busy.

.C.R1 COM1 is ready again. (Comes also when you <QUIT> an error.)

.C.B2, .R2 Identical for COM2.

Messages for changings in the I/O lines. If the changings are made simultaneously, there is 1 message. Pulses receive 2 messages: one message each for line active and inactive.

.I Input: Change of an input line.

.O Output: Change of an output line (except 7, pin 2, for recorder pulses).

If a change occurs that requires a message, the Titrino sends space (ASCII 32) and ! as an introducer. This is followed by the name of the device (see 3.2.2.79). Special ASCII characters in the device name are ignored. If no device name has been entered, only ! is sent. Finally the Titrino sends the information which node has triggered the message.

Example: !John".T.Si": The message was triggered from instrument "John", node .T.Si

3.2.2.126. Setup.Graphics.Grid	ON, OFF
Setup.Graphics.Frame	ON, OFF
Setup.Graphics.Scale	Full, Auto
Setup.Graphics.Recorder.Right	0.2... 0.5 ...1.00
Setup.Graphics.Recorder.Feed	0.01... 0.05 ...1.00

Change in the appearance and the format of the curve for the output. The settings are valid for both Titrino COM ports.

- .Grid: On/off switching of grid over curve.
- .Frame: On/off switching of frame surrounding the curve. If grid and frame are switched off, the curve is printed faster as the print head does not have to move to the end of the paper.
- .Scale: Type of scaling of the measured value axis: Full means that the scale runs from the smallest up to the greatest measured point. With auto, the smallest measured value is taken and the next smaller tick defines the beginning of the scale; the next greater tick to the greatest measured value is the end of the scale.
- .Right: Relative specification of the width of the output medium (e.g. paper width) for the length of the measured value axis. 1 means the measured value axis is plotted over the entire width of the paper (largest possible width). In extreme cases, the writing of the right tick may lie outside.
- .Feed: Length of the volume axis referred to the buret cylinder volume, V(B) per cm (0.1 means, e.g. 1 mL/cm with a 10 mL Exchange Unit). Depending on the printer, the measure in cm may not always be correct.

3.2.2.127. Setup.PowerOn \$G
Simulation of 'power on'. The device has the same status as after power on: The cylinder is filled, error messages deleted and the current sample number set to 0. The method last used is ready for operation.

3.2.2.128. Setup.Initialise \$G
Setup.Initialise.Select **ActMeth**, Silo, Calib, Config, Assembly, Setup, All

Setting of default values for the following areas:

ActMeth: Current method. Parameters, calculations, and assignments for the data output, operands C01...C19.

Silo: The silo memory is deleted. Same function as delete entire silo.

Calib: pH calibration data for all measuring inputs.

Config: All values under &Config.

Assembly: All values under &Assembly.

Setup: All values under &Setup.

All: Values of the entire tree (except silo and method memory).

The action must be triggered with &Setup.Initalise \$G.

3.2.2.129. Setup.RamInit \$G
Initializes instrument, see page 148. All parameters are set to their default value and error messages are cleared. The user and silo memories will be deleted. The user memory contains the default user methods from Metrohm.

3.2.2.130. Setup.InstrNo \$G
Setup.InstrNo.Value **serial number**, 8 ASCII characters
Instrument identification for report output.
Set the value with &Setup.InstrNo \$G .

3.2.2.131. Diagnose.Report

\$G

Output of the report containing the adjustment parameters. The Titrino has to be in its inactive basic state.

3.3 Properties of the RS 232 Interface

Data Transfer Protocol

The Titrino is configured as DTE (Data Terminal Equipment).

The RS 232 interface has the following technical specifications:

- Data interface according to the RS 232C standard, adjustable transfer parameters, see page 10.
- Max. line length: 512 characters
- Control characters: C_R (ASCII DEC 13)
L_F (ASCII DEC 10)
XON (ASCII DEC 17)
XOFF (ASCII DEC 19)
- Cable length: max. approx. 15 m

Start	7 or 8 Data Bit	Parity Bit	1 or 2 Stop Bit
-------	-----------------	------------	-----------------

Only a shielded data cable (for example, METROHM D.104.0201) may be used to couple the Titrino with foreign devices. The cable shield must be properly grounded on both instruments (pay attention to current loops; always ground in a star-head formation). Only plugs with sufficient shielding may be used (for example, METROHM K.210.0381 with K.210.9045).

3.3.1 Handshake

Software-Handshake, SWchar

Handshake inputs on the Titrino (CTS) are not checked.
Handshake outputs (DTR, RTS) are set by the Titrino.
The Titrino sends XOFF when its input buffer contains 384 characters. After this it can receive 128 extra characters (including L_F).

Titrino as Receiver :

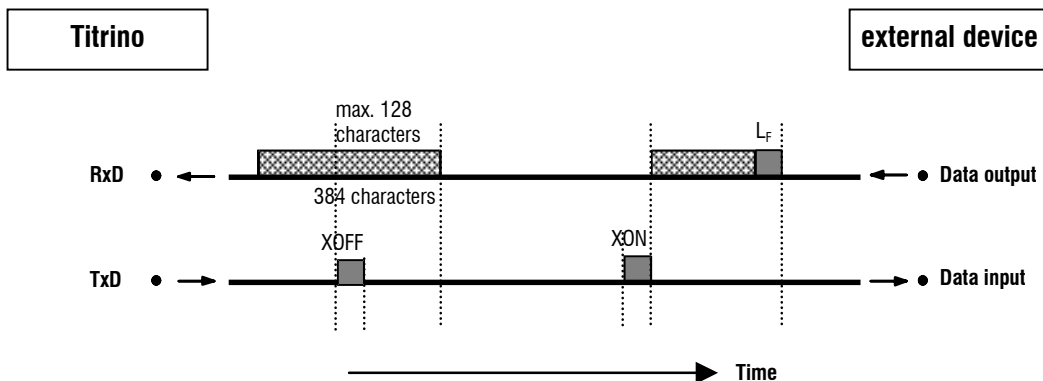

Titrimo as Sender :

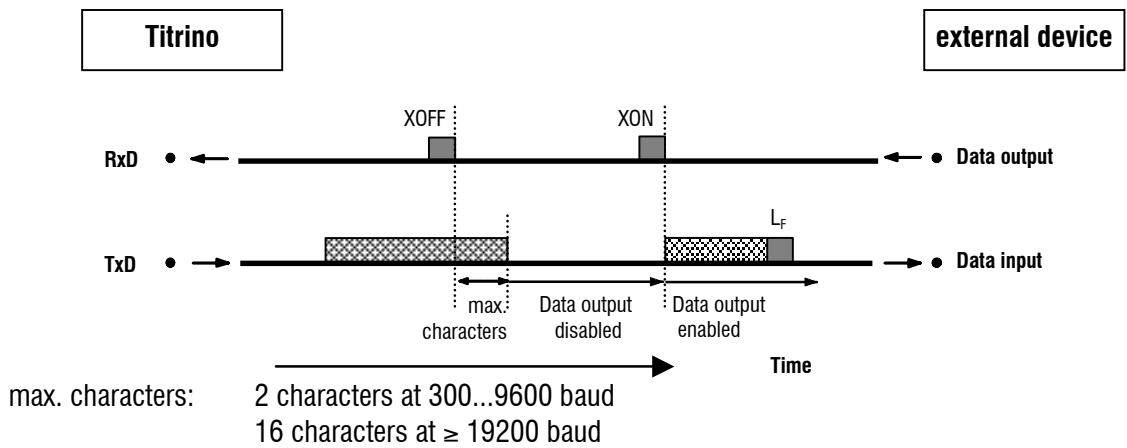

Software-Handshake, SWline

Handshake input ports on the Titrimo (CTS) are not checked.
Handshake output ports (DTR, RTS) are set by the Titrimo.
The Titrimo has an input buffer which can accept up to 512 characters.

Titrimo as Receiver :

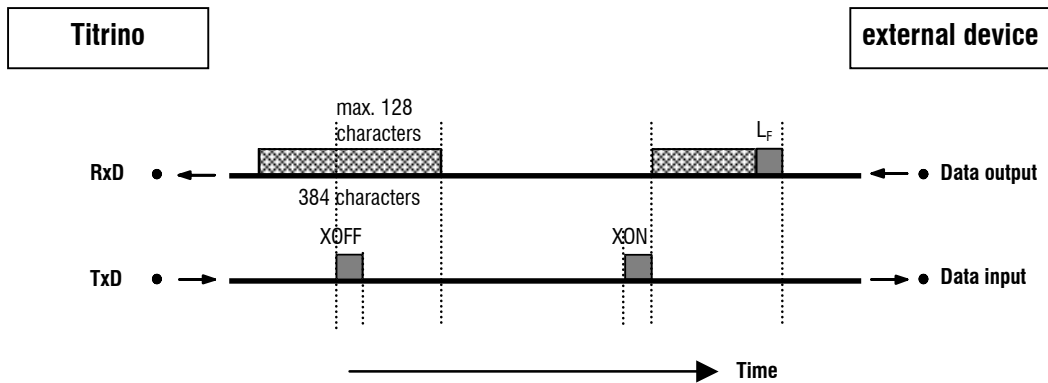

Titrimo as Sender:

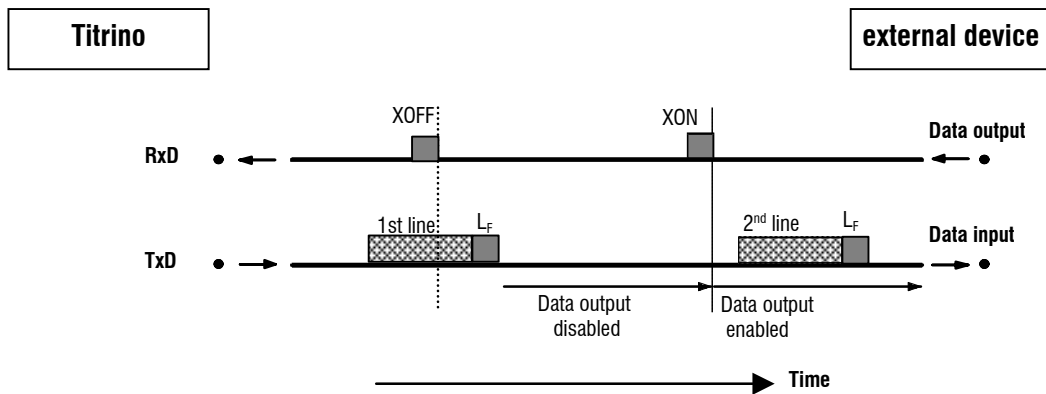

Titrimo transmission can be stopped by external instruments with XOFF. After XOFF is received the Titrimo completes sending the line already started. If data output is disabled for more than 6 s by XOFF, E43 appears in the display.

Hardware-Handshake, HWs

Titrimo as Receiver :

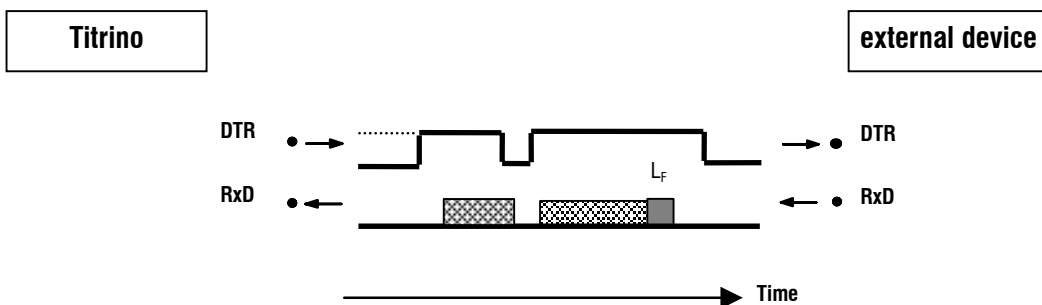

Titrimo as Sender:

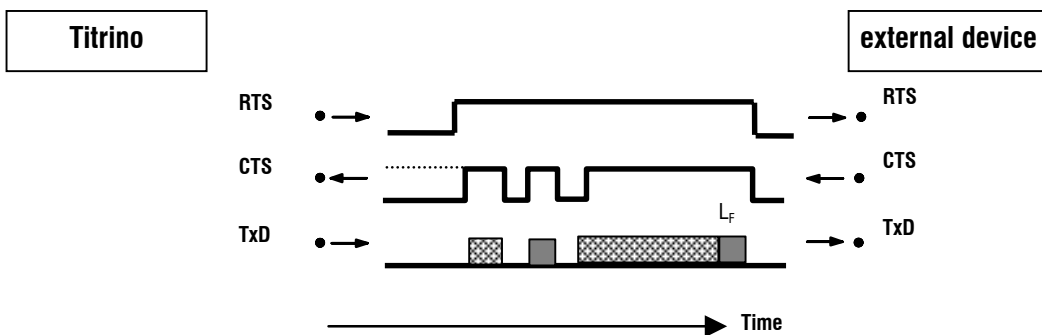

The data flow can be interrupted by deactivating the CTS line.

3.3.2 Pin Assignment

RS232C Interface

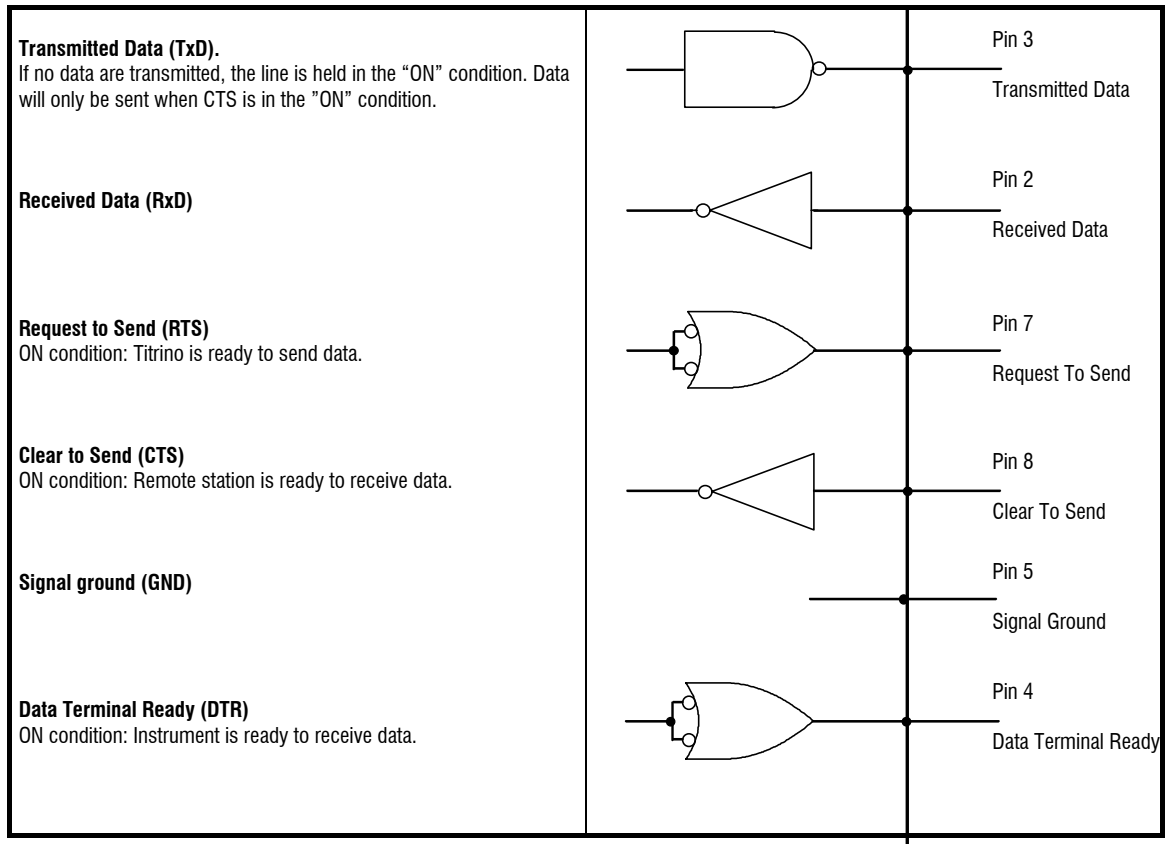

Protective earthing

Direct connection from cable plug to the protective ground of the instrument.

Polarity allocation of the signals

- Data lines (TxD, RxD)
 - voltage negative (< -3 V): signal state "ON"
 - voltage positive (> +3 V): signal state "ZERO"
- control or message lines (CTS, RTS, DTR)
 - voltage negative (< -3 V): OFF state
 - voltage positive (> +3 V): ON state

In the transitional range from +3 V to -3 V the signal state is undefined.

Driver 14C88 according to EIA RS 232C specification

Receiver 14C89 " "

Contact arrangement at plug (female) for RS 232C socket (male)

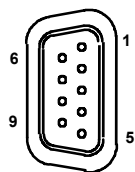

View of soldered side of plug

Ordering numbers:
K.210.0381 and K.210.9045

No liability whatsoever will be accepted for damage or injury caused by improper interconnection of instruments.

3.3.3 What can you do if the data transfer does not work?

Problem	Questions for remedial action
No characters can be received on a connected printer.	<ul style="list-style-type: none"> - Are the instruments switched on and cables plugged in correctly? - Is the printer set to "on-line"? - Are baud rate, data bit and parity the same on both instruments? - Is the handshake set properly? If everything seems to be ok, try to print a report with the key sequence <PRINT><SMPL DATA><ENTER>. If this report is printed out correctly, check if reports are defined in key <DEF>.
No data transmission and the display of the Titrino shows an error message.	<ul style="list-style-type: none"> - error 42: Transmission error. Is the printer set to "on-line"? Is the connection cable properly wired? - error 43: Data output of the Titrino disabled for longer than 6 s by XOFF. - error 36-39: Receive error. Are the RS settings the same on both devices?
The received characters are garbled.	<ul style="list-style-type: none"> - Are the RS settings the same on both devices? - Has the correct printer been selected? - Data transfer has been interrupted on the hardware side during the printout of a curve. Re-establish connections and switch printer off/on.
Wrong line spacing.	The printer does not emulate completely the preset mode. Usually these problems arise with the IBM mode. Set the printer to a different mode (e.g. Epson).
Printout of titration curve is not ok. Other reports are printed ok.	Handshake is necessary for the printout of curves. <ul style="list-style-type: none"> - Is your cable correctly wired? (The DTR of the printer has to be connected to the CTS of the Titrino.) - Set "HWs" for the handshake of the Titrino. Configure the printer such that its DTR is set (possibly with DIP switches).

4 Error messages, Troubleshooting

Data transfer inoperative See measures on page 131.

4.1 Error and special messages

XXX bytes missing	XXX bytes missing. For the storage of a method or a silo line XXX bytes are missing or there is insufficient RAM for a TIP sequence. Remedy: <QUIT>. Delete methods no longer needed or use fewer silo lines.
calibrate electrode	The calibration interval is expired. Exit: Carry out a calibration with mode CAL or delete calibration by entering data for pHas or slope in key <CAL.DATA>.
card battery low	The battery tension is between 2.37...2.64 V. Remedy: <CLEAR> and change battery as soon as possible.
card busy	The memory card is busy.
card not accessible	The card is not accessible because it is used by the RS interface or a card report is prepared.
card read/write error	Working with the card a read/write error appeared. Remedy: <CLEAR> or insert a different card.
card unformatted	Remedy: <CLEAR> and format the card.
card write-protected	Writing functions are not possible, if the card is write-protected. Remedy: <QUIT> and remove write protection, i.e. push write protection to the left.
change card battery	The date for changing the battery is expired. Leave the card in Titrimo during battery change to ensure constant power supply. Remedy: <CLEAR>, change the card battery and enter a new battery change date.
check electrode	With polarized electrodes. There is a break or short circuit. Possible causes and rectification of the fault: - the electrode is not plugged in ⇒ plug it in - the electrode is not immersed in the solution ⇒ immerse it - the electrode is defective ⇒ use new electrode. - the electrode cable is defective ⇒ use new cable. The electrode test can be switched off under the <PARAM> key. Exit: Rectify fault or <STOP>.
check exchange unit	The Exchange Unit is not mounted (properly). Exit: Mount Exchange Unit (properly) so that the coupling engages or <STOP>.
check remote box	The Remote Box is not (correctly) connected or the Remote Box is connected but not activated under the <CONFIG> key. Exit: Connect Remote Box (correctly) and set "Remote Box: ON" under <CONFIG>, >peripheral units. Switch the Titrimo off/on.

check T-sensor	No temperature sensor is attached (with MEAS T or if the temperature monitoring is active). Exit: Connect Pt100 or Pt1000 or <STOP>.
DX overload	The motor of dosing drive X has reached its current limit. Exit: <STOP> then <CLEAR>. The dosing drive will be initialized. If the error reappears after <CLEAR>, check the wet part: Can the cock and/or piston be moved?
data lost	The data of the memory card are lost as the battery tension was lower than 2.37 V. Exit: <CLEAR>.
data set reevaluation	Message if Titrimo is reevaluating downloaded measuring point lists.
directory already exists	The directory exists already. Remedy: <QUIT> and enter a different directory name or delete the directory with the same name.
division by zero	The result could not be calculated as a divisor in the formula was equal to zero. Exit: Enter appropriate value.
EP overflow	In a DET or MET titration 9 EP's or more were found. The first 9 EP's will be listed. Remedy: Recalculation of data with higher EP criterion.
manual stop	The determination has been manually stopped.
meas.pt list overflow	Maximum 500 measured points can be stored. Exit: Use start criteria or select larger time interval.
missing EP	An EP needed for calculation in a formula is missing.
missing fix EP	A fix EP needed for calculation in a formula is missing.
no.EP not corresponding	In DET or MET titrations, the number of EP's actually found does not match the set windows: Exactly 1 EP per window has not been found.
no EP set	In SET, no EP has been set. Exit: <STOP> and set EP.
no meas.quantity	In TIP a manual measurement (<MEAS/HOLD>) has been performed without defining a measuring quantity. Exit: <MEAS/HOLD> and define measured quantity.
no memory card	The memory card is not inserted (correctly). Remedy: <CLEAR> or rectify fault.
no method	The method required by the sample data from the silo memory or in a TIP sequence is not available in the method memory. Exit: <CLEAR>.
no new com.var.	The common variable could not be assigned as the result or the mean value could not be calculated. The old value remains in force.
no new mean	No new mean value has been calculated as at least one quantity stipulated for mean value calculations could not be calculated.
no new silo result	No new silo result C24 or C25 could be stored as the assigned quantity could not be calculated.
no new temp.var.	No new temporary variable C7X could be stored as the assigned quantity could not be calculated.

no sequence	No sequence is defined in TIP. Exit: <CLEAR> and define sequence.
no titration data	No curve can be printed as no data are available.
not possible	Writing functions on the card 6.6046.XXX are not possible.
not valid	A value is not available.
outside	The set fix EP is outside the measuring range.
overrange	The measuring range of ± 2 V has been exceeded. Overrange replaces the corresponding measured value (pH, U, I or temperature). If a measured value is in overrange (primary or secondary measured value), the other (secondary or primary measured value) can also be unstable.
result out of limits	The result lies outside the limits which were defined in the method, see page 39. Exit: Calculate result again or new start.
same buffer	In the calibration sequence the voltage difference between the first and second buffer is < 6 mV. Exit: <QUIT> and change buffer or <STOP> (abort calibration).
sample size out	The sample size is outside the limits which are defined in the method, see page 18. Exit: Enter new sample size.
save lines OFF	The function "save lines" is not active although a submethod of TIP contains assignments to C24 or C25. Exit: <CLEAR> and switch on "save lines" under <SMPL DATA> key. Warning: The results of this line will not be saved.
second TIP call	In TIP no further TIP can be called up as a submethod. Exit: <CLEAR> and define new sequence.
service is due	The service interval has elapsed. Contact Metrohm service so that the Titrino can be serviced. This message will appear each time the Titrino is switched on. Exit: New start.
silos empty	The silo memory is switched in but empty and a titration has been started. Corrective action: At least the first 1 silo line before starting the first titration. Exit: <CLEAR>.
silos full	The silo memory is full up. Corrective action: If you have filled less than 255 silo lines, you can create more space by deleting old methods no longer needed. 1 silo line needs 18...120 bytes. Exit: <CLEAR>.
stop EP reached	A DET or MET titration was stopped as the stop criterion "stop EP" was reached.
stop meas.val.reached	A DET or MET titration was stopped as the stop measuring value pH, U or I was reached.
stop time reached	SET has been stopped as the stop time has been reached.
stop V reached	The determination has been stopped as the stop volume has been reached.
system error 3	The instrument adjustment data have been overwritten. Exit: <CLEAR>. Default adjustment data are set. The error

	message appears each time the instrument is switched on until it has been readjusted (Metrohm service).
system error 14	<p>No communication between the Titrino and the connected Remote Box.</p> <p>Possible causes:</p> <ul style="list-style-type: none">. The Remote Box was connected when the Titrino was running. Titrino has a fault.. Remote Box has a fault. <p>Remedy: Set under <CONFIG>, >peripheral units, "Remote Box: OFF", switch off Titrino, take away Remote Box and switch on Titrino. Contact Metrohm service.</p>
time-out PC keyboard	<p>A connected PC keyboard has been used to call up an address (e.g. <F12>) and the connection has then been interrupted.</p> <p>Possible causes:</p> <ul style="list-style-type: none">. Remote Box has a fault.. PC keyboard has a fault. <p>Exit: Correct fault and switch Titrino off/on.</p>
TIP terminated	TIP has been terminated.
transmission error	<p>With a Remote Box connected characters are received which cannot be interpreted.</p> <p>Possible causes:</p> <ul style="list-style-type: none">. Wrong key combination has been pressed.. Wrong PC keyboard has been selected.. The barcode reader supplies garbled characters.. The Remote Box has a fault. <p>Exit: Rectify fault and switch Titrino off/on.</p>
validate instrument	<p>Validation interval has elapsed.</p> <p>Exit: <CLEAR> or new start.</p>
wrong card	<p>The card was inserted/removed during an operation with <CARD>.</p> <p>Exit: <CLEAR></p>
wrong sample	<p>With SET, with preset titration direction the first measured value is outside the end point.</p>

Error messages in connection with the data transfer

If neither a computer nor a printer is attached, the report output at the end of the titration must be switched off:

Receive errors:

- error 36** Parity
Exit: <QUIT> and set corresponding quantity the same on both instruments
- error 37** Stop bit
Exit: <QUIT> and set corresponding quantity the same on both instruments
- error 38** Overrun error. At least 1 character could not be read.
Exit: <QUIT>
- error 39** Overflow of the receive buffer of the Titrino (> 128 characters).
Exit: <QUIT>

Send errors:

- error 42** CTS=OFF
Handshake unsatisfactory for more than 1 s.
Exit: <QUIT> Is the receiver switched on and ready to receive?
- error 43** The transmission of the Titrino has been interrupted with XOFF for at least 6 s.
Exit: <QUIT>.
- error 45** The receive buffer of the Titrino contains an incomplete string (missing L_F). Transmission of the Titrino is thus blocked.
Exit: Send L_F or <QUIT>.

4.2 Diagnosis

4.2.1 General

The 798 MPT Titrino is a very precise and reliable instrument. Thanks to its rugged construction it is virtually impossible for external mechanical or electrical influences to have an adverse effect on its functions.

Although the occasional fault in the instrument can not be excluded completely, it is certainly much more likely that malfunctions are caused by wrong operation or handling or through improper connections and operation with non-Metrohm instruments.

It is advisable in each case to isolate the fault with the rapid and easy to perform diagnostic tests. The customer thus need not call METROHM service until there is a true fault in the instrument. In addition, with the aid of the numbering in the diagnostic program he can provide the service engineer with much more accurate information.

In inquiries always quote the manufacturing (page 3) and program number (see configuration, page 10) and specify possible error displays..

4.2.2 Procedure

- The diagnostic steps must be performed in sequence and compared with the reactions of the 798 MPT Titrino (indented). In the "yes" case, continue with the next instruction.
- If the instrument does not show the expected reaction ("no" case), the appropriate diagnostic step must be repeated to exclude an operating error. With repeated wrong reactions, however, there is a strong possibility that a malfunction exists.
- The diagnostic steps allow re-entry into the test routine for repetition if the following display appears:



diagnose press key 0...9

*If the instrument is in a subprogram of the diagnostic routine: Press <Clear>.
If need be, switch the power off then on again after a few seconds. At the same time press key <9> until the above display appears.*

- If <Clear> has been pressed during the display of '**diagnose press key 0...9**', the instrument returns to the user program.
- Error display: An error is shown in the display as follows:

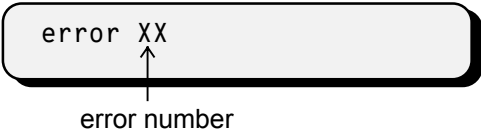

error XX

error number

- If a fault causes the burette drive to stick at the top or bottom end of the cylinder, see page 150, point 4.4

4.2.3 Equipment required:

- voltage calibrator, e.g. 1.773.0010 Metrohm pH Simulator
or 1.767.0010 Calibrated Reference for mV, pH, Ω μ S, $^{\circ}$ C
- highly insulated interconnection cable 6.2108.060
- resistor switch-box, class 0.1 % (or resistor 14.3 k, 0.1 %)
- cable 3.496.5070
- exchange units, if possible with different cylinder volumes (or 3.496.0070 dummy exchange unit)
- stop watch or watch with second hand
- digital or analogue voltmeter (if need be, connect a calibrated recorder)
- 2 connecting cables with 4 mm banana plugs
- test plug 3.496.8550 (necessary only if plug 'Remote' should be checked)
- test plug 3.496.8560 (necessary only if plug 'RS 232' should be checked)

4.2.4 Diagnosis steps

1 Prepare instruments for diagnostic test

- Power off.
- Disconnect all external connections (cables at rear, except mains cable and keyboard).
- Remove exchange unit.
- Power on and immediately press and hold the **<9>** key until the powerup test pattern disappears.

diagnose press key 0...9

2 Perform display test



- Press **<2>**.

display test

- Press **<Enter>**.

Characters for a visual check of the display are generated on the eight lines.

Test sequence:

- a) The display is cleared and overwritten from the top left to the bottom right with a dot pattern ().
- b) The display is cleared and overwritten from the top left to the bottom right with a dot pattern ().
- c) The display is continuously cleared and overwritten from the top left to the bottom right with the complete character set (see page 140 / Fig. 1). At the same time with moving display the LED's „COND.“, „STATISTICS“ and „SILO“ are switches on and off.

- The test sequence can be held and then continued at any time by pressing **<5>**.
- Block 2 is quit by pressing **<Clear>**.

diagnose press key 0...9

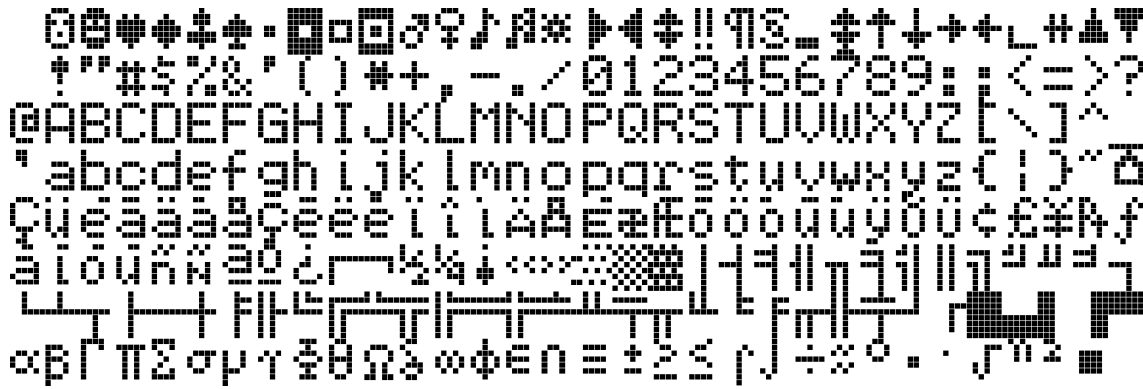

Fig. 1 Complete character set

3 Keypad test

- Press **<1>**.



- Press **<Enter>**.

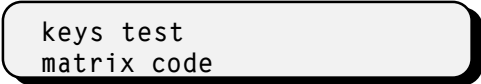

- If any key is now pressed (on the 6.2132.090 keypad or on the front panel of the 798), the appropriate matrix code appears in the display.

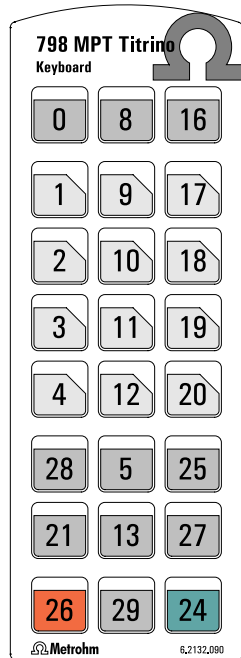

Fig. 2 Keypad 798

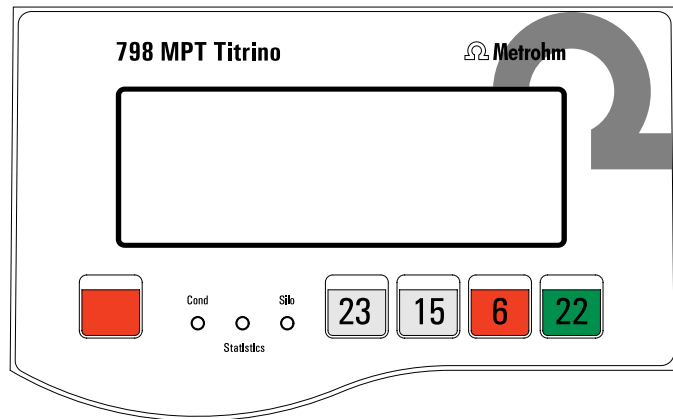

Fig. 3 Front panel 798

- Block 1 is quit by pressing the **<Clear>** key twice.



4 Cylinder code, date, time

- Insert exchange unit or dummy to the internal dosing unit D0 and put the burette tip into a collecting receptacle.
- If available, connect the external dosing units D1 or D2 with the exchange units.
- Press **<0>**.

date/time
cylinder code

- Press **<Enter>**.

activated dosing unit

date XX-XX-XX XX:XX:XX
code:D0 XX ml

mL-code

- Check date and time.
- Check whether the ml-code does correspond with the exchange unit placed or not. *For the sake of completeness, different exchange units can be inserted to check their ml code. If desired, the exchange unit can be removed again. If no exchange unit is inserted display does not show the ml-code but „check exchange unit !“.*
- If external dosing unit are connected, select the dosing unit in question with key **<=>**.
Check the external dosing unit in the same way as before the internal. If no dosing unit is connected display does not show the ml-code but „check drive unit !“.
- Press **<Clear>**.

diagnose press key 0...9

5 Motor timer test

- Press **<6>**.

motor-timer test

- Press **<Enter>**.

pot.meter dV/dt → 10?

- Turn knob '**dV/dt**' to the right stop and press **<Enter>**.

Test sequence:

- In a first step, the frequency of the RC oscillator (analogue rate) is tested over a period of 1 second.*
- In a second step, the frequency of the quartz oscillator (digital rate) is tested over a period of 1 second.*
- If no error is found, after about 5 s it appears*

motor-timer test o.k.

- Press **<Clear>**.

diagnose press key 0...9

6 Analogue input test

- Press **<7>**.

analog input test 1...5

6.1 Examination of highly insulated measuring inputs

- Connect 'Ind I' measuring input to a voltage calibrator (e.g. Metrohm 773 pH simulator) by means of a highly insulated cable (e.g. 6.2108.060). Set calibrator to 0 V.

- Press **<1>**.

Input 1 0.0 mV

Tolerance: ± 0.5 mV

- Set the calibrator voltage, on setting 'low ohmic' (with 773 = ~ 0.002 M Ω) to different values (e.g. +1500 mV) and compare with the displayed value.

Tolerance (with $\pm 1500 \div 2000$ mV) ± 1 mV. Be aware of the calibrator's tolerance.

- Set simulator to high ohmic condition (with 773 = 1000 M Ω).

The displayed reading may vary slightly only (with 1500 mV ≤ 1 mV)

- Press **<Clear>**.

analog input test 1...5

- Disconnect simulator from 'Ind I' input and connect to 'Ind II' input.

- Press **<2>**.

Input 2 XX mV

- Carry out the same measurements as with Input 1.

- Press **<Clear>**.

analog input test 1...5

- Short-circuit input 'Ind I' (e.g. with cable 3.496.5070).

- Press **<3>**.

Input 1-2 XX mV

The differential voltage between inputs 'Ind I' and 'Ind II' is displayed.

Example: 0 - (+)1500 mV = -1500 mV

- Remove cables from the inputs 'Ind I' and 'Ind II'.

- Press **<Clear>**.

analog input test 1...5

6.2 To check Pt 100 / 1000 connection

- Connect a Pt 100 or Pt 1000 sensor, a resistor switch-box or a single resistor of 100 Ω or 1 kΩ, respectively, to sockets 'Pt 100/1000' by means of short cables.
- Press **<4>**.

Pt 100* XX °C

(* or Pt 1000)

Tolerance: ± 0.5 °C (Note also tolerance of resistor switch-box).

The sensor allows automatic displaying of the room temperature. (The resistor values correspond to 0°C.)

- Press **<Clear>**.

analog input test 1...5

- Remove cables and resistor switch-box.

6.3 Polarizer test

- Press **<5>**.

polarizer test

- Press **<Enter>**.

dummy resistor 14.3kΩ ?

- Connect resistor switch-box (or suitable resistor 14.3 kΩ 0.1%) using 3.496.5070 cable to 'Pol' socket. Switch-box to 14.3 kΩ.
- Press **<Enter>**.

Test sequence:

1. An asterisk flashes during the test.
2. In case of an error an error message appears. (If for example the switch-box is not connected, **error 100** appears).
3. If no error is found, after about 15 s display shows

polarizer test o.k.

- Press **<Clear>**.

analog input test 1...5

- Press **<Clear>**.

diagnose press key 0...9

- Remove cable and resistor switch-box.

7 External inputs and outputs

This test is meaningful only if the 798 MPT Titrimo is used interconnected with other instruments via the 'Remote' connection. In addition, a 3.496.8550 test plug normally used in the repair service is required for this test. However, this plug can also be purchased by customers under the above number.

For the sake of completeness, the procedure is described here. If a diagnostic test of the external inputs and outputs is not required, continue with point 8.

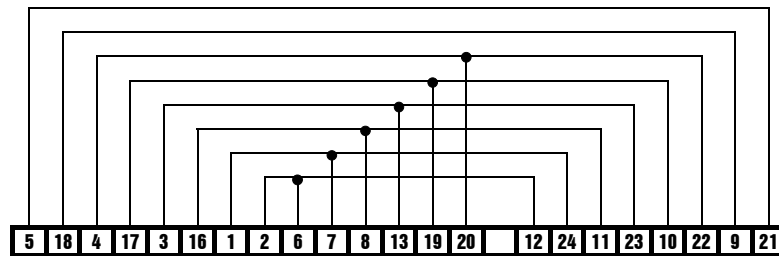

Fig. 4 Connections in the 3.496.8550 test plug

- Press **<4>**

extern input/output test

7.1 Test of the remote interface

- Press **<1>**.

extern input/output test

- Press **<ENTER>**.

I/O-test-connector?

- Insert the 3.496.8550 test plug in port B 'Remote'. (Do not switch off instrument!)
- Press **<ENTER>**.

Test sequence:

1. In case of an error an error message is displayed. If for example no test plug is connected, error message **error 50 01HEX** appears).
2. If no error is found, after about 1 s display shows

extern input/output o.k.

- Remove test plug.
- Press **<CLEAR>**.

diagnose press key 0...9

7.2 Test of the remote box

The remote box needs to be connected before the Titrimo is switched on. Insert 3.496.8550 test plug in the remote box.

- Press **<2>**.

reset remote box?

- Press **<ENTER>**.

Test sequence:

1. In case of an error an error message is displayed (for example **error 490 01HEX**).
2. If no error is found, after about 1 s display shows

remote box test o.k.

- Press **<CLEAR>**. The dialogue switches automatically to the "extern i/o test".

extern input/output test

- If this test should not be carried out (see 7.1), quit block 4 pressing **<CLEAR>** twice.
- Remove test plug.

diagnose press key 0...9

8 RS 232 test

A 3.496.8560 test plug normally used in the repair service is required for this test. However, this plug can also be purchased by customers under the above number.

For the sake of completeness, the procedure is described here. If a diagnostic test of the RS 232 interface is not required, continue with point 9.

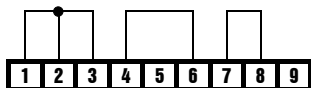

Fig. 5 Connections in the 3.496.8560 plug

- Press **<5>**.

RS232 test 1...2

8.1 RS232 test 1

- Press **<1>**.

```
RS232 test-connector? 1
```

- Insert the 3.496.8560 test plug in port 'A1'.
- Press **<Enter>**.

Test sequence:

1. In case of an error an error message is displayed. If for example no test plug is connected, error message **error 68** appears).
2. If no error is found, after about 5 s display shows

```
RS232 test 1 o.k.
```

- Remove test plug.
- Press **<Clear>**.

```
RS232 test 1...2
```

8.2 RS232 test 2

- Press **<2>**.

```
RS232 test-connector? 2
```

- Insert the 3.496.8560 test plug in port 'A2'.
- Press **<Enter>**.

Test sequence:

1. In case of an error an error message is displayed. If for example no test plug is connected, error message **error 68** appears)
2. If no error is found, after about 5 s display shows

```
RS232 test 2 o.k.
```

- Remove test plug.
- Press **<Clear>**.

```
RS232 test 1...2
```

- Press **<Clear>**.

```
diagnose press key 0...9
```

9 Memory card test

- Press **<9>**.

memory card test

- Insert memory card.

The memory card has to be formatted from a 798 MPT Titrimo otherwise the test does not recognize the card and on the display appears „memory card 000 KB end“.

- Press **<Enter>**.

The test runs automatically. If no fault arises then there appears:

memory card 128 KB o.k.

- Press **<Clear>**.

diagnose press key 0...9

10 Internal dosing unit D 0

- Insert exchange unit and put the burette tip into a collecting receptacle.
- Press **<Clear>**.

The Titrimo gets out of the diagnosis menu and returns to the user program.

- The spindle drive and the cock changeover drive of the internal dispensing unit can be checked with the aid of the function **<prep>** (see page 103).
- Set the parameters of this function accord. to the following list (for setting the parameters see page 10).

```
configuration
>prep.dosing elements
power ON prep:      OFF
report:             OFF
dos.element: internal D0
warn.interv.D0     OFF min
volume D0          3.5 ml
cycles D0          2
dos.rate DX max. ml/min
fill rate DX max. ml/min
```

- Press **<Prep>**.

intern D0 prep

11 Setting up original arrangement

Reconnect all peripherals disconnected at the start of the diagnostic routine and perform a short function test with these.

4.3 Initialise and test RAM

On the odd occasion large disturbing signals (e.g. mains spikes, lightning, etc.) can have an adverse effect on the processor functions and hence lead to a system crash. After such a crash the RAM area must be initialised. Although the basic instrument data remain stored, the RAM initialisation should be performed only when necessary since the stored user data (configuration, parameters, calculation variables, etc.) are cleared as a result.

- Power OFF
- Power ON and simultaneously press keys **<DOS>** and **<STOP/FILL>**.

RAM Init.

- Press **<START>**.

confirm RAM Init.

- Press **<START>**.

RAM Init. activ

RAM is tested and initialised. Subsequently a warm start is executed.

The lost data of the user memory must now be reentered.

If **'system error 3'** appears in the display, **<Clear>** can be used to return to the instrument program. The initialisation values are loaded automatically. The instrument thus remains capable of measurement. However, possibly a small loss in accuracy must be anticipated. A new optimum adjustment can be performed by Metrohm service. The error message 'system error 3' always appears after the instrument is switched on until this adjustment has been performed.

4.4 Releasing a locked spindle with inserted Exchange Unit

- The burette drive may very occasionally jam at the top or bottom end of the cylinder. If jamming occurs at the top or when the drive is out of function, the Exchange Unit can no longer removed. In this case, it is necessary to proceed as follows:

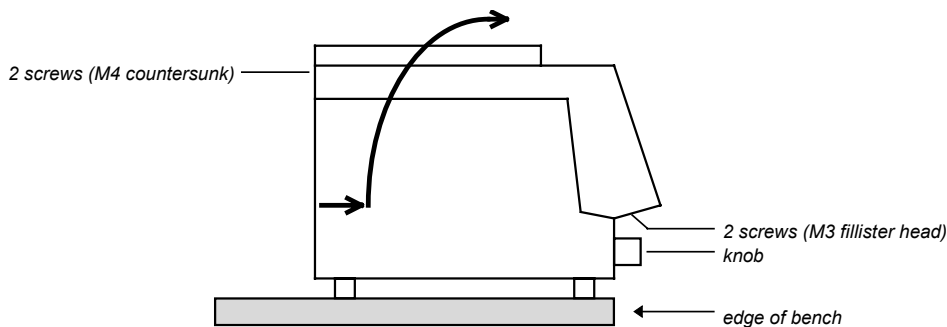

Fig. 8

- Disconnect instrument from power supply!
- Remove control knob
- Place instrument over edge of bench to allow the M3 screws to be removed (Fig. 8)
- Remove M4 screws
- Lift off top part of instrument together with Exchange Unit in the manner shown by the arrow



**The electronic circuits are now accessible!
On no account touch these!**

- Remove spindle from mechanical stop by turning the large gear wheel. (In case that the motor is inoperative, position spindle by hand to zero position.)

5 Preparations

The mains cables supplied with the instrument are three-core and equipped with a plug with an earthing pin. If a different plug has to be fitted, the yellow/green lead must be connected to the protective earth. Each break in the earthing inside or outside the instrument can make it a hazard.

When the instrument is opened or if parts of it are removed, certain components may be live if the instrument is connected to the mains. The mains cable must therefore always be unplugged when certain adjustments are made or parts replaced.

5.1 Setting up and connecting the instruments

5.1.1 Titrino with Stirrer or Titration Stand

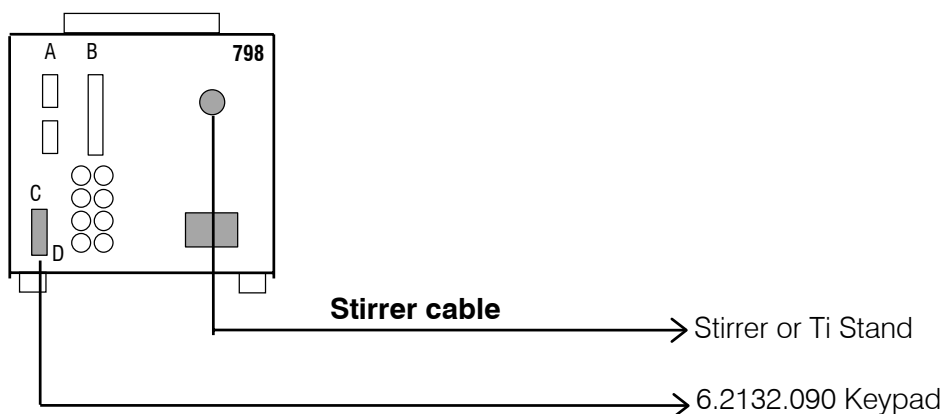



The 802 Rod Stirrer, the 727, or the 703 Ti Stand with 6.2108.100 cable can also be connected instead of the 728 Magnetic Stirrer.

5.1.2 Connection of a printer

A variety of printers can be connected to the RS232 interface of the Titrino. If you connect a printer other than one of those mentioned below, ensure that the Epson mode is emulated or that it uses the international character set following the IBM Standard Table 437 and IBM-compatible graphics control characters.

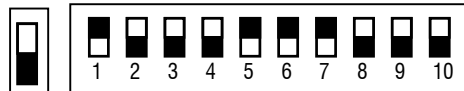
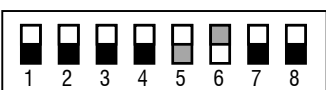
If a **balance** is connected at the same COM of the Titrino as a printer, you need the 6.2125.010 + 6.2125.030 Adapters.

Printer	Cable	Settings on Titrino	Settings on Printer
Seiko DPU-414	6.2134.110	baud rate: 9600 data bit: 8 stop bit: 1 parity: none handshake: HWs send to: Seiko	none
Custom DP40-S4N	6.2134.110	baud rate: 9600 data bit: 8 stop bit: 1 parity: none handshake: HWs send to: Citizen	none, pre-set on Metrohm version IDP-560 EMULATION FONT MAP =GERMANY PRINT=REVERSE LITTLE CR CODE=VOID CR AFTER B :FULL=VOID CR ON b. EMPTY=VALID BUFFER 1K BYTE BAUD RATE=9600 PROTOCOL=8,N,1 FLOW CONTROL CTS-RTS
Citizen iDP562 RS	6.2134.050	baud rate: 9600 data bit: 8 stop bit: 1 parity: none handshake: HWs send to: Citizen	ON  SSW1
Epson LX-300	6.2134.050	as above, but send to: Epson	see printer manual
HP Desk Jet with serial interface	6.2134.050	baud rate: 9600 data bit: 8 stop bit: 1 parity: none handshake: HWs send to: HP	A: A4 paper  B: 
HP Desk Jet with parallel interface	2.145.0330 RS232/ Parallel Converter	baud rate: 9600 data bit: 8 stop bit: 1 parity: none handshake: HWs send to: HP	see printer manual

5.1.3 Connection of a balance

The following balances can be connected to the RS232 output of the Titrino:

Balance	Cable
Sartorius MP8, MC1	6.2134.060
Shimadzu BX, BW	6.2125.080+6.2125.010 Settings on Titrino: balance SARTORIUS Balance: delimiter CR+LF
Ohaus Voyager, Explorer, Analytical Plus	from Ohaus: AS017-09 (Ohaus parts number) Settings on Titrino: balance SARTORIUS Balance: SET BALANCE INTERFACE BAUD RATE 9600 DATA BITS 8 PARITY none STOP BITS 1
Mettler AB, AG (LC-RS25)	in the scope of delivery of the balance
Mettler AM, PM	6.2146.020 + 6.2125.010 additionally from Mettler: ME 47473 Adapter and ME 42500 hand switch or ME 46278 foot switch
Mettler interface 016	Cable in scope of delivery of interface 016: red lead to pin 3, white lead to pin 7 of the 25-pin connector + 6.2125.010 25-pole/9-pole adapter
Mettler interface 011 or 012	6.2125.020 + 6.2125.010
Mettler AT	6.2146.020 + 6.2125.010
Mettler PG, AB-S	6.2134.110
Mettler AX, MX ,UMX	6.2134.120
AND Models ER-60, 120, 180, 182 Models FR-200, 300 Models FX-200, 300, 320 with RS232 interface (OP-03)	6.2125.020 + 6.2125.010
Precisa, balances with RS232C-interface	6.2125.080 + 6.2125.010

The balance type must be preselected at the Titrino with the <CONFIG> key.

The weight is transferred as a number with up to 6 digits, sign and decimal point. Units and control characters sent by the balance are not transmitted.

With the aid of a special input unit supplied by the balance manufacturer, in addition to the weight identifications and methods can be

inputted from the balance. For this, the address of the identifications and method, resp. must be preselected on the input unit.

Balance	Method	Id1	Id2	Id3
Sartorius	METH or 27	ID.1 or 26	ID.2 or 24	C-20 or 23
Mettler (AT)	D (Mthd)	C (ID#1)	B (ID#2)	A (c20)

If balance and printer are connected at the same Titrimo COM you need the 6.2125.010 and 6.2125.030 Adapters.
If the balance works only with 7 bit and the printer with 8 bit and if they are at the same Titrimo COM, the balance has to bet to "space parity" and Titrimo/printer to 8 bit, "no parity".

5.1.4 Connection of a Sample Changer

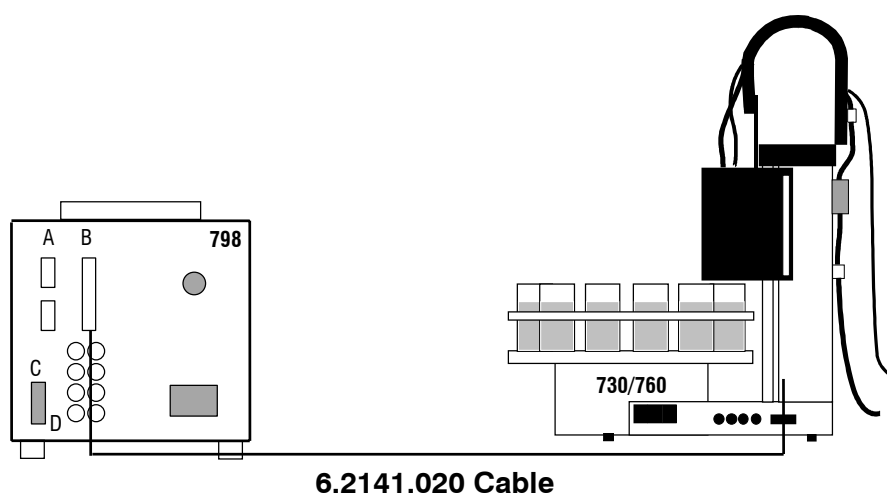

With 6.2141.030 cable (instead of 6.2141.020), two Titrimos can be connected to the 730 or 760 Sample Changer at the same time.

- The "Remote" socket allows not only connection of a sample changer but also additional control functions. Pin assignment of the "Remote" socket and control possibilities, see page 165f.
- If a calibration has to be performed with the sample changer, the calibration parameter "sample changer:" must be set to "ON".
- In connections with the sample changer, "auto start" should be set to "OFF" in the <CONFIG> key. The start command is given by the Sample Changer.

5.1.5 Connection of a computer

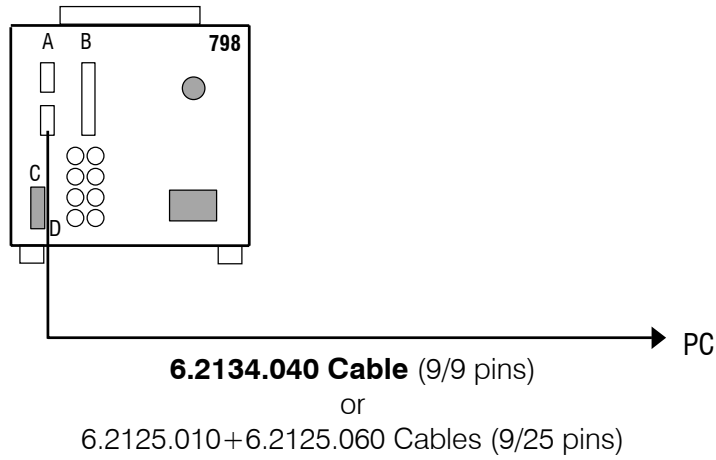

Preselections on the Titrino:

- RS232 settings: depend on the control program of the computer
- Send to: IBM
- Vesuv 3.0, PC program for data acquisition and method backup
 - for up to 64 devices 6.6008.200
 - for 2 devices 6.6008.500

5.1.6 Connection of a Remote Box

A barcode reader and/or a PC keyboard can be connected to 6.2148.000 Remote Box. The barcode reader and PC keyboard are used as input aids.

Only plug in and unplug the Remote Box when the Titrino is switched off! The Remote Box is screwed onto the "Remote" socket of the Titrino. The remote lines of the Titrino are then accessible at the "Remote" socket of the Remote Box.

5.1.6.1 Connecting a barcode reader

Barcode readers with a 5-pole DIN plug can be connected to 6.2148.000 Remote Box. A precondition is that the barcode reader can emulate a PC keyboard. If a barcode reader and a PC keyboard are to be connected at the same time then the barcode reader must have a T-connection plug. The PC keyboard will then be plugged into this barcode reader connection.

Settings at the Titrino:

Under key <CONFIG>, >peripheral units, "Remote Box: on"

Barcode:

input	The barcode string goes to the entry field in which the cursor is currently located.
method	If the silo memory is switched on the barcode string always goes to the method. The cursor position has no effect. If the silo memory is switched off the input has no meaning.
id1	The barcode string always goes to id1. The cursor position has no effect.
id2, id3	As for id1.
smp1 size	The barcode string always goes to the sample size. The cursor position has no effect. If the silo memory is switched on the silo line will be concluded with the sample size and the cursor moves to the next silo line.

Settings at the barcode reader:

Plug the barcode reader into the Remote Box. The barcode reader instruction manual contains the codes which you must enter.

1. Bring the barcode reader into the programming mode.
2. Make the necessary setting for emulating a PC keyboard (may be country-specific).
Select <ENTER> or "CR + LF" as termination sign.
3. Exit the programming mode.

Notes:

- If longer characters chains than are permitted by the corresponding input are transmitted then the first n characters will be accepted; the last characters will be cut off.
- If the silo memory is switched on and the settings "barcode: method" or "barcode: idX" are operative, the first silo line will be created when the string is received. Higher silo lines than 1 are only created and concluded with the sample size.

5.1.6.2 Connecting a PC keyboard

PC keyboards with a 5-pole DIN plug can be connected to 6.2148.000 Remote Box. For keyboards with a PS/2 plug an adapter PS/2→DIN is available in PC shops.

Settings at the Titrino:

Under key <CONFIG>, > peripheral units, "Remote Box: on"

Keyboard:

Select the country-specific keyboard layout of your PC keyboard.

If the Titrino does not support your keyboard you should select a keyboard which has the closest possible layout (for example check the 2nd occupancy of the numerical keys).

Country-specific special characters will probably not be converted correctly.

Operating via a PC keyboard:

The Titrino can be operated from the PC keyboard. The Titrino functions are called up as follows:

Titrimo function	Key combination on PC keyboard	Remarks
<C-FMLA>	Alt F	
<CAL.DATA>	Alt C	
<CARD>	Alt M	
<CLEAR>	F5	
<CONFIG>	F10	
Cursor ↑ ↓	Cursor ↑ ↓	Navigation
Cursor → ←	Cursor → ←	Selection of inputs
<DEF>	Alt D	
DEF: formula input, common variable, mean value: EP RS MN C	E R M C	Input of corresponding quantity or variable together with the numerical address, e.g. R1 gives RS1.
<ENTER>	enter	
<MEAS/HOLD>	F9	
<MODE>	F2	
<PARAM>	F11	
<PRINT>	Alt P	Report selection with → ←
<QUIT>	ESC	
<REPORTS>	Alt O	Printout reports: Alt P + Alt O
<SILO>	F4	on/off
<SMPL DATA>	F12	
<START>	F7	
<STATISTICS>	F6	on/off
<STOP>	F8	
<USER METH>	F3	
<USER>	Alt U	

The numerical block (with NumLock) and the number keys on the PC keyboard simulate the functions of the numerical keys on the Titrino. For example, entering <7> in the basic state of the Titrino switches the statistics on.

Keys which are used for setting an accent (e.g. ^, ´) are converted immediately. If you try to enter ê the Titrino will display ^e instead.

The occupancy of the PC function keys is shown to the right as an overlay. You can copy this diagram, cut out the central part and place it above the function keys of your PC keyboard.

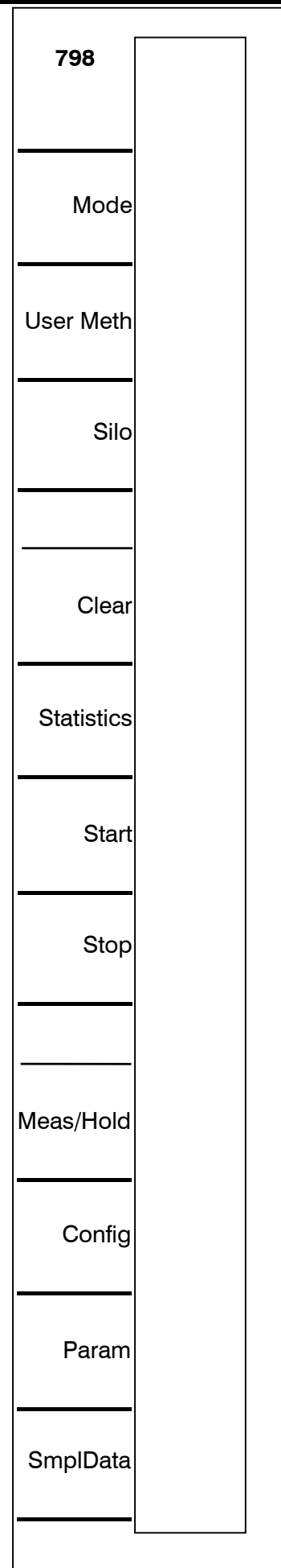

5.2 Connection of electrodes, preparing titration vessel

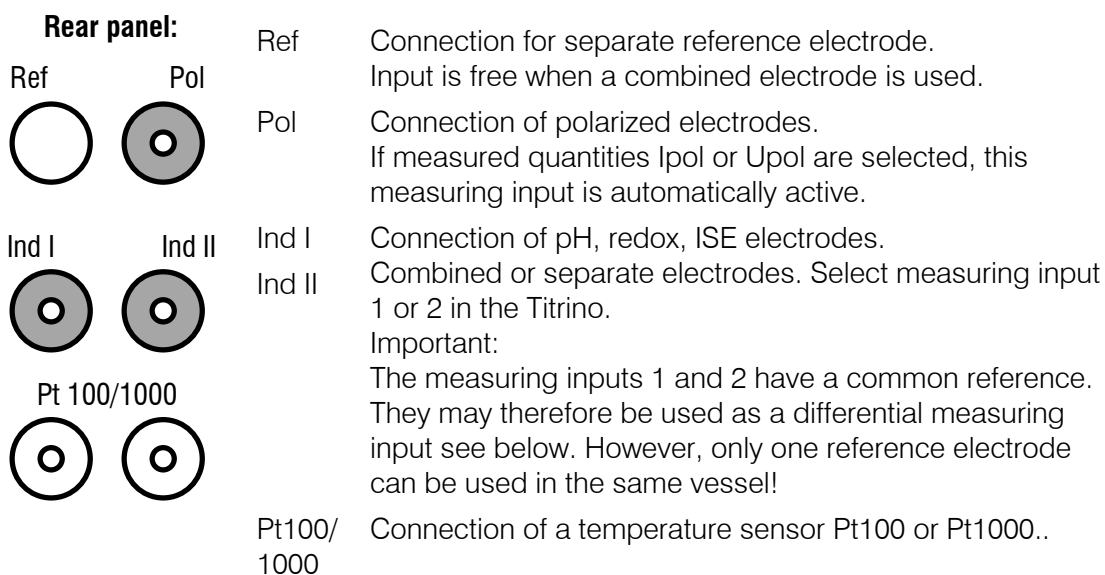

Differential potentiometry

In potentiometric measurements in media of low conductivity, e.g. in organic solvents, high-impedance electrode assemblies such as pH electrodes record noise voltages which arise from stray electrostatic and electromagnetic fields. Particularly high field strengths occur through friction at insulators such as plastic floors, synthetic clothing, etc.; conditions which can appear in every normal laboratory environment.

Problems of this type can be solved by measurement using a differential amplifier. Here, the indicator and reference electrode are each connected to a high-impedance measuring input. It is important to ensure that both electrodes have identical shielding and are thus symmetrical with regard to the recording of noise signals. An auxiliary electrode provides the electrical connection between the reference point of the amplifier circuit and the measurement solution. Recommended electrodes:

Meas.input	Manual determinations	Sample Changers
Ind I	6.0133.100 pH Glass electrode	6.0130.100 pH Glass electrode
Ind II	6.0729.100 double-shielded Ag/AgCl reference electrode	6.0729.110 double-shielded Ag/AgCl reference electrode
Ref	6.0301.100 auxiliary electrode	6.0302.110 auxiliary electrode

Practical tips

- Glass electrodes should be preconditioned in the solvent used for ca. 1 hour.
- If the potential jump after the first dispensing step is too large, a small start volume may help.
- As an "auxiliary electrode", the 6.1808.030 burette tip with earthing may be used in some cases. Use burette tips without anti-diffusion valve!

Setting up the titration vessel

The titration vessel is set up as shown in Fig. 5-6. During a titration, it is important to ensure that the solution in contact with the electrode is thoroughly mixed. This is achieved by

- efficient stirring. But it should not be too fast, otherwise the stirrer vortex will suck in air bubbles and CO₂ or O₂ can disturb the titration.
- placing the buret tip according to the drawing below for maximum distance between the adding of the titrant and the electrode.

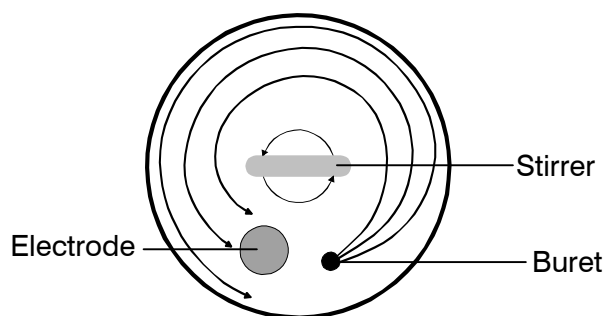

Pay attention on the direction of rotation of the stirrer!

6 Appendix

6.1 Technical specifications

Modes	DET: D ynamic E quivalence Point T itration MET: M onotonic E quivalence Point T itration SET: S et E nd point T itration MEAS: M easurement CAL: pH c alibration TIP: Links commands to t itration p rocedure
Measuring inputs	2 high-impedance measuring inputs for pH, redox and ISE electrodes. 1 reference input for a separate reference electrode. May also be used as a differential amplifier. 1 measuring input for polarized electrodes. 1 measuring input for temperature sensor Pt100 or Pt1000.
Measuring range	
pH value (pX)	0...±20.00, resolution 0.01
Voltage	0...±2000 mV, resolution 1 mV, error limit 0.1 % fullscale
Current	0...±200 µA, resolution 1 µA
Temperature	-150.0...+450.0 °C, resolution 1 °C
Polarizer	Ipol 0...±127 µA, resolution 1 µA
Upol	0...±1270 mV, in steps of 10 mV
Measuring amplifier (at 25 °C and Titrino warmed-up)	
Input resistance	> 10 ¹³ Ω
Offset current	< 3 * 10 ⁻¹³ A
Deviation of offset voltage	15 µV/K
Dosification	
Volume of buret cylinder	1, (2), 5, 10, 20 or 50 mL
Resolution	10 000 steps per buret cylinder
Auxiliary burets	2 additional burets: 776 or 765 Dosimat
Materials	
Housing	Polybutyleneterephthalate (PBTP)
Keypad cover	Polycarbonate (PC)
Display	Graphical LCD, 192 x 64 Dots Field: 100 x 37 mm LED back-lit

Memory card

Standard	JEIDA ICMC 4.0 / PCMCIA (68 pins)
Data	Method memory
Storage capacity	128 KB (256 KB maximum)
SRAM card	Write and read, battery supplied
Flash	Read only with 55 Metrohm methods

Internal memory

Method memory for up to 100 methods
Silo memory for sample data and results

RS232 interface

2 separate interfaces, each can be configured for printer, balance or computer connection: completely controllable from external control unit

Remote input/output lines

for Sample Changer, robot connection.
With optional Remote Box:
Connection of barcode reader and PC keyboard.

Stirrer control

Switch the stirrer on/off either manually or coordinated with the titration sequence

Ambient temperature

Nom. operation range	5 ... 40 °C
Storage	- 20 ... 60 °C
Transport	- 40 ... 60 °C

Safety specifications

Designed and tested in accordance to IEC publication 1010, safety class I. This manual contains information and warnings which have to be followed by the user to ensure safe operation and to retain the apparatus in safe condition.

Mains connection

Voltage	100...240 V
Frequency	50 ... 60 Hz
Power consumption	15 W
Fuse	2 x 1 ATH (to be replaced by Metrohm Service only using the same type) Additional electronic overload protection

Dimensions with Exchange Unit

Width	150 mm
Height	450 mm
Depth	275 mm

Weight, incl. keypad app. 3.6 kg

6.2 Pin assignment of the "Remote" socket

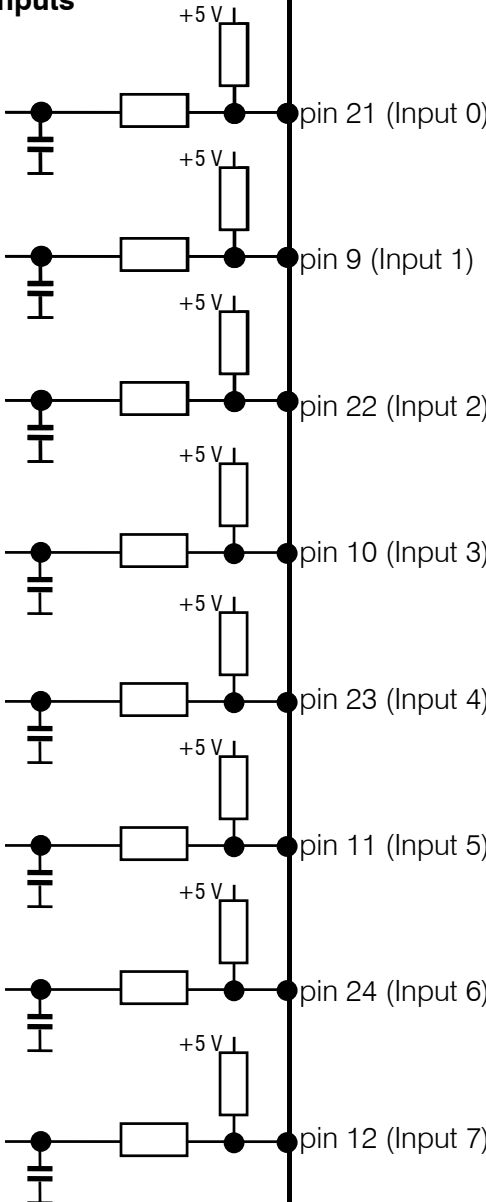
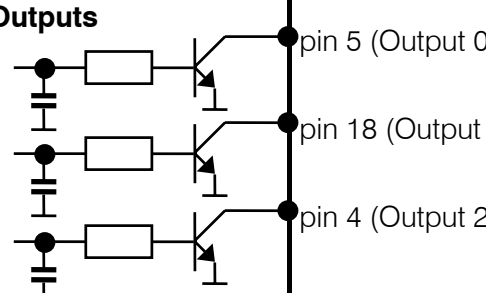
	external	Function
Inputs 	pin 21 (Input 0)	Start
	pin 9 (Input 1)	Stop
	pin 22 (Input 2)	Enter
	pin 10 (Input 3)	Clear
	pin 23 (Input 4)	Sample ready
	pin 11 (Input 5)	not used
	pin 24 (Input 6)	
	pin 12 (Input 7)	
Outputs 	pin 5 (Output 0)	Ready inactive
	pin 18 (Output 1)	Conditioning ok, active if Cond.ok
	pin 4 (Output 2)	Titration, active during titration

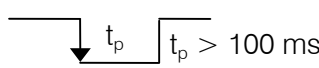

$t_p > 100 \text{ ms}$

Functions see page 167

Are not used in titration sequences

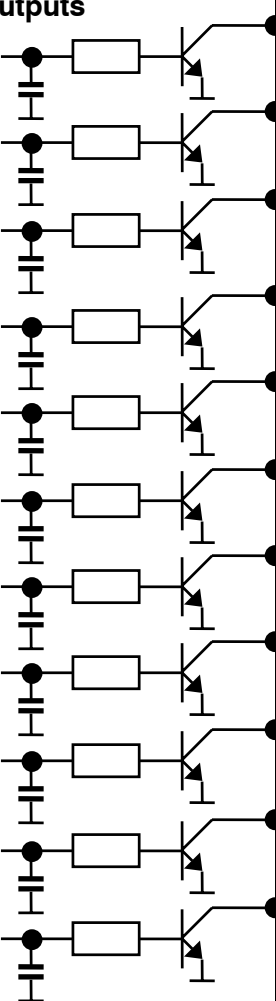
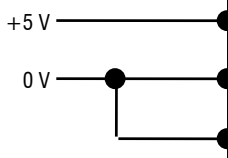
<p>Outputs</p> 	<p>pin 17 (Output 3)</p> <p>pin 3 (Output 4)</p> <p>pin 16 (Output 5)</p> <p>pin 1 (Output 6)</p> <p>pin 2 (Output 7)</p> <p>pin 6 (Output 8)</p> <p>pin 7 (Output 9)</p> <p>pin 8 (Output 10)</p> <p>pin 13 (Output 11)</p> <p>pin 19 (Output 12)</p> <p>pin 20 (Output 13)</p>	<p>End of determination EOD</p> <p>L4 in TIP</p> <p>Error, active with errors</p> <p>Activate pulse, see page 167. L6 in TIP</p> <p>Pulses for recorder ($t_p = 150 \mu\text{s}$) 10 000 per buret cylinder</p> <p>Remote box active</p> <p>not used</p> <p>not used</p> <p>not used</p> <p>Sample size out of limits</p> <p>Result out of limits</p> <p>For all outputs: $V_{CE0} = 40 \text{ V}$ $I_C = 20 \text{ mA}$ $t_{\text{Pulse}} > 100 \text{ ms}$ Functions see page 167.</p>
<p>Voltage</p> 	<p>pin 15</p> <p>pin 14</p> <p>pin 25</p>	<p>$I \leq 200 \text{ mA}$</p> <p>0 V: active 5 V: inactive</p>

Ordering numbers for plug:
K.210.9004 (shell) and K.210.002

No liability whatsoever will be accepted for damage caused by improper interconnection of instruments.

6.2.1 Lines of the "Remote" socket during the titration

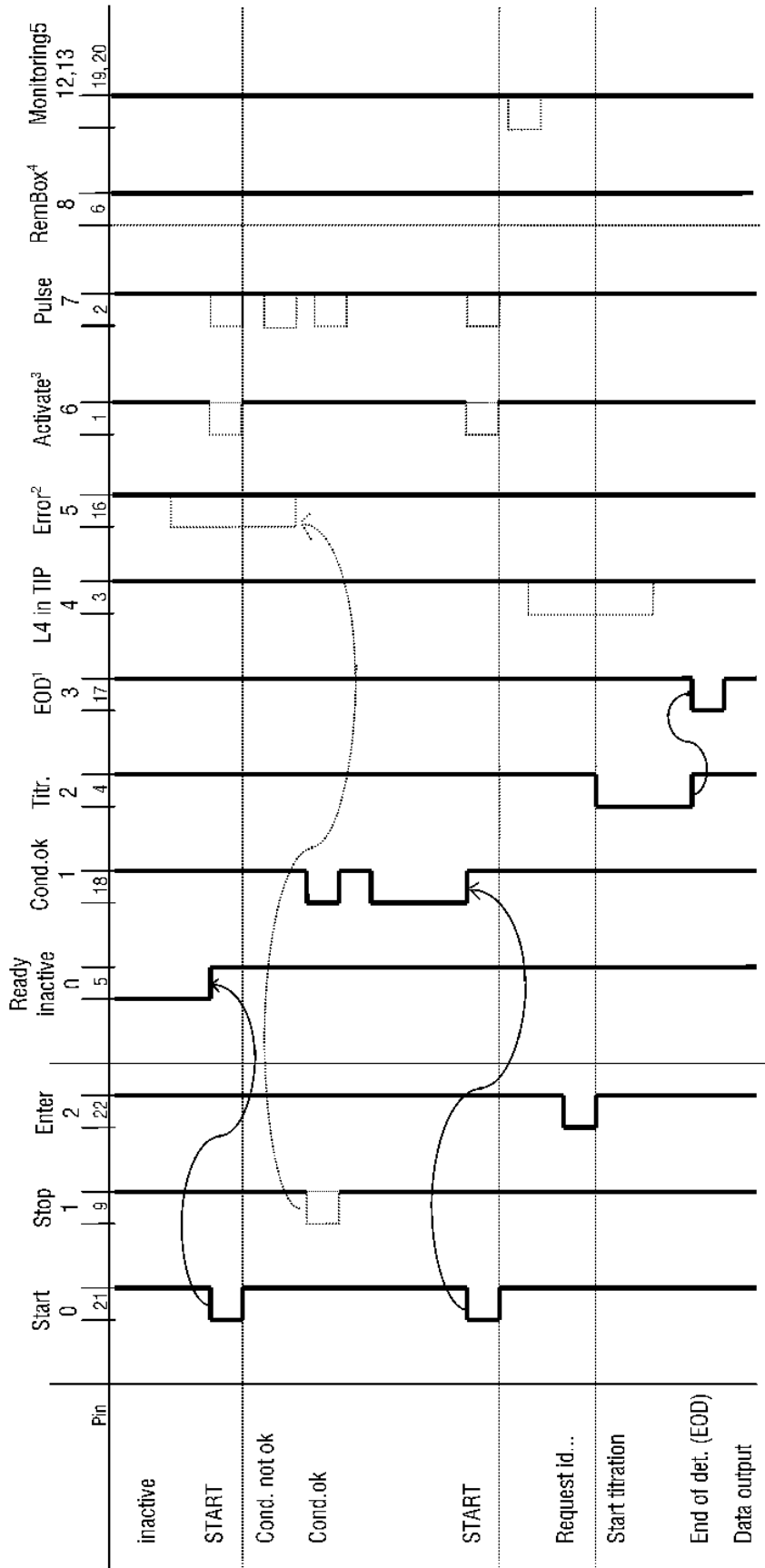

- Inputs**
- 1: In CAL, EOD is sent after every buffer. Automatic output of EOD can be switched off via RS232, see page 120.
 - 2: The error line is reset when the error is rectified.
 - 3: Line used in TIP as L6.
 - 4: Line is active if a remote box is registered, see page 9.
 - 5: Line L12 is active if sample size is out; L13 can be set if the result is out of limits, see page 39. The output lines L9, L10, L11 are free.
- Outputs**

6.2.2 Possible configurations of the activate pulse in SET and CAL

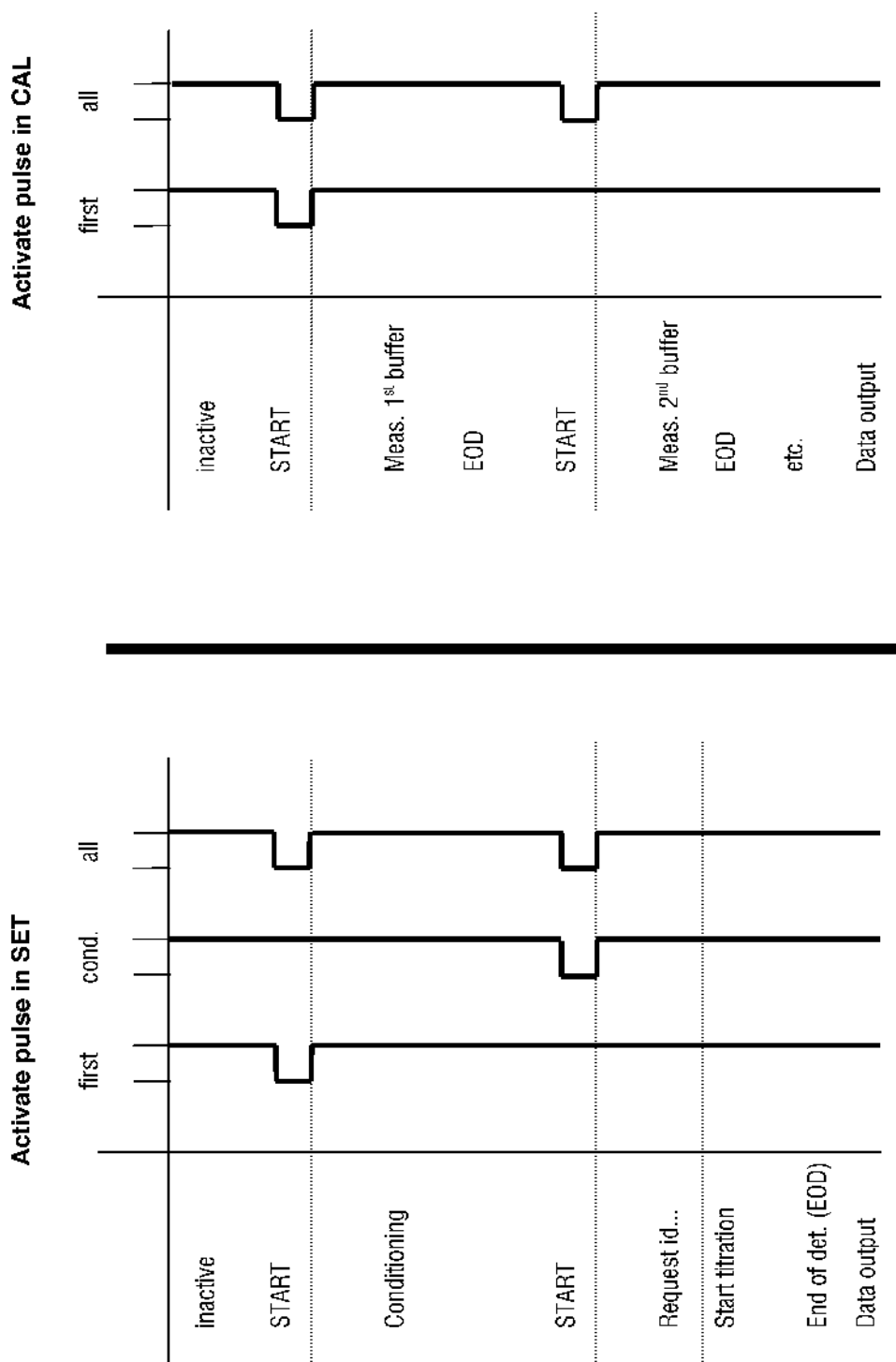

6.3 Titrino validation

Checking and maintenance of the Titrino is carried out in 3 steps:

1. Testing the electronic components when the Titrino is switched on.
2. Wet-chemistry validation of the whole coulometric analysis setup
3. Maintenance and adjustment of the Titrino by Metrohm service.

6.3.1 Electronic tests

When the Titrino is switched on electronic tests are carried out. During this period **system tests** appears in the display.

The tests are documented in the system test report, which can be printed out when the Titrino is switched on (see page 8):

```
'di
798 MPT Titrino      01105  798.0010
date 2001-10-19    time 07:24
RAM test            OK
real time clock     OK
timer               OK
A/D converter       OK
LCD display         OK
COMPorts           OK
EPROM test         OK
=====
```

Contact Metrohm service if one of these tests is "not OK".

If the "real time clock" test is not ok, you can try to set date and time again. If the test is OK afterwards you should check whether your stored methods have remained unchanged.

6.3.2 Wet tests

GLP (Good Laboratory Practice) requires the periodic validation of the analytical instruments. The reproducibility and accuracy of the instruments are checked.

An annual repetition of the procedure appears to be sensible. Depending on the requirements a more frequent check may be indicated, e.g. every 3 or 6 months.

Guidelines for the testing regulations (SOP, Standard Operating Procedure) are given in the following Metrohm Application Bulletin:

No. 252: Validation of Metrohm Titrators (potentiometric) according to GLP/ISO 9001.

The validation interval can be checked by the Titrino (set under <CONFIG>, monitoring). If the interval has elapsed the Titrino displays the message **validate instrument**.

6.3.3 Maintenance and adjustment of the Titrino

The Titrino should be serviced and adjusted by Metrohm service at regular intervals.

The Titrino can check the date of the next service with the help of the monitoring function "Service" under <CONFIG>, monitoring. If this date has been passed then the Titrino will display the message **service is due**.

6.4 Warranty and conformity

6.4.1 Warranty

The warranty regarding our products is limited to rectification free of charge in our workshops of defects that can be proved to be due to material, design or manufacturing faults which appear within 12 months from the day of delivery. Transport costs are chargeable to the purchaser.

For day and night operation, the warranty is valid for 6 months.

Glass breakage in the case of electrodes or other glass parts is not covered by the warranty. Checks which are not a result of material or manufacturing faults are also charged during the warranty period. For parts of outside manufacture insofar as these constitute an appreciable part of our instrument, the warranty stipulations of the manufacturer in question apply.

With regard to the guarantee of accuracy, the technical specifications in the Instructions for Use are authoritative.

Concerning defects in material, construction or design as well as the absence of guaranteed features, the purchaser has no rights or claims except those mentioned above.

If damage of the packaging is evident on receipt of a consignment or if the goods show signs of transport damage after unpacking, the carrier must be informed immediately and a written damage report demanded. Lack of an official damage report releases METROHM from any liability to pay compensation.

If any instruments and parts have to be returned, the original packaging should be used if at all possible. This applies above all to instruments, electrodes, buret cylinders and PTFE pistons. Before embedment in wood shavings or similar material, the parts must be packed in a dustproof package (for instruments, use of a plastic bag is imperative). If open assemblies are enclosed in the scope of delivery that are sensitive to electromagnetic voltages (e.g. data interfaces etc.) these must be returned in the associated original protective packaging (e.g. conductive protective bag). (Exception: assemblies with built-in voltage source belong in a non-conductive protective packaging). For damage which arises as a result of non-compliance with these instructions, no warranty responsibility whatsoever will be accepted by METROHM.

6.4.2 EU Declaration of conformity**EU Declaration of Conformity**

The METROHM AG company, Herisau, Switzerland hereby certifies, that the instrument:

798 MPT Titrino

meets the requirements of EC Directives 89/336/EEC and 73/23/EEC.

Source of the specifications:

EN 50081	Electromagnetic compatibility, basic specification; Emitted Interference
EN 50082	Electromagnetic compatibility, basic specification; Interference Immunity
EN 61010	Safety requirements for electrical laboratory measurement and control equipment

Description of apparatus:

All-purpose titrator with LCD graphical display. Titration sequences can be programmed and methods stored on a memory card.

Herisau, October 30, 2001



Dr. J. Frank

Ch. Buchmann

Leiter Entwicklung

Leiter Produktion und
Beauftragter Qualitätssicherung

6.4.3 Certificate of Conformity and System Validation

Certificate of Conformity and System Validation

This is to certify the conformity to the standard specifications for electrical appliances and accessories, as well as to the standard specifications for security and to system validation issued by the manufacturing company.

Name of commodity:	798 MPT Titrimo
System software:	Stored in ROMs
Name of manufacturer:	Metrohm Ltd., Herisau, Switzerland

This Metrohm instrument has been built and has undergone final type testing according to the standards:

Electromagnetic compatibility
IEC61326-1

Electromagnetic compatibility: Emission
EN50081-1, EN50081-2, EN55022 (class B), IEC61000-3-2

Electromagnetic compatibility: Immunity
EN50082-1, IEC61000-6-2, Namur, IEC61000-4-2, IEC61000-4-3, ENV50204,
IEC61000-4-4, IEC61000-4-5, IEC61000-4-6, IEC61000-4-11

Safety specifications
IEC61010-1, EN61010-1, UL3101-1

It has also been certified by the Swiss Electrotechnical Association (SEV), which is member of the International Certification Body (CB/IEC).

The technical specifications are documented in the instruction manual.

The system software, stored in Read Only Memories (ROMs) has been validated in connection with standard operating procedures in respect to functionality and performance. The features of the system software are documented in the instruction manual.

Metrohm Ltd. is holder of the SQS-certificate of the quality system ISO 9001 for quality assurance in design/development, production, installation and servicing.

Herisau, October 30, 2001



Dr. J. Frank

Ch. Buchmann

Development Manager

Production and
Quality Assurance Manager

6.5 Scope of delivery and ordering designations

798 MPT Titrino2.798.0010

inclusive the following accessories:

1 Titrino	1.798.0010
1 Keypad for MPT Titrino 798	6.2132.090
1 Memory card for methods	6.2245.010
1 Key for Exchange Units	6.2739.010
1 Mains cable with cable socket, type CEE(22), V Cable plug to customer's specifications	
type SEV 12 (Switzerland...)	6.2122.020
type CEE(7), VII (Germany...)	6.2122.040
type NEMA/ASA (USA...)	6.2122.070
1 Vesuv 3.0 light, PC program for data acquisition and method backup for 2 devices	6.6008.500
1 Application card with application methods	6.6046.000
1 Instructions for Use for 798 MPT Titrino	8.798.1003
1 Quick References for 798 MPT Titrino	8.798.1013
1 Short Operating Guide for 798 MPT Titrino	8.798.1023

Options

Accessories to separate order and on payment of extra charge:

Burets

Auxiliary burets

765 Dosimat	2.765.0010
776 Dosimat	2.776.0010
Cable Titrino (activate pulse, line L6) — 765 or 776 Dosimat	6.2139.000

Exchange Units

V = 1 mL,	6.3026.110
V = 5 mL,	6.3026.150
V = 10 mL,	6.3026.210
V = 20 mL,	6.3026.220
V = 50 mL,	6.3026.250

Stirrers and Titrating Stands

728 Magnetic stirrer	2.728.0040
727 Ti Stand for rinsing and addition of fresh solvent	2.727.0010
802 Rod Stirrer	2.802.0010
727 Ti Stand with built-in magnetic stirrer	2.727.0100

Titration equipment

Titration vessel, volumes	
1... 50 mL	6.1415.110
5... 70 mL	6.1415.150
10... 90 mL, order 6.2036.000 holding ring separately	6.1415.210
20... 90 mL	6.1415.220
50... 150 mL	6.1415.250
70... 200 mL	6.1415.310
Titration vessel with thermostatic jacket, volumes	
1... 50 mL	6.1418.110
5... 70 mL	6.1418.150
20... 90 mL	6.1418.220
50... 150 mL	6.1418.250
Titration vessel lid (5 openings)	
6.1414.010	
Magnetic stirring bars, length	
12 mm.....	6.1903.010
16 mm.....	6.1903.020
25 mm.....	6.1903.030
Electrode holder	
6.2021.020	

Electrodes and accessories

comb. pH Glass electrode with SGJ, without cable	6.0233.100
comb. pH glass electrode, without cable	6.0232.100
comb. pH micro glass electrode, without cable	6.0234.100
comb. pH glass electrode with built-in T sensor, with SGJ	6.0238.000
T adapter for the connection of <u>one</u> electrode to 2 Titrimos	6.2103.100
T sensor (Pt1000) with SGJ, without cable	6.1110.100
Electrode cable, 1m	6.2104.020
Cable for T sensor.....	6.2104.080
SGJ sleeve for electrodes without SGJ.....	6.1236.040

Printers

Custom-Drucker DP40-S4N	2.140.0200
Cable Titrino – Custom DP40-S4N (9/9 pins)	6.2134.110
Cable Titrino – Seiko DPU-414.....	6.2134.110
Cable Titrino – EPSON LX300+ (9/25 pins).....	6.2134.050
Cable Titrino – HP Desk Jet (serial interface) (9/25 pins)	6.2134.050
Cable Titrino – HP Desk/Laser Jet (parallel IF)	2.145.0330
Adapter for connection of printer/balance at the same COM.....	6.2125.010+6.2125.030

Balances

For Mettler cables you need an adapter 9/25 pins	6.2125.010
Cable Sartorius – balances MP8, MC1 (9/25 pins)	6.2134.060
Cable Shimadzu – balances BX, BW	6.2125.080+6.2125.010
Ohaus Voyager, Explorer, Analytical Plus balances	cable from Ohaus
Mettler AB, AG balances (interface LC-RS25)	cable with balance
Mettler AT balance	6.2146.020+6.2125.010
Mettler AM, PM balance	6.2146.020+6.2125.010+accessories from Mettler
Mettler balances with interface 016	cable from Mettler
Mettler balances with interface 011 or 012	6.2125.020+6.2125.010
Mettler PG, AB-S balances	6.2134.110
Mettler AX, MX, UMX balances	6.2134.120
AND balances (with RS232 interface OP-03)	6.2125.020+6.2125.010
Precisa balances	6.2125.080+6.2125.010
Adapter for connection of printer/balance at the same COM	6.2125.010+6.2125.030

Connection of PC keyboard and/or barcode reader

Remote Box	6.2148.000
------------------	------------

PC connection

Cable Titrino – PC (9/9 pins)	6.2134.040
Cable Titrino – PC (9/25 pins)	6.2125.110
RS232 C extension cable (25/25 pins)	6.2125.020
RS232 C extension cable (9/9 pins)	6.2134.110
Vesuv 3.0, PC program for data acquisition and method backup for up to 64 devices	6.6008.200

Sample Changer

730 Sample Changer, 1 working station, 1 pump and 1 valve	2.730.0010
730 Sample Changer, 1 working station, 2 pumps and 2 valves	2.730.0020
730 Sample Changer, 2 working stations, 2 pumps and 2 valves	2.730.0110
730 Sample Changer, 2 working stations, 4 pumps and 4 valves	2.730.0120
760 Sample Changer, 1 working station	2.760.0010
Cable Titrino — 730, 760 Sample Changer	6.2141.020
Cable 2x Titrino — 730, 760 Sample Changer	6.2141.030
Cable Titrino — 730, 760 Sample Changer+665, 725, 765, 776 Dosimat	6.2141.040
Cable Titrino — 730, 760 Sample Changer+ 2x 665, 725, 765, 776 Dosimat	6.2141.050
Cable Titrino — Control Unit 664 for Sample Changer 673/674	3.980.3560

Index

Keys are marked with < >, **display texts** are in bold characters, and pages concerning the green part are *printed in italic*.

A

Accessories	173
activate pulse:	18, 28, 34, 36
Analog potentiometer	2
Automatic reports	44
auto start	9
auxiliaries	9

B

backup	56
balance:	8
Balance connection	153
Barcode reader	156
barcode:	9
baud rate:	10
buffer 1 pH	35
bytes missing	133

C

Cables	174f
CAL	35
Calculations	38
<CAL.DATA>	58
Calibration	36
cal.date	58
calibrate electrode	133
calibration:	7
cal.temp.	35, 58
<CARD>	55
card...	133
Certificates	171
CE	171
<C-FMLA>	40
change card battery	133
Characters input	6
check	133, 134
<CLEAR>	4
common variables	10, 43
Computer connection	155
COM X	
characteristics	126ff
configuration	10
pin assignment	129
conditioning:	27
<CONFIG>	7
Configuration	7
Conformity	170

Connection

balance	153
barcode reader	156
computer	155
electrode	159
PC keyboard	157
printer	152
remote box	156
Sample Changer	154
stirrer	151
Ti Stand	151
Connection cables	174f
Contrast of display	2
Control parameters	30
Curve	
changing output	12
display	47
example	45
printing	44
<CURVE>	47
cycle lines:	62

D

DX overload	134
data bit:	10
data lost	134
Data	
input	5, 6
output	44
reproduction	46
transfer (RS232)	67ff
data set reevaluation	134
date	9
Decimal places	39
<DEF>	38ff
delete all:	62
delete all silo lines	62
delete line n	61
delete n	41
Delete	
common variables	43
formulas	39
methods	53, 55
statistic values	41
text	6
user name	48
delete silo lines	61
DET	14ff
dev.label	10

Diagnosis.....	138
Diagnostic report.....	169
dialog:	9
Differential potentiometry.....	159
directory...	55, 56
directory already exists	134
Display, contrast.....	2
display drift:	27
division by zero	134
<DOS>.....	2
dos.rate	15
Drift.....	19, 34
drift corr:	27
drift value	27
dynamics	24

E

edit silo lines	60
electr.id	35
Electrode connection.....	159
electrode test:	16
<ENTER>.....	4
Entry of	
data.....	5
text.....	6
EP at	24
EPC	17
EP overflow	134
EP recognition:	17
EP titration.....	24
equibr.time	15, 33, 35
Error messages.....	73, 133
error XX	137
evaluation	17
Exchange Unit.....	173
extr.time	26

F

Fabrication number.....	3
factor	15, 16
Filling rate	
after determination.....	16
after manual dosing.....	2
fix EP	18
formula	38

G

General rules for RS232.....	67ff
Graphics	
changing output.....	12
display.....	47
example.....	45
printing.....	44

H

handshake:	10
Handshake.....	126
Hardware handshake.....	128

I

id#1 or C21	59
Identification.....	59
request.....	17
info	50
Initialize RAM.....	149
Input of	
values.....	5
text.....	6
Inquiries.....	5
I/O lines.....	165f
I(pol)	16
ISO.....	172

K

Keyboard, PC.....	157
keyboard:	9
Keypad.....	4
Keys	
<ABC>.....	6
<CAL.DATA>.....	58
<CARD>.....	55
<C-FMLA>.....	40
<CLEAR>.....	4
<CONFIG>.....	7
<CURVE>.....	47
<DEF>.....	38ff
<DOS>.....	2
<ENTER>.....	4
<MEAS/HOLD>.....	4
<MODE>.....	13
<PARAM>.....	14ff
<PRINT>.....	46
<QUIT>.....	4
<REPORTS>.....	46
<SILO>.....	60
<SMPL DATA>.....	59ff
<START>.....	4
<STATISTICS>.....	41
<STOP>.....	4
<USER>.....	48
<USER METH>.....	53

L

LX output:	50
LED.....	2
limit smpl size:	18
Lock functions.....	11
low lim.	17, 18, 39

M

Mains 3, 164
 Malfunctions 73, 133ff
man.reports to COM: 8
 Manual operation 4ff
manual stop 134
match id: 64
 Maximum/minimum evaluation 23
max.rate 24
mean n 41
 Mean values
 calculation 41
 delete results 42
 report 44
 silo 64
 MEAS 33
 <MEAS/HOLD> 4
meas.input: 8, 16, 26, 33, 35, 37
meas.pt.density 14
meas.pt list overflow 134
measured quantity: 13, 37
measuring parameters 33
 Measuring point list printing 44
 Memory card 55
 MET 14ff
method: 49, 53, 55
 Method name 53
 Minimum/maximum evaluation 23
min.incr. 14
min.rate 24
missing... 134
 <MODE> 13
 Mode
 CAL 35
 DET 14
 MEAS 33
 MET 14
 SET 24
 TIP 37
 Mode selection 13
monitoring 7
 Monitoring
 calibration interval 7
 result limits 39
 sample size limits 18
 service interval 8
 validation 7

N

name: 48
next service 8
no. 134, 135
 Non-aqueous titrations 159
not possible 135
not valid 135

O

Object tree 77
 Ordering designations 173
 Outputs 165f
outside 135
overrange 135

P

Parameters
 CAL 35
 DET 14
 MEAS 33
 MET 14
 SET 24
 TIP 37
 <PARAM> 14ff
parity: 10
pause (X) 16, 25
 PC keyboard 157
peripheral units 8
pH(as) 58
 pH(init) 39
 Pin assignment
 "Remote" socket 165f
 RS232 129
pK/HNP: 18
 Power connection 3, 164
preselections 18, 27, 34, 37
 <PRINT> 46
 Printer
 connection 152
 problems 131
 selection 8
 Problems
 printer 131
 SET titrations 32
program 10

Q
 <QUIT> 4

R

RAM, initialize 149
recall method 53, 55
reload 56
 Remote box 156
remote box: 9
 Remote control
 via "Remote" lines 165f
 via RS232 67ff
report COMX: 44
 Report
 printing 44, 46
 reproduction 46
 selection 44

<REPORTS>	46	silos lines	61
req.ident:	18	Silo reports	46, 64
req.smpl size:	18	slope	58
res.tab:	41	<SMPL DATA>	59ff
Result		smpl unit:	59
calculation	38	Software handshake	126
delete	41	Special messages	133ff
display	10	<START>	4
report	44	start delay	9
store	63	start V	15, 25
text	39	<STATISTICS>	4, 41
result display:	10	statistics	41
result out of limits	135	Statistics calculations	41
RS1 decimal places	39	Statistics values	
RS1 limit control:	39	delete results	42
RS1 text	39	report	45
RS1 unit:	39	silo	64
RS232 settings COMX	10	Stirrer connection	151
RS232 interface		stirrer:	38
characteristics	126ff	stirrer control:	9
configuration	10	<STOP>	4
pin assignment	129	stop bit:	10
run number	9	stop conditions	16, 27
S		stop crit:	25
same buffer	135	stop drift	25
sample size out	135	stop EP	17
save lines:	62	stop pH	17
save lines off	135	stop... reached	135
Sample changer	154	stop time	25
sample changer:	35	stop V	16, 27
Sample identification	59	Store	
Sample size	59	methods	53, 55
Scope of delivery	173	results	63
second TIP call	135	Submethods in TIP	52
Selection of		Survey	2
balance	8	system error XX	135
printer	8	System test report	169
send to COMX:	8	system test report:	8
Sequence		T	
CAL	36	Technical specifications	162
DET	19	t(delay)	25
MET	19	temperature	16, 26, 34, 37
SET	29	temporary variables	52
TIP	51	Text input	6
Serial number	3	time	9
service:	8	time counter	7, 8
service is due	135	time interval	7, 8, 26, 34
SET	24ff	time-out PC keyboard	136
SET X	24	TIP	49ff
Setting up	151ff	TIP terminated	136
signal drift	15, 33, 35	Titration	
<SILO>	60	problems	32
silos calculations	64	vessel	161
silos empty	135		
silos full	135		

Titration curve	
changing output	12
display.....	47
example	45
printing.....	44
Titration modes	14
Titration parameters	
DET	14
MET	14
SET	24
Titration sequence	
DET	19
MET	19
SET	29
TIP	51
titr.direction:	25
transmission error	136
Tree	77
U	
Unit	
result	39
sample	59
up lim.	17, 18, 39
U(pol)	16
<USER>.....	48
<USER METH>.....	53
User	
methods.....	53, 55
name.....	48
V	
validate instrument	136
validation:	9
Validation.....	169
Values input.....	5, 6
V step	14
W	
Warranty	170
wrong card	136
wrong sample	136