



CH-9101 Herisau/Switzerland

E-Mail info@metrohm.com

Internet www.metrohm.com

795 KFT Titrino

Program version 5.795.0010

Instructions for Use

Table of contents

1 Introduction	1
1.1 Instrument description	1
1.2 Controls and parts	2
2 Manual operation	6
2.1 Keypad.....	6
2.2 Principle of data input	7
2.3 Text input	8
2.4 Configuration, key <CONFIG>	9
2.5 Key <MODE>	14
2.6 Parameters, key <PARAM>.....	15
2.6.1 Parameters for KFT	15
2.7 Result calculations.....	25
2.8 Statistics calculation	28
2.9 Common variables.....	30
2.10 Data output	31
2.10.1 Reports for the output at the end of a determination.....	31
2.10.2 Display of the Curve.....	33
2.11 User name, key <USER>	34
2.12 Method memory key <USER METH>	35
2.13 Current sample data, key <SMPL DATA>	37
2.14 Silo memory for sample data.....	38
2.15 Storing determination results and silo calculations	41
2.15.1 Storing determination results	41
2.15.2 Silo calculations	42
2.16 Manual dosing	44
3 Operation via RS232 Interface	45
3.1 General rules.....	45
3.1.1 Call up of objects	46
3.1.2 Triggers	47
3.1.3 Status messages	48
3.1.4 Error messages.....	49
3.2 Remote control commands	52
3.2.1 Overview.....	52
3.2.2 Description of the remote control commands	67
3.3 Properties of the RS 232 Interface	90
3.3.1 Handshake.....	90
3.3.2 Pin Assignment	93
3.3.3 What can you do if the data transfer does not work?	95
4 Error messages and Troubleshooting	97
4.1 Error and special messages	97
4.2 Diagnosis	100
4.2.1 General.....	100
4.2.2 Procedure.....	100
4.2.3 Equipment required:	101
4.2.4 Diagnosis steps	101

4.3 Initialize and test RAM	110
4.4 Releasing a locked spindle	111
5 Preparations	112
5.1 Setting up and connecting the instruments	112
5.1.1 Titrino with Stirrer or Titration Stand	112
5.1.2 Connection of a printer	113
5.1.3 Connection of a balance.....	114
5.1.4 Connection of a KF Oven	115
5.1.5 Connection of a Sample Changer	116
5.1.6 Connection of the 774 Oven Sample Processor	117
5.1.7 Connection of a computer	118
5.1.8 Connection of a Remote Box.....	118
5.2 Connection of electrodes and preparing titration vessel.....	122
6 Appendix	123
6.1 Technical specifications	123
6.2 Pin assignment of the "Remote" socket.....	125
6.2.1 Lines of the "Remote" socket during the titration	127
6.2.2 Possible configurations of the activate pulse KFT.....	128
6.3 User methods	129
6.3.1 General	129
6.3.2 KF Titer determination with H ₂ O or methanol standard "H2OTiter"	130
6.3.3 KF Titer determination with sodium tartrate "TarTiter"	131
6.3.4 Blank determination for KFT "Blank_KF"	132
6.3.5 KF-titration with blank value subtraction "KF-Blank"	133
6.3.6 KF-titration without blank value subtraction "KF"	135
6.3.7 KF titrations with various KF reagents	137
6.3.8 Determination of the bromine number "BrNumber"	138
6.4 Titrino validation.....	139
6.4.1 Electronic tests	139
6.4.2 Wet tests	139
6.4.3 Maintenance and adjustment of the Titrino	139
6.5 Warranty and conformity	140
6.5.1 Warranty.....	140
6.5.2 EU Declaration of conformity.....	141
6.5.3 Certificate of Conformity and System Validation	142
6.6 Scope of delivery and ordering designations.....	143
Index.....	147

1 Introduction

1.1 Instrument description

The 795 KFT Titrino is a fast and precise Titrator for the water determination according to Karl Fischer. The 795 KFT Titrino is equipped with a LCD graphical display on which titration curves can be observed in real-time.

Ready-to-start methods for the most common applications are stored in the internal method memory. The operator is free to modify and overwrite this methods or to create and store his own titration sequences.

Data exchange with a PC is possible with the Metrodata VESUV Software and with Metrodata TiNet Software complete remote control, data acquisition and evaluation via PC is enabled.



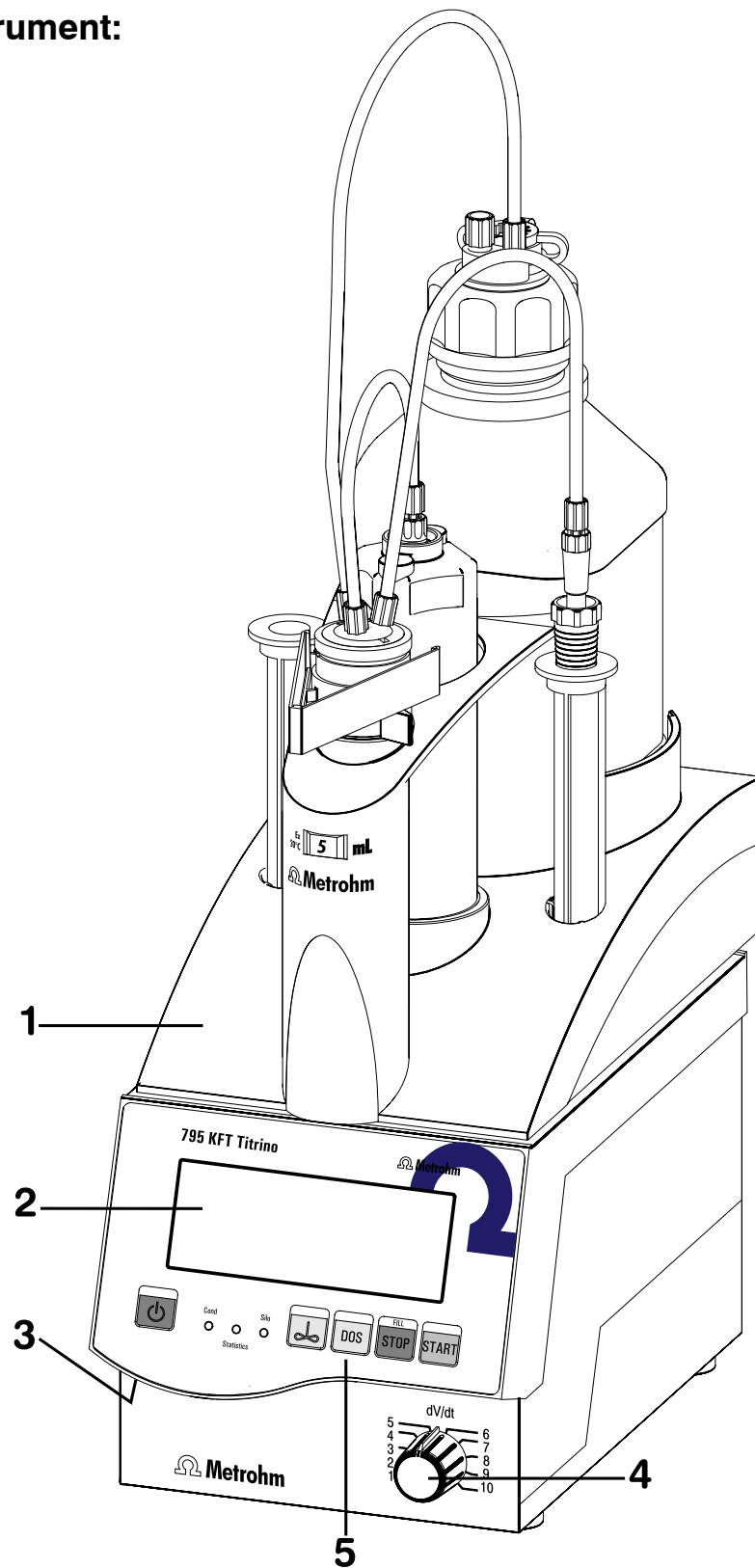

1.2 Controls and parts

Front view of instrument:



- 1 Exchange Unit**
- 2 Display**
- 3 Setting of display contrast**
- 4 Controls the dosing rate during manual dosing with <DOS> and subsequent filling**
- 5 Control keys and indicator lamps on the Titrino**

Key <  >	Power switch
Key <  >	Switching stirrer ON/OFF
Key <DOS>	Dosing key. Dispensing is performed as long as <DOS> is being pressed. Used e.g. to prepare the Exchange Unit. The dispensing rate can be set with potentiometer (5) .
Key <STOP/FILL>	- Stops procedures, e.g. titrations, conditioning. - Filling after manual dosing with <DOS>.
Key <START>	Starts procedures, e.g. titrations, conditioning. Identical with key <START> of the separate keypad.
Indicator lamps:	
"COND."	Lamp flashes when conditioning is performed and the titration vessel is still wet. It is on if conditioning is ok.
"STATISTICS"	Lamp is on when the "statistics" function (calculation of mean and standard deviation) is on.
"SILO"	Lamp is on when silo memory (for sample data) is on.

Rear view of instrument:

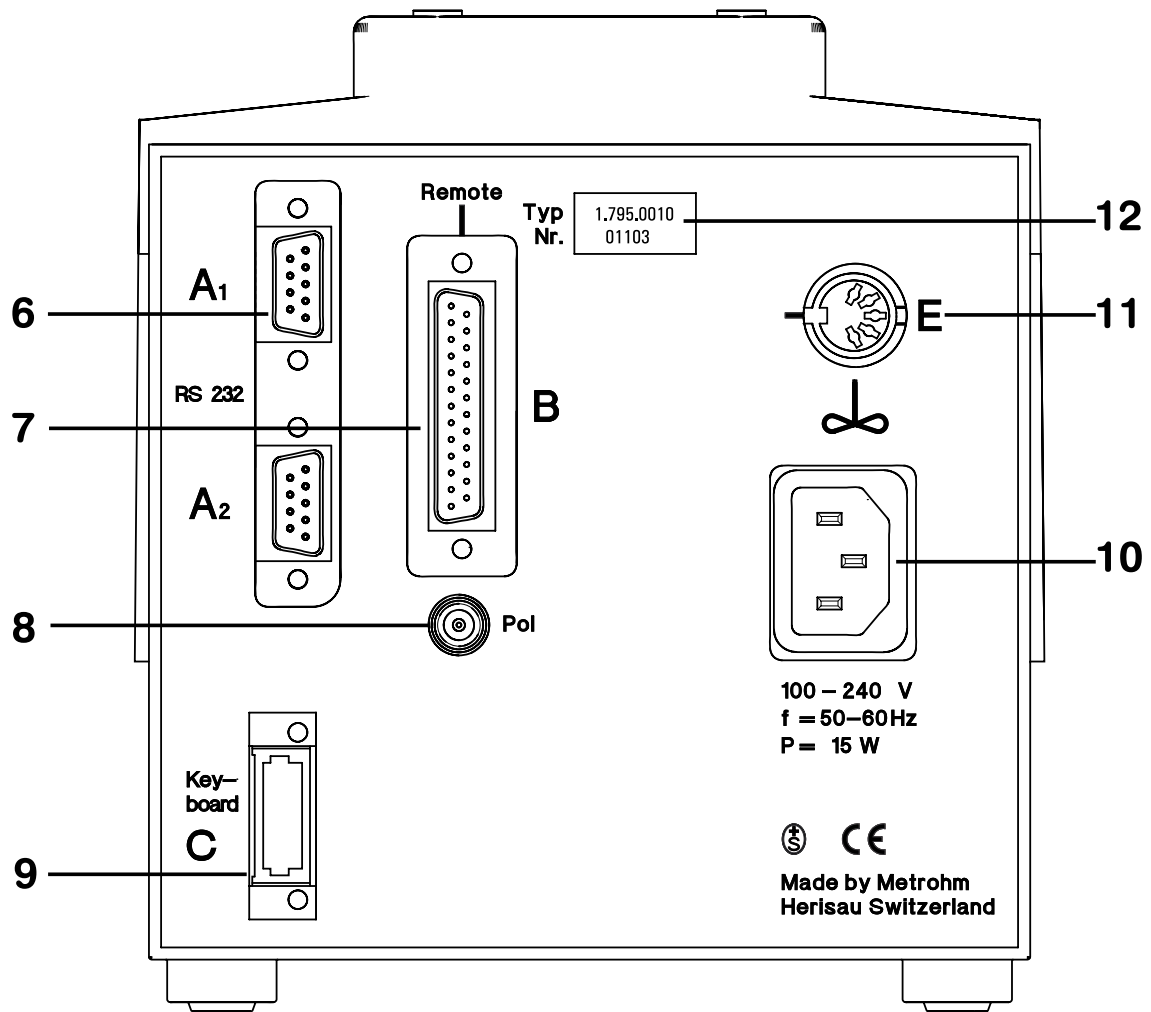

- 6** **RS232 interfaces**
2 separate interfaces for the connection of printer, balance, and computer
- 7** **Remote lines** (input/output)
for the connection of the Remote Box, Sample Changers, robots etc.
- 8** **Connection of electrodes**
• 1 measuring input for polarized electrodes, e.g. KF electrode
- 9** **Connection for separate keypad**
- 10** **Connection for power cable**
With power supplies where the voltage is subject to severe HF disturbances, the Titrino should be operated via an additional power filter, e.g. Metrohm 615 model.
- 11** **Connection for stirrer**
728 Magnetic Stirrer, 802 Rod Stirrer, 703 or 727 Ti Stand
Supply voltage: 10 VDC ($I \leq 200$ mA)
- 12** **Rating plate**
with fabrication, series and instrument number

2 Manual operation

2.1 Keypad

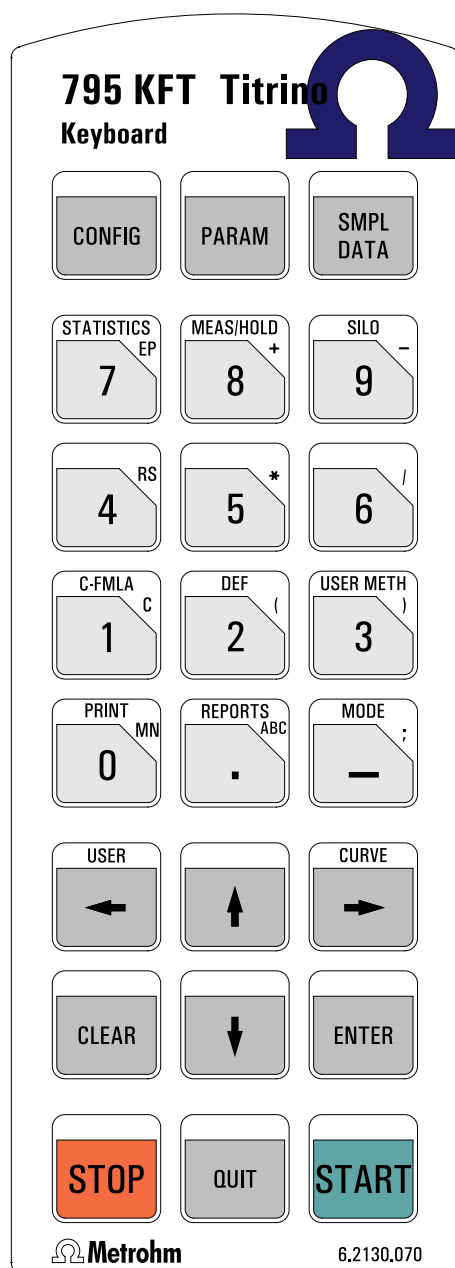

CONFIG	Configuration.
PARAM	Parameters.
SMPL DATA	Sample data.
STATISTICS	ON/OFF switching of statistics calculations of consecutive determination, see page 28.
MEAS/HOLD	ON/OFF switching of measurements between titrations and hold during titrations.
SILO	ON/OFF switching of silo memory for sample data, see page 38.
C-FMLA	Calculation values, see page 27.
DEF	Formulas, data output, see page 25ff.
USER METH	Management of internal method memory, see page 35.
PRINT	Printing of reports, see page 33.
REPORTS	Result output.
MODE	Mode dialogue, see page 14.
USER	User name, see page 34.
CURVE	Switching result/curve display, see page 33.
←, →	Selection of special values (dialog marked with " : ").
↑, ↓	Cursor key for navigation.
CLEAR	Clears values, set special values.
ENTER	Stores values.
STOP	Stops methods.
QUIT	Quits inquiries, waiting times, printing.
START	Starts methods.

The third functions (inscriptions in the triangle) on the keys of the keypad are used for formula entry, see page 25.

2.2 Principle of data input

```

configuration
>monitoring
>peripheral units
>auxiliaries
>RS232 settings COM1
>RS232 settings COM2
>common variables
    
```

```

configuration
>peripheral units
  send to COM1:      IBM
  send to COM2:      IBM
  man.reports to COM: 1
  balance:           Sartorius
  stirrer control:    OFF
  remote box:         OFF
    
```

```

configuration
>monitoring
>peripheral units
>auxiliaries
>RS232 settings COM1
>RS232 settings COM2
>common variables
    
```

- If you press a key, you will find a group of inquiries in the display.
Example key <CONFIG>:
In the first line you see where you are: You pressed key <CONFIG> and you are now in the inquiries "configuration".
- The cursor is inverted. In our example the cursor is on the inquiry ">monitoring". You can move the cursor up and down with keys <↑> and <↓>.
- If a dialog text is marked with ">", it contains a group of inquiries itself. You go to this group pressing <ENTER>.
Example inquiries of "peripheral units":
The first two lines indicate again where you are. Then you find the inquiries.
If a dialog text of an inquiry is marked with ":", you can select a value with keys <←> and <→> (forward/backward).
- A value is stored with <ENTER> and the cursor moves to the next inquiry.
- With key <QUIT> you move one level up, in our example you go back to ">peripheral units".
If you press <QUIT> once more, you quit the inquiries in "configuration" altogether.
- If you can scroll, "↓" or "↑" appear in the right lower or upper corner of the display.

2.3 Text input

Example storing a method:

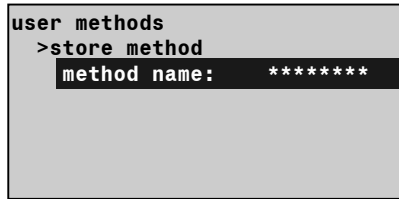

- Press key <USER METH>. Place the cursor to ">store method" and press <ENTER>. The name of the method which is currently in the working memory is displayed.

<CLEAR>

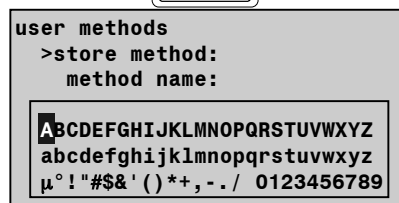
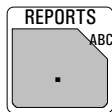

- Delete this name with <CLEAR>.
- Open the "text writing mode" with key <ABC>. You can now select the desired character by means of the cursor keys, then confirm this character. Select the next character... When you confirmed the last character, i.e. your name is complete, you quit the text writing mode with <QUIT>. Confirm now the name with <ENTER>.

<QUIT>

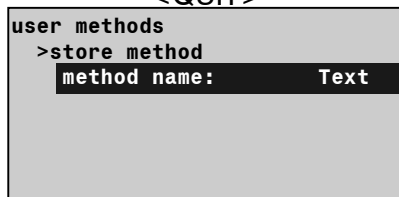

- During text input you can correct typing errors with <CLEAR>: <CLEAR> deletes the characters one by one.
- If you wish to modify an existing name, do not delete the existing name before you start the text input mode. Proceed then as follows:
 1. Press <USER METH>, place the cursor to ">store method" and press <ENTER>.
 2. Open the text writing mode directly: Press key <ABC>.
 3. <CLEAR> now deletes the characters one by one or you can add additional characters.
 4. If your text is complete, leave the text writing mode with <QUIT> and confirm the text with <ENTER>.

<ENTER>

2.4 Configuration, key <CONFIG>

<div style="text-align: center; border: 1px solid black; width: 60px; margin: 0 auto; padding: 5px;">CONFIG</div> <pre style="background-color: #f0f0f0; padding: 5px; border: 1px solid black;"> configuration >monitoring >peripheral units >auxiliaries >RS232 settings COM1 >RS232 settings COM2 >common variables </pre>	<p>Key <CONFIG> serves to enter device specific data. The set values apply to all modes.</p> <p>monitoring: Monitoring of instrument validation, service interval and printout of diagnostic report.</p> <p>peripheral units: Selection of printer, balance, stirrer control and COM for manual report output.</p> <p>auxiliaries: e.g. setting of dialog language, date, time, type of result display.</p> <p>RS232 settings COM1 and 2: RS parameters for the COM's.</p> <p>common variables: Values of common variables.</p> <p>The display texts of the Titrimo are shown on the left side. The values are the default values.</p>
<pre style="background-color: #f0f0f0; padding: 5px; border: 1px solid black;"> >monitoring validation: OFF time interval 365 d time counter 0 d service: OFF next service YYYY-MM-DD </pre>	<p>Monitoring functions</p> <p><i>Monitoring the validation interval (ON, OFF)</i> Monitoring is carried out at the end of the titrations and when the Titrimo is switched on. If the monitoring responds the message "validate instrument" appears. The message vanishes with <CLEAR>. At the same time the counter is reset to zero.</p> <p>If "ON" has been set: <i>Time interval for validation (1...9999 d)</i> see also page 139.</p> <p><i>Time counter (0...9999 d)</i> Counts the number of days since the last time the counter was reset.</p> <p><i>Monitoring the service interval (ON, OFF)</i> Monitoring is carried out after the Titrimo has been switched on. If the monitoring responds the message "Service is due" appears. The message vanishes with <CLEAR>.</p> <p>If "ON" has been set: <i>Date of next service (YYYY-MM-DD)</i></p>

system test report:	OFF	<p><i>System test report printout (ON, OFF)</i></p> <p>With "ON" the report of the system test is printed out after the Titrino has been switched on, see also page 139.</p>
>peripheral units		Settings for peripheral units
send to COM1:	IBM	<p><i>Selection of printer (Epson, Seiko, Citizen, HP, IBM) at the Titrino COM1</i></p>
send to COM2:	IBM	<p>"Epson", for Epson "Seiko", e.g. for DPU-414 "Citizen", e.g. for iDP 562 RS, Custom DP40-S4N "HP" e.g. for Desk Jet types. Place curves always at the beginning of a page as you cannot have them over 2 pages. "IBM" for all printers with IBM character set Table 437 and IBM graphics, as well as for the data transmission to a computer or a data system.</p>
man.reports to COM:	1	<p><i>COM of Titrino for the output of manually triggered reports (1, 2, 1&2)</i></p> <p>Manually triggered reports (e.g. with <PRINT> ...). Exception <PRINT><REPORTS>: These reports are outputted on the COM as defined in the method.</p>
balance:	Sartorius	<p><i>Selection of balance (Sartorius, Mettler, Mettler AT, AND, Precisa)</i></p> <p>Sartorius: Models MP8, MC1 Mettler: Models AM, PM, AX, MX, UMX and balances with 011, 012, and 016 interfaces Mettler AT: Model AT AND: Models ER-60, 120, 180, 182, FR-200, 300 and FX-200, 300, 320 Precisa: Models with RS232C interface</p>
stirrer control:	OFF	<p><i>Automatic switching ON/OFF of the stirrer in the titration sequence (ON, OFF)</i></p> <p>If stirrer control is ON, the stirrer will be switched on at the beginning and switched OFF at the end of a determination. For KFT with conditioning the stirrer will be switched off in the inactive state. For stirrer control the red switch on the stirrer unit must be ON.</p>
remote box:	OFF	<p><i>Connection of a remote box (ON, OFF)</i></p> <p>To the remote socket for PC keyboard and barcode reader, see page 118.</p>
keyboard:	US	<p>If "ON" has been set: <i>Type of PC keyboard (US, German, French, Spanish, Swiss.)</i> The PC keyboard is used as an input aid, see page 119.</p>

barcode:	input	<p>Target for barcode reader (input, method, id1, id2, id3, smpl size)</p> <p>The barcode reader is used as an input aid, see page 118.</p> <p>Input: The barcode string goes to the entry field in which the cursor is currently located.</p> <p>Method: The barcode string goes to the entry field "Methods" in the silo memory.</p> <p>Id1: The barcode string goes to the entry field "Id1". (Similar for Id2 and Id3.)</p> <p>Smpl size: The barcode string goes to the entry field "smpl size".</p>
>auxiliaries		General settings
dialog:	english	<p>Selection of dialog language (english, deutsch, français, español, italiano, portugese, svenska)</p>
date	2001-11-15	<p>Current date (YYYY-MM-DD)</p> <p>Format: Year-month-day, entry with leading zeros.</p>
time	08:13	<p>Current time (hh-mm)</p> <p>Format: Hours-minutes, entry with leading zeros.</p>
run number	0	<p>Current run number for result output (0...9999)</p> <p>The sample number is set to 0 when the instrument is switched on and incremented on every determination.</p>
auto start	OFF	<p>Automatic start of titrations. (1...9999, OFF)</p> <p>Number of automatic starts ("number of samples"). Used for instrument interconnections in which the external instrument does not initiate a start. Not advisable in connections with Sample Changers.</p>
start delay	0 s	<p>Start delay (0...999999 s)</p> <p>Delay time after start of methods. Abort start delay time with <QUIT>.</p>
result display:	bold	<p>Type of result display at the end of the determination (bold, standard)</p> <p>bold: The calculated results are displayed in bold characters.</p> <p>standard: Displays the whole information, e.g. results, endpoints, messages etc.</p>
dev.label.		<p>Individual identification of devices (up to 8 ASCII characters)</p> <p>Will be printed in the result report, see page 32.</p>
program	795.0010	<p>Display of program version</p>

<p>>RS232 settings COM1</p> <p>baud rate: 9600</p> <p>data bit: 8</p> <p>stop bit: 1</p> <p>parity: none</p> <p>handshake: HwS</p>	<p>Settings of RS232 interface see also page 90 Identical for COM2.</p> <p><i>Baud rate (300, 600, 1200, 2400, 4800, 9600, 19200, 38400, 57600, 115200)</i></p> <p><i>Data bit (7, 8)</i></p> <p><i>Stop bit (1, 2)</i></p> <p><i>Parity (even, odd, none)</i></p> <p><i>Handshake (HwS, SWline, SWchar, none)</i> see page 90.</p>
<p>>common variables</p> <p>C30 0.0</p> <p>etc.</p>	<p>Values of the common variables</p> <p><i>Common variables C30...C39 (0.. ± 999999)</i> The values of all common variables are displayed. For creating common variables see page 30.</p>

Settings with key <CONFIG> and power ON

Proceed as follows:

1. Switch the Titrino OFF.
2. Press <CONFIG> and keep it pressed during switching the Titrino ON.
The display shows the following:

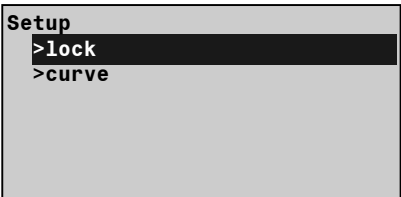
	<p>lock: Locking keys <CONFIG>, <PARAM> and <SMPL DATA>, and the functions "recall method", "store method" and "delete method" of the internal method memory in the Titrino.</p> <p>curve: Changes the appearance of the curve printout.</p>
<p>>lock</p> <p><configuration>: OFF</p> <p><parameters>: OFF</p> <p><smpl data>: OFF</p> <p>recall method: OFF</p> <p>store method: OFF</p> <p>delete method: OFF</p>	<p>lock "ON" means that the corresponding function is not accessible anymore.</p> <p>The corresponding key is locked.</p> <p>The corresponding function in the internal method memory of the Titrino is locked.</p>

<p>>curve</p>	<p>curve</p> <p>The settings are valid for COM1 and COM2. If you change the printer type, the following settings are initialized according to the printer.</p>										
<p>grid: ON</p>	<p><i>Grid drawing (ON, OFF)</i></p>										
<p>frame: ON</p>	<p><i>Frame drawing (ON, OFF)</i></p>										
<p>scaling: Full</p>	<p><i>Type of scaling (Full, Auto)</i> Full: The scaling goes from the greatest to the smallest value. auto: The scaling from tick to tick, e.g. the smallest/greatest values lie in between the first/last tick.</p>										
<p>width 0.5</p>	<p><i>Width (0.2...1.00)</i> 1 is greatest width. If you set 1, you may loose the label at the right margin.</p>										
<p>length 0.05</p>	<p><i>Length (0.01...1.00)</i> <i>Time axis:</i></p> <table style="margin-left: 40px;"> <tr> <td></td> <td>Curve length</td> </tr> <tr> <td>0.01</td> <td>100 cm</td> </tr> <tr> <td>0.1</td> <td>10 cm</td> </tr> <tr> <td>0.5</td> <td>2 cm</td> </tr> <tr> <td>1</td> <td>1 cm</td> </tr> </table>		Curve length	0.01	100 cm	0.1	10 cm	0.5	2 cm	1	1 cm
	Curve length										
0.01	100 cm										
0.1	10 cm										
0.5	2 cm										
1	1 cm										

2.5 Key <MODE>

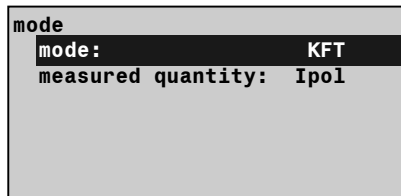
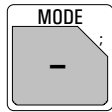

With the key <MODE> the dialogue „mode“ is opened.

The 795 Titrino is a titrator, specially designed for Karl Fischer water determinations. It has exclusively the mode KFT (**K**arl **F**ischer **T**itration).

With <ENTER> the selection of the measured quantity is activated. Select Ipol or Upol with <←> or <→> and confirm it also with <enter>.

The following modes can be selected:

- KFT: **K**arl **F**ischer **T**itration, the determination of water content.

The mode KFT is equipped with a set of standard parameters. They only need few settings in order to be ready to work.

2.6 Parameters, key <PARAM>

	<p>The key <PARAM> is used for the entry of values that determine the modes. Values marked with "cond." are accessible during the conditioning in the KFT mode. "**titr." means that these values can be changed during the titration. They influence the ongoing determination. Other values can only be changed in the inactive state.</p> <p>The display texts of the Titrino are shown on the left side. The values are the default values.</p>
---	---

2.6.1 Parameters for KFT

<pre> parameters >control parameters >titration parameters >stop conditions >statistics >preselections </pre>	<p>control parameters: for the EP.</p> <p>titration parameters control the general course of the titration.</p> <p>stop conditions: Parameters for the termination of the titration.</p> <p>statistics: Calculation of mean values and standard deviation, see page 28.</p> <p>preselections: ON/OFF of various auxiliary functions such as automatic requests after the start and activate pulse.</p>
<pre> >control parameters EP at U 250 mV cond. dynamics 100 mV **titr. </pre>	<p>Control parameters</p> <p><i>Endpoint (input range depending on the measured quantity:</i> <i>U, Ipol: 0.. ±2000 mV</i> <i>I, Upol: 0...±200.0 µA)</i></p> <p><i>Control (input range depends on the measured quantity:</i> <i>U, Ipol: 1...2000 mV</i> <i>I, Upol: 0.1...200.0 µA)</i> Outside of the control range: constant dosing, see page 21.</p>

max.rate **titr.	max. ml/min	<p><i>Maximum dosing rate (0.01...150 mL/min, max.)</i> <CLEAR> sets "max." This parameter determines primarily the addition rate outside the control range, see page 21. The maximum rate depends on the Exchange Unit:</p> <table border="1"> <thead> <tr> <th>Exchange Unit</th> <th>max. rate</th> </tr> </thead> <tbody> <tr> <td>5 mL</td> <td>15 mL/min</td> </tr> <tr> <td>10 mL</td> <td>30 mL/min</td> </tr> <tr> <td>20 mL</td> <td>60 mL/min</td> </tr> <tr> <td>50 mL</td> <td>150 mL/min</td> </tr> </tbody> </table>	Exchange Unit	max. rate	5 mL	15 mL/min	10 mL	30 mL/min	20 mL	60 mL/min	50 mL	150 mL/min
Exchange Unit	max. rate											
5 mL	15 mL/min											
10 mL	30 mL/min											
20 mL	60 mL/min											
50 mL	150 mL/min											
min.volume incr. **titr.	min. µl	<p><i>Minimum volume increment (0.1...9.9 µL, min.)</i> <CLEAR> sets "min." This parameter determines the addition rate at the start and the end of the titration, see also page 21. This parameter influences the titration speed and therefore its accuracy very strongly: A smaller "min.volume incr." results in a slower titration.</p>										
stop crit: **titr.	drift	<i>Type of stop criteria (drift, time)</i>										
stop drift **titr.	20 µl/min	<i>Titration stops, if EP and stop drift are reached (1...999 µL/min)</i>										
t(delay) **titr.	10 s	<p><i>Titration stops if there is no dosing during t(delay) (0...999 s, INF)</i> <CLEAR> sets "INF". Switch off when EP is reached and the set time after the last dosing has elapsed.</p>										
stop time **titr.	OFF s	<p>If t(delay) is "INF" <i>Stop after a time (0...999999 s, OFF)</i> <CLEAR> sets "OFF". Stop after the set time after start of titration. "OFF" means no stop, i.e. titration for an "infinitely" long time.</p>										
>titration parameters		Titration parameters										
titr.direction:	-	<p><i>Direction is set automatically (+, -, auto)</i> auto: The direction is set automatically by the Titrino. +: Direction of higher voltage (more "positive"), larger currents. -: Direction of lower voltage, smaller currents.</p>										
pause 1 **titr.	0 s	<p><i>Pause 1 (0...999999 s)</i> Waiting time before start volume, e.g. for equilibration of the electrode after start. The waiting time can be aborted with <QUIT>.</p>										

start V: <i>cond.</i>	OFF	<i>Type of start volume (OFF, abs., rel.) "OFF": start volume switched off "abs.": absolute start volume in mL "rel.": relative start volume to sample size.</i>
start V <i>cond.</i>	0.0 mL	If "abs." is set: <i>Absolute start volume (0...999.99 mL)</i>
factor <i>cond.</i>	0	If "rel." is set: <i>Factor for relative start volume (0...±999999). Calculated as: start V in mL = factor * sample size</i>
dos.rate **titr.	max. mL/min	<i>Dosing rate for start volume (0.01...150 mL/min, max.) <CLEAR> sets "max." The maximum rate depends on the Exchange Unit: Exchange Unit max. rate 5 mL 15 mL/min 10 mL 30 mL/min 20 mL 60 mL/min 50 mL 150 mL/min</i>
pause 2 **titr.	0 s	<i>Pause 2 (0...999999 s) Waiting time after start volume, e.g. reaction time after dosing of a start volume. The waiting time can be aborted with <QUIT>.</i>
extr.time **titr.	0 s	<i>Extraction time (0...999999 s) During this time the titration is running. It will not be stopped (also if EP is already reached), before the extraction time is terminated. The extraction time can be aborted with <QUIT>.</i>
I(pol)	50 µA	<i>Polarization current (−127...127 µA) or the polarization potential (−1270...1270 mV, in steps of 10 mV) is inquired.</i>
U(pol)	400 mV	
electrode test:	OFF	<i>Electrode test (OFF, ON) Test for polarized electrodes. Performed on changeover from the inactive standby state to a measurement. "OFF" means that the test is not performed.</i>
temperature <i>cond.</i>	25.0 °C	<i>Titration temperature (−170.0...500.0 °C). The temperature can be entered manually.</i>
time interval <i>cond.</i>	2 s	<i>Time interval (1...999999 s) Time interval for acquisition of a measured value into the measuring point list.</i>

>stop conditions		<p>Stop conditions for titration If this is not "normal", i.e. after reaching the EP</p>										
stop V: **titr.	abs.	<p><i>Type of stop volume (abs., rel., OFF)</i> "abs.": absolute stop volume in mL "rel.": relative stop volume to sample size "OFF": stop volume switched off. Stop volume is not monitored. The stop volume applies for one single titration. The conditioning volume is not monitored.</p>										
stop V **titr.	99.99 mL	<p>If "abs." is set: <i>Absolute stop volume (0...9999.99 mL)</i></p>										
factor **titr.	999999	<p>If "rel." is set: <i>Factor for relative stop volume (0...±999999)</i> Calculated as: Stop V in mL = factor * sample size</p>										
filling rate max. mL/min **titr.		<p><i>Filling rate after titration (0.01...150 mL/min, max.)</i> <CLEAR> sets "max." The maximum rate depends on the Exchange Unit:</p> <table border="1"> <thead> <tr> <th>Exchange Unit</th> <th>max. rate</th> </tr> </thead> <tbody> <tr> <td>5 mL</td> <td>15 mL/min</td> </tr> <tr> <td>10 mL</td> <td>30 mL/min</td> </tr> <tr> <td>20 mL</td> <td>60 mL/min</td> </tr> <tr> <td>50 mL</td> <td>150 mL/min</td> </tr> </tbody> </table>	Exchange Unit	max. rate	5 mL	15 mL/min	10 mL	30 mL/min	20 mL	60 mL/min	50 mL	150 mL/min
Exchange Unit	max. rate											
5 mL	15 mL/min											
10 mL	30 mL/min											
20 mL	60 mL/min											
50 mL	150 mL/min											
>preselections		<p>Preselections for the sequence</p>										
conditioning:	ON	<p><i>Automatic conditioning of titration vessel (ON, OFF)</i> If conditioning is "ON", the solution is constantly kept at the endpoint. When conditioning is performed, the volume drift can be displayed during the conditioning:</p>										
display drift: cond.	ON	<p><i>Display of drift during conditioning (ON, OFF).</i> Volume drift.</p>										
drift corr: cond.	OFF	<p><i>Type of drift correction (auto, man., OFF)</i> Type of drift correction: (EP – drift * time) auto: drift value at start is valid man.: see below OFF : no correction</p>										
drift value cond.	0.0 µL/min	<p><i>Value for manual drift correction (0.0...99.9 µL/min)</i></p>										
req.ident: cond.	OFF	<p><i>Request of identifications after start of titration (id1, id1&2, all, OFF)</i> After start, sample identifications can be requested automatically: Only id1, id1 & id2, all three id's or no inquiries.</p>										

req.smpl size: cond.	OFF	<i>Request of sample size after start of titration (value, unit, all, OFF)</i> "all" the value and the unit will be requested.
limit smpl size: cond.	OFF	<i>Limiting value check for sample size (ON, OFF)</i> With "ON" the error message "sample size out." appears if the entry is outside the set limits. The limiting values are shown in the display window. The absolute value of the limit is checked during sample size input and during the calculation of the results.
low lim. cond.	0.0	If "ON" has been set: <i>Lower limit for sample size (0.0...999 999)</i>
up lim. cond.	999999	<i>Upper limit for sample size (0.0...999 999)</i>
oven: cond.	no	<i>Connected oven (COM1, COM2, no)</i> COM of the Titrino to which the oven is connected. If an oven is connected via RS232 an inquiry will be made for the oven results and these will be inserted into the result report of the Titrino. The report output on the oven must be switched OFF (see also page 115). Set "no" if no oven has been connected or if you have not connected the oven to Titrino the via RS232 interface.
activate pulse: cond.	OFF	<i>Pulse output on I/O line L6 (L6, pin 1) of the remote socket (first, all, cond., OFF) e.g. start of a Dosimat, see page 126.</i>

Titration sequence of KFT

<START>	After the start, the activate pulse is outputted and the stirrer switched on.
(Activate pulse) (Stirrer ON)	
(Start delay)	The start delay time is waited off.
(Preconditioning) <START> (Activate pulse) (Start delay)	If conditioning is on, the sample solution is titrated until the EP is reached. The display shows then drift OK 2.3 µl/min or KFT conditioning The vessel is now conditioned. The titration can be started with <START>.
(Request ident.) (Request smpl size)	The sample identifications and the sample size are requested.
(Start conditions)	Pause 1 is waited off, the start volume is dispensed and pause 2 waited off.
(Extraction time) Titration with test of stop criterion	The titration is executed. If the extraction time is not yet over when the endpoint has been reached, the titration will only be terminated after the extraction time is over.
(Stirrer OFF)	The stirrer is switched off when there is no conditioning.
Calculations	Calculations are carried out.
Data output	Data are outputted.
(Reconditioning)	Conditioning is carried out.

Control parameters for KFT

The control parameters can be set according to your samples. The default parameters are already set to get satisfactory results. Optimize the control parameters for specific samples only.

During the titration, reagent dosing is carried out in 3 phases:

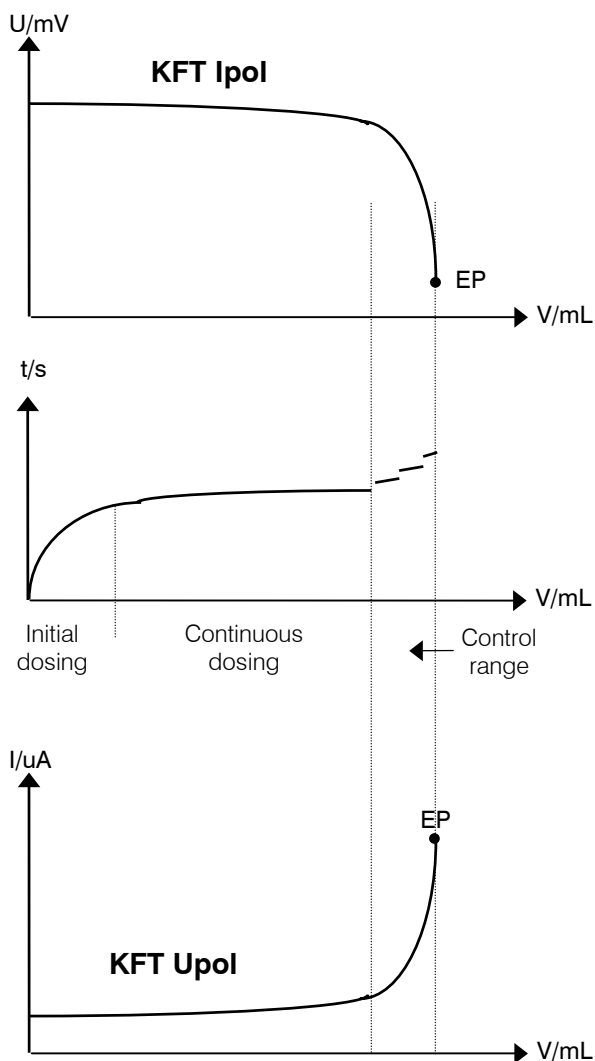

1. Initial dosing:
Here the dosing rate increases constantly up to "max.rate".
2. Continuous dosing:
Dosing is performed at the maximum rate "max.rate" until the control range (dynamics) is reached.
3. Control range (dynamics):
In this range, dosing is performed in single steps. The last dosing steps are controlled by the parameter "min.volume incr.".

Remarks:

- Titer determination should have the same modes and the same parameters as the sample titrations.
- In most cases the preset default parameters provide precise and reproducible results.
- Ipol gives relatively steep curves. They are flatter with Upol.

Mechanisms of the KFT parameters in Ipol mode

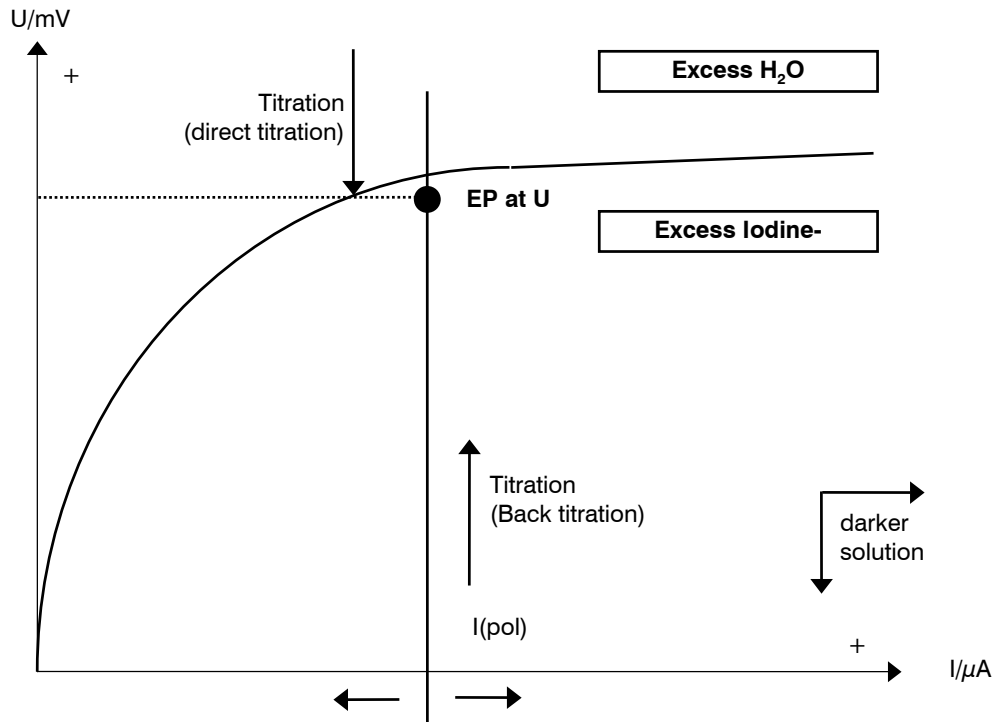

- The position and curve characteristics of the line between the ranges of excess water or excess iodine depends on the type of sample and the ingredients of the working media.
- The endpoint has to be set close to the range margin, but always within the iodine excess range. If the endpoint is set too close to the limit, an overdose of KF reagent may be dispensed. The steeper the curve at the preset polarization current $I(\text{pol})$, the more delicate it is to titrate to a steady and reproducible endpoint. For the titration of troublesome samples, the particular conditions must be optimized by trial and error. Always mind the color of the working medium at the end point as your guideline.
Remark: In most cases the preset default parameters provide precise and reproducible results.
- If you select negative values for a parameter, you should choose negative values for all other parameters too in order to have compatible parameter sets.
- In KFT Upol mode, all parameters work in a similar manner as in KFT Ipol mode.

The determination of the free water is easily done, as far as the specifications of the reagent manufacturer regarding the "water capacity" of the reagents are considered. Problems may occur with specific sample matrices. The relevant literature contains many precise analysis instructions. Here, we give you some useful hints for the sample addition.

Sample addition

For sample addition various accessories are available, for example injection syringes, weighing spoons etc.

It is a good idea to apply the back-weighing technique, except when you are disposing small amounts of liquids with a micro-syringe. Fill the syringe or the weighing spoon with your sample just before the titration (e.g. during conditioning) and tare it on a balance with an appropriate precision, which ideally is connected to the Titrino. Sample size request should always be switched on (see page 19). Add the sample during the request for the sample size, and weigh the syringe or weighing spoon again to evaluate the weight difference. Use the transfer of balance data to enter the correct sample size if possible. The weight has to be transmitted in gram. If you transfer the sample size from the balance, the sample size request is confirmed automatically, and the titration is started at once. Otherwise use the keypad to enter the weight.

If the sample size request is switched off, and preconditioning is set, you are explicitly prompted to add your sample. For six seconds, the message "add sample" is displayed after which the titration is started by the Titrino itself. This waiting time can be extended by pressing <MEAS/HOLD>.

Solid samples

Use the glass weighing spoon 6.2412.000 and dispose the sample through the opening for the septum stopper.

Liquid samples

Use a disposable syringe (2...20 mL) or a micro-syringe with a long needle attached. Puncture the septum and dispose the sample carefully. When using disposable syringes, add the liquid sample carefully without dipping into the solvent. Draw back the last drop of sample into the syringe before you redraw the needle. For disposing an exact, small volume of liquid sample, use a micro-syringe. Proceed as described above, but dip the needle into the preconditioned solvent and dispose the sample carefully. Here drawing back of solvent or sample adhering to the needle is not recommended. Always keep in mind to exchange the septum as soon as it shows any large punctures impairing the tightness of the titration cell.

Pasty, viscous samples

For samples which cannot be disposed with a needle because of their high viscosity, you can handle your samples with disposable syringes with a large volume without using a needle. Dispose your sample through the opening of the septum stopper. Back-weigh the syringe after addition of the sample. Be sure to wipe off any adhering excess sample substance of the syringe before taring it.

In any case, pay attention to prevent the penetration of atmospheric moisture into the titration vessel when you are disposing the sample. If you still have to open the titration cell for any reason, determine a blank value and take it into account for the calculation of the titration result (see page 132).

In the following table we attempt to show you solutions related more to the instrument's side:

What to do if ...

Problem	Possible causes and remedial action
Dosing at end too long and increments too small. "Is never finished!"	<ul style="list-style-type: none"> • Increase "min.volume incr." • Change stop criterion. Try to increase stop drift or use a short stopping time as stop criterion, e.g. • For problematic samples change solvents with ketones or aldehydes in 2-methoxyethanol or with amines mixture in methanol/glacial acetic, e.g., see literature.
The increments at the end of the titration are too large. "Overshoots".	<ul style="list-style-type: none"> • Lower "max.rate". The following experiment gives you a reference point for the optimum max.rate: Drift display during conditioning and add sample without starting the titration. Select a value below the maximum drift as "max.rate". • Optimize setup of electrode and buret tip and improve stirring.
Solution becomes too brown at the end of the titration.	<ul style="list-style-type: none"> • The methanol fraction in the solvent is too low. Change the solvent. • Electrode could be coated; wipe off with acetone.
Solution becomes darker with every titration.	<ul style="list-style-type: none"> • Renew solvent. • Electrode could be coated; wipe off with acetone.
The drift increases with every titration.	<ul style="list-style-type: none"> • Does your sample evolve water extremely sluggishly? Work with the KF oven. • Are acids esterified in your sample? Change solution more frequently. Increase buffer capacity of the solvent. • Does your sample contain ketones or aldehydes? Use special reagents suitable for ketones and aldehydes.
The endpoint is reached "too rapidly".	<ul style="list-style-type: none"> • Reduce "max.rate".
The titration times become longer and longer.	<ul style="list-style-type: none"> • With 2-component reagents the buffer capacity of the solvent can be exhausted. Change solution. • If the drift increases at the same time, see above.

2.7 Result calculations

Formula entry, key <DEF>

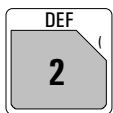
 <pre>def >formula >silo calculations >common variables >report >mean</pre>	<p>Key <DEF> contains various inquiries for result calculations and data output. The data of this key are method specific and they are stored in the method memory together with the method.</p> <p>formula: Formulas for result calculations.</p> <p>The display texts of the Titrino are shown on the left side. The values are the default values.</p>
<pre>>formula RS? RS1= RS1=EP1*C01 / C00</pre>	<p>Input of formulas</p> <p><i>Enter formula number (1...9)</i> You can calculate up to 9 results per method. Enter a number 1...9.</p> <p><i>Input of formula</i> Example: RS1=EP1*C01/C00 Enter formula by means of 3rd functions of keyboard. Here you will find operands, mathematical operations and parentheses. Operands require a number as an identification. You can use the following operands: EPX: EP's. X = 1...9 RSX: Results which have already been calculated with previous formulas. X = 1...9 CXX: Calculation constants. XX = 00...45</p> <p>Rules:</p> <ul style="list-style-type: none"> • Calculation operations are performed in the algebraic hierarchy: * and / before + and -. • Store formula with <ENTER>. • Calculation quantities and operands can be deleted with <CLEAR> one by one. • To delete a complete formula press <CLEAR> repeatedly until only RSX remains in the display. Confirm with <ENTER>. <p>If a formula is stored with <ENTER>, result text, number of decimals, result unit and the settings of the result limit control will be requested:</p>

RS1 text	RS1	<i>Text for result output (up to 8 characters)</i> Text input see page 8.
RS1 decimal places	2	<i>Number of decimal places for result (0..5)</i>
RS1 unit:	%	<i>Selection of result unit (% , ppm, g/L, mg/mL, mol/L, mmol/L, g, mg, mL, mg/pc, s, mL/min, no unit or up to 6 characters).</i>
RS1 limit control:	OFF	<i>Limit control for the result (ON, OFF)</i> The limits are checked each time a result is calculated.
RS1 low lim.	0.0	If "ON" has been set: <i>Lower limit (0.0...999 999)</i>
RS1 up lim.	0.0	<i>Upper limit (0.0...999 999)</i>
RS1 L13 output:	OFF	<i>Sets line L13 of the remote socket (OFF, active, pulse) if the result lies outside the limits.</i>
Enter next formula, e.g. for RS2.		

Meaning of the calculation variables CXX:

C00	Sample size, see page 37.
C01...C19	Method specific operands, see page 27. They are stored with the method in the method memory.
C21...C23	Sample specific operands, see page 37ff.
C26, 27	Mean values from silo calculations, see page 41ff.
C30...C39	Common variables.
C40	Initial measured value of the sample.
C41	End volume.
C42	Determination time.
C43	Volume drift for KFT with conditioning.
C44	Temperature.
C45	Dispensed start volume.

Input of method specific operands C01...C19, key <C-FMLA>

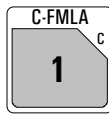

With <C-FMLA> the operands C01...C19 can be put in. For the calculation, the operands are used, which were introduced in the formula.
The inputs method specific and are store in method memory.

The calculation report can be printed with the key sequence <PRINT><←/→> (press keys repeatedly until "calc" appears in the display) <ENTER>.

Example for a calculation report:

```
'fm
795 KFT Titrimo      01103      795.0010
user                pk1
date 2001-11-15    time 15:01      3
KFT Ipol           KF-Blank
>calculations
Water=(EP1-C38)*C39*C01/C00/C02;2;%
Titer=C39;4;mg/ml
Blank=C38;4;ml
C00=                1.0
C01=                0.1
C02=                1
C38=                0.0
C39=                0.0
.....
```

Calculation report



mode und method name
formulas:
result name=formula;number of decimal places;result unit

sample size
method specific operands

values of the common variables that are used

2.8 Statistics calculation

Mean values, absolute and relative standard deviations are calculated.

 <pre>def >formula >silc calculations >common variables >report >mean</pre>	<p>The <DEF> key is used to allocate results for statistics calculation.</p> <p>The entries are specific to the method and are stored in the method memory.</p> <p>mean: Assigns values for statistics calculations.</p> <p>The display texts of the Titrino are shown on the left side. The values are the default values.</p>
<pre>>mean MN1=RS1 MN2= : MN9=</pre>	<p>Allocations for statistics calculations</p> <p><i>Number n of single values for statistics calculation. (1...9)</i></p> <p>You can perform statistics calculation using up to 9 results (RSX), endpoints (EPX) or variables (CXX). For MN1, the default value RS1 is entered.</p> <p>Delete allocation with <CLEAR> + <ENTER></p>
	<p>Each mode has an inquiry group ">statistics" in key <PARAM></p>
<pre>>statistics status: OFF mean n= 2 res.tab: original delete n= 1</pre>	<p>Statistics calculation</p> <p><i>Status of statistics calculation (OFF, ON)</i></p> <p>If the statistics calculation is switched off, the following inquiries regarding the statistics do not appear.</p> <p><i>Mean value calculation from n single results (2...20)</i></p> <p><i>Result table (original, delete n, delete all)</i></p> <p>"original": The original table is used. Deleted individual results are again incorporated in the evaluation.</p> <p>"delete n": Deletion of single results with the index n.</p> <p>"delete all": The entire table is deleted.</p> <p><i>Delete data from sample number n (1...20)</i></p> <p>The deleted result is removed from the statistics calculation.</p>

How do you obtain statistics calculations?

- 1) Enter the allocations for the statistics calculation, see page 28.
- 2) Switch on the statistics calculations: Either with <STATISTICS> or set the status under <PARAM>, "> statistics" to "ON". The "STATISTICS" LED is on. Storing a method in the method memory, the status of the statistics calculation is retained.
- 3) Change the number of the individual values n under "mean n", if necessary.
- 4) Perform at least 2 titrations. The statistics calculation are constantly updated and printed. The values are printed in the short and full result report.
- 5) The statistics report can be printed with <PRINT><STATISTICS><ENTER>.

Rules:

- Recalculated results are incorporated in the statistics calculation.
- If a result of a particular titration can not be calculated, no results for this determination are incorporated in the statistics calculation. However, the sample counter is still operative, i.e. the statistics calculation start afresh when the number of required individual determinations has been performed.
- If the statistics are switched off ("statistics" LED no longer on), results are no longer entered in the statistics table. But the table remains unchanged. When the statistics are switched on again, you can immediately continue working.
- If you delete results, all results of the determination with index n are removed from the statistics evaluation.
- On method change, the old statistics table is cleared and the statistics instructions of the new method are followed.
- Old results in the statistics table can be deleted with "delete all" (<PARAM>, "> statistics", "res.tab:").

2.9 Common variables

Common variables are used for:

- Determination of a titer with a method. This titer is stored permanently as C3X. The operand C3X can be used in various other methods like any other operand.
- Determination of a blank values with a method . Using this blank value in various other methods.
- Determination of a result with method. Reconciliation of this result in various other methods.

You may enter and view the values of the common variables with <CONFIG>.

<div style="text-align: center; border: 1px solid black; padding: 5px; width: fit-content; margin: 0 auto;"> DEF 2 </div> <pre style="background-color: #f0f0f0; padding: 5px; border: 1px solid black;"> def >formula >silc calculations >common variables >report >mean </pre>	<p>With <DEF>, results (RSX), endpoints (EPX), variables (CXX) or mean values (MNX) can be allocated as common variables. The entries are specific to the method and are stored in the method memory.</p> <p>common variables: Assigns values to common variables.</p> <p>The display texts of the Titrimo are shown on the left side. The values are the default values.</p>
<pre style="background-color: #f0f0f0; padding: 5px; border: 1px solid black;"> >common variables C30= C31 : C39= </pre>	<p>Allocation for common variables</p> <p><i>Common variable C30...C39 (RSX, EPX, CXX, MNX)</i> Results (RSX), endpoints (EPX), variables (CXX), and means (MNX) can be assigned. The values of the common variables remain in force for all methods until they are overwritten or deleted. They can be viewed under the <CONFIG> key. Delete allocation with <CLEAR> + <ENTER>.</p>

2.10 Data output

2.10.1 Reports for the output at the end of a determination

<div style="text-align: center; border: 1px solid black; padding: 5px; width: fit-content; margin: 0 auto;"> DEF 2 </div> <pre style="background-color: #f0f0f0; padding: 5px; border: 1px solid black;"> def >formula >silco calculations >common variables >report >mean </pre>	<p>With <DEF>, the report sequence at the end of the determination is defined. The entries are specific to the method and are stored in the method memory.</p> <p>report: Definition of report blocks to be printed automatically at the end of the determination.</p> <p>The display texts of the Titrimo are shown on the left side. The values are the default values.</p>
<pre style="background-color: #f0f0f0; padding: 5px; border: 1px solid black;"> >report report COM1: report COM1:full;curve </pre>	<p>Report sequence</p> <p><i>Report sequence for COM1: full, short, mplist, curve, scalc full, scalc srt, param, calc, ff</i></p> <p>Select a block using the keys <←> and <→>. If you require more than one report block, set a ";" as a delimiter between the blocks.</p> <p>Identical for COM2.</p>

Meaning of the report blocks:

- param Parameter report.
- full Full result report with raw results, calculations and statistics.
- short Short result report with calculations and statistics.
- mplist Measuring point list.
- curve Curve volume vs. time
- scalc full Full report of silo calculations.
- scalc srt Short report of silo calculations.
- calc Report with formulas and operands.
- ff Form feed on printer.

Additional possibilities for report outputs

In addition to the reports which are printed at the end of the titration, various other reports can be put out. There are 2 possibilities to select the reports:

- 1) <PRINT> <←/→> <ENTER> Cursor is pressed repeatedly until the desired report appears in the display.
- 2) <PRINT> <keyX> <ENTER> key X is the key under which the appropriate data are entered.

List of the "keys X":

Report	<Key X>
Configuration report	CONFIG
Parameter report	PARAM
Current sample data	SMPL DATA
Statistics report with the individual results	STATISTICS
All sample data from the silo memory	SILO
Operands C01...C19	C-FMLA
Contents of the <DEF> key	DEF
Contents of the method memory with details of the memory requirements of the individual methods and the remaining bytes	USER METH
Complete report sequence of the last determination, as defined under the <DEF> key in the method	REPORTS

Result display without printer

If you work without printer, we recommend to work with the standard character set for result display (settings in key <CONFIG>, ">auxiliaries", see page 11). You will get the complete information on your determinations: Calculated results, endpoints, messages etc.

2.10.2 Display of the Curve

After the titration, the curve can be viewed. Switch between "curve" and "result display" with key <CURVE>.

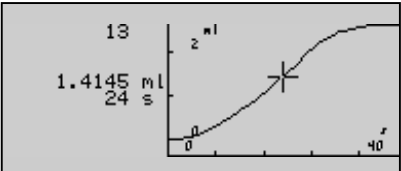
	<p>You can trace the curve with keys <↑> and <↓>. In the text field on the left side of the curve the index of the current measured value is displayed in the first line. In the subsequent lines, the corresponding measured values are shown.</p>
---	---

2.11 User name, key <USER>

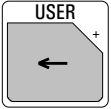
 <pre> user name: boss >delete </pre>	<p>The key <USER> manages the user names. User names can be entered directly or selected with the keys <←> and <→>.</p> <p>name: Selection or input of user name.</p> <p>delete: Delete user name.</p> <p>The display texts of the Titrino are shown below at the left.</p>
<pre> name: </pre>	<p><i>User name (up to 10 ASCII characters)</i></p> <p>User names can be entered directly or selected with the keys <←> and <→>.</p> <p>The user name is printed out in the report. The user name remains in the instrument until it is deleted (or until the RAM is initialized). If no operator name is to be printed out the user "blank" can be selected.</p>
<pre> >delete name: </pre>	<p>Delete user name</p> <p>Enter the name directly or select it with the keys <←> and <→>. <ENTER> will delete the name from the list of user names.</p>

2.12 Method memory key <USER METH>

<div style="text-align: center; border: 1px solid black; padding: 5px; width: fit-content; margin: 0 auto;"> USER METH 3 </div> <div style="border: 1px solid black; padding: 5px; margin-top: 10px;"> <pre> user methods >recall method >store method >delete method </pre> </div>	<p>Management of the internal method memory with key <USER METH>.</p> <p>Select method name with keys <←> and <→>.</p> <p>recall method: Loads a method from the internal method memory into the working memory.</p> <p>store method: Stores the method which is in the working memory in the internal method memory.</p> <p>delete method: Deletes a method from the internal method memory.</p> <p>The display texts of the Titrimo are shown on the left side. The values are the default values.</p>
<pre> >recall method method name: </pre>	<p>Recall method</p> <p><i>Recall method from the internal method memory to the working memory (input of method name, which is included in the memory).</i></p> <p>If a method identification is entered which is not found in the method memory, the selected value blinks.</p>
<pre> >store method method name: </pre>	<p>Store method</p> <p><i>Store method from the working memory to the internal method memory (up to 8 ASCII characters).</i></p> <p>If a method with an identical name is already stored, you are requested if you wish to overwrite the old method. With <ENTER> it is overwritten, with <QUIT> you return to the entry.</p>

<p>>delete method</p> <p>method name:</p>	<p>Delete method</p> <p><i>Delete method from the internal method memory (input of method name, which is included in the memory). For safety, you are again asked if you really wish to delete the method. With <ENTER> it is deleted, with <QUIT> you return to the working memory. If a method name is entered which is not found in the method memory, the selected value blinks.</i></p>
--	---

The contents of the method memory can be printed with the key sequence
<PRINT> <USER METH> <ENTER>

Document your methods (e.g. parameter report, def. report and C-fmla report)!
With a PC and the 6.6008.XXX Vesuv program, you should carry out a complete method backup periodically.

2.13 Current sample data, key <SMPL DATA>

<div style="text-align: center; border: 1px solid black; width: 60px; margin: 0 auto; padding: 2px;">SMPL DATA</div> <div style="border: 1px solid black; padding: 5px; margin-top: 10px;"> <pre> smp1 data id#1 or C21 id#2 or C22 id#3 or C23 smp1 size 1.0 g smp1 unit: g </pre> </div>	<p>The key <SMPL DATA> can be used to enter the current sample data. The content of this key changes when the silo memory is switched on, see page 39. Instead of entering the current sample data with <SMPL DATA>, you can request these data automatically after start of determinations. Configuration: <PARAM>, ">preselections". Current sample data can be entered live. For working with the silo memory see page 38.</p> <p>id#1...3 or C21...C23, sample identifications: The sample identifications can also be used as sample specific calculation variables C21...C23.</p> <p>smp1 size: Sample size. The sample size can be monitored, see e.g. page 19. The limits are then displayed in this window.</p> <p>smp1 unit: Unit of the sample size.</p> <p>The display texts of the Titrino are shown on the left side. The values are the default values.</p>
<pre> smp1 data id#1 or C21 id#2 or C22 id#3 or C23 smp1 size 1.0 g smp1 unit: g </pre>	<p>Sample data</p> <p><i>Sample identification 1...3 or sample specific operand C21...C23 (up to 8 characters).</i> Sample identifications or sample specific operands can be entered using the keypad, via a balance with a special input device or via barcode reader.</p> <p><i>Sample size (6-digit number: ±X.XXXXX)</i> Entry using keypad, via a balance or via barcode reader.</p> <p><i>Unit of sample size (g, mg, mL, µL, pc, no unit or up to 5 characters)</i> Select unit with <<-/>>.</p>

2.14 Silo memory for sample data

In the silo memory or pushup storage, sample data (method, identifications and sample size) can be stored. This is useful, e.g. when you work with Sample Changers and other automatic sample addition systems or if you wish an overview of your determination results, see page 41.



Press the key <SILO> for working with the silo memory. The status LED "silo" is on when the silo memory is switched on. The silo memory works by the FIFO principle (First In, First Out).

If the silo memory is switched on, sample data are routed to the last free line of the silo memory. If no new value is put in, the value from the last line is automatically copied. In this manner, data can be simply taken over when they remain unchanged. When the instrument is started, the sample data are fetched from the next silo line.

Organization of the silo memory

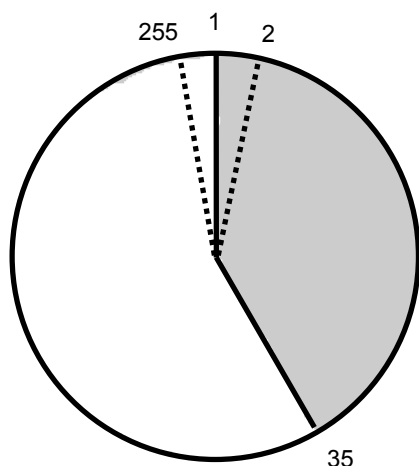

Silo memory contains 35 lines.
Next free line is 36

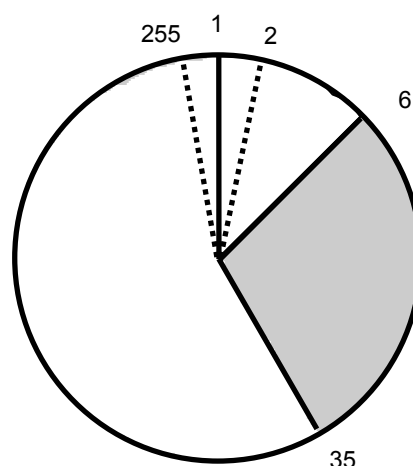

6 of the 35 lines have been processed. Free lines from 36 to 255 and from 1 to 6.

1 silo line needs between 18 and 120 bytes memory capacity.

Filling the silo memory with a connected balance

If the silo memory is filled from the balance, you must ensure that there is sufficient space in the silo memory for the required number of silo lines! The number of free bytes is given in the user memory report.

When the sample data are entered from a balance, the transfer of the sample size is taken as the end of the silo line. You should not send data from the balance and edit the silo memory at the same time.

For mixed operation, manual input of identifications and sample sizes from a balance, the values from the balance are sent into the line in which editing just takes place. Confirmed the data with <ENTER> at the Titrimo.

Key <SMPL DATA> with the silo memory switched on

<div style="text-align: center; border: 1px solid black; width: 60px; margin: 0 auto; padding: 2px;">SMPL DATA</div> <pre style="background-color: #f0f0f0; padding: 5px; border: 1px solid black;"> smp1 data >edit silo lines >delete silo lines >delete all silo lines cycle lines: OFF save lines: OFF </pre>	<p>Sample data can be entered into the silo memory with key <SMPL DATA>.</p> <p>edit silo lines: Entering sample data into the silo memory.</p> <p>delete silo lines: Deletes single silo lines.</p> <p>delete all silo lines: Deletes the whole silo memory.</p> <p>The display texts of the Titrimo are shown on the left side. The values are the default values.</p>
<pre style="background-color: #f0f0f0; padding: 5px; border: 1px solid black;"> >edit silo lines silo line 1 method: id#1 or C21 id#2 or C22 id#3 or C23 smp1 size 1.0 g smp1 unit: g </pre>	<p>Input for silo memory</p> <p><i>Silo line (1...255)</i> The next free line is displayed automatically. Lines already occupied can be corrected.</p> <p><i>Method with which the sample is processed (method name from the method memory)</i> If no method name has been entered, the sample is processed with the method in the working memory. Selection of the method with <←/→>.</p> <p><i>Sample identification 1...3 or sample specific calculation variables C21...C23 (up to 8 characters)</i></p> <p><i>Sample size (6-digit number: ±X.XXXXX)</i> The method specific limits are tested on result calculation.</p> <p><i>Unit of sample size (g, mg, mL, µL, pc, no unit or up to 5 characters)</i> Select unit with <←/→>.</p>
<pre style="background-color: #f0f0f0; padding: 5px; border: 1px solid black;"> >delete silo lines delete line n OFF </pre>	<p>Delete individual silo lines</p> <p><i>Line number of the line to be deleted (1...255, OFF)</i> <CLEAR> sets "OFF". Deleted lines remain in the silo memory. Access is blocked during the processing. To show that a line has been deleted, they are marked with "*". The symbol * indicates that the line has been deleted. Deleted lines can be reactivated if the appropriate line is re-edited.</p>

<p>>delete all silo lines</p> <p>delete all: no</p>	<p>Delete all silo lines</p> <p><i>Confirmation (yes, no)</i></p> <p>When all silo lines are deleted, the silo is completely empty: The line numbering starts again with 1.</p>
<p>cycle lines: OFF</p>	<p><i>With "ON", worked off silo lines will be copied to the highest line of the silo memory (ON, OFF)</i></p> <p>Data cycling "on" is useful if you constantly have to process the same sample data. In such a case, the processed silo line is not deleted, but copied to the next free line, see below. If you work in this mode, you should not enter any <u>new</u> silo lines during the determinations.</p>
<p>save lines: OFF</p>	<p><i>Store results in the silo memory (ON, OFF)</i></p> <p>Determination results will be stored as C24 or C25 in the silo memory according to the allocations in the methods, see page 42.</p> <p>"save lines" can only be set to "OFF" if the silo is completely empty.</p>

Silo memory with data cycling "on"

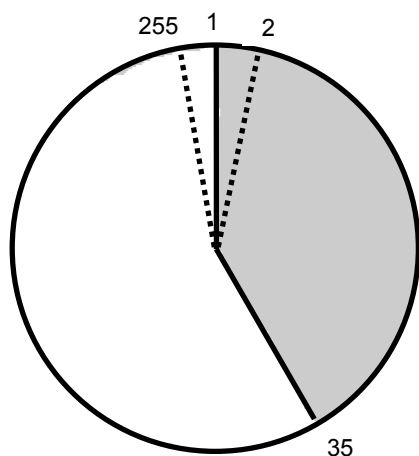

Silo memory contains 35 lines.
Next free line is 36.

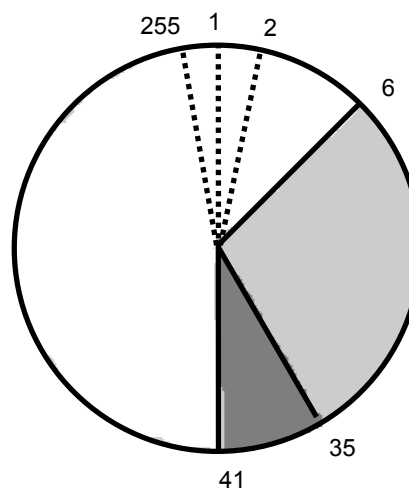

6 of 35 lines have been processed.
The processed lines have been copied to the end of the silo memory: your silo is filled up to line 41.

2.15 Storing determination results and silo calculations

2.15.1 Storing determination results

If the sample-specific data of the silo memory should be kept after the determination and supplemented by results, the following entries are necessary:

1. In the method under <DEF>
Assignment of the determination results to C24 and/or C25:
2. In the silo memory, <SMPL DATA> (when the silo memory is switched in):
"save lines: on"

Assignment of determination results

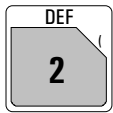
 <pre>def >formula >silo calculations >common variables >report >mean</pre>	<p>The determination results are assigned in key <DEF>.</p> <p>The display texts of the Titrino are shown on the left side.</p>
<pre>>silo calculations C24= C25=</pre>	<p>Silo calculations</p> <p>Assignment to C24 (RSX, EPX, CXX) Calculated results (RSX), endpoints (EPX) or variables CXX can be stored as C24. Same procedure for C25.</p>

Important:

Ensure that there is still sufficient space for storing the results C24 and C25. (In the report <PRINT><USER METH><ENTER> the number of free bytes is shown.) Result name, value and unit are stored. The memory requirements can be estimated as follows:

Result with text (8 characters) and unit (5 characters): 32 bytes
 Measured value C40, value without unit: 22 bytes

After several samples have been processed, the silo memory report can have the following appearance (printout with <PRINT> <SILO> <ENTER>):

← processed silo
 ← lines with
 ← saved results

The silo lines can be marked as follows (at very left of report):

- + Silo line has been processed. It cannot be edited anymore.
 - * A silo line not yet processed has been deleted.
 - A processed silo line has been deleted and hence removed from the silo calculations.
 - / The last processed silo line. Recalculation will be considered e.g., if the sample data of this line are changed.
- No marking: The silo line is awaiting processing.

For silo lines ≥ 100 , the first digit will be overwritten by the marking.

2.15.2 Silo calculations

Mean value and standard deviation of the results available in the silo memory can subsequently be calculated over the entire series.

The following details can be entered in the method under <DEF>:

>sil0 calculations	Silo calculations
C24= C25=	<i>Assignment to C24 and C25</i> Calculated results (RSX), endpoints (EPX) and variables (CXX) can be stored as C24. Identical for C25.
match id: OFF	<i>Which sample identifications must match in order to combine of the results (id1, id1&2, all, OFF)</i> "OFF" means no matching ids, all samples which have been processed with the same method are combined, see examples below.

Starting from the following silo report:

```
'si
795 KFT Titrino    01103    795.0010
date 2001-11-15   time 15:03    14
>silo
  cycle lines:      OFF
  save lines:       ON
  sl  method  id 1/C21 id 2/C22 id 3/C23  C00      C24      C25
+ 1   11-2    A/12 99-08-12    0.903g   2.6427ml  1.48% *
+ 2   0-15    A/13 99-08-12    0.010g   4.9372mg/ml  NV   Assignment
+ 3   0-15    A/13 99-08-12    0.010g   4.9786mg/ml  NV   for C24 only
+ 4   11-2    A/12 99-08-12    0.852g   2.4935ml  1.39% *
/ 5   11-2    A/15 99-08-12    0.913g   2.6720ml  1.50% *
```

with "match id: off" the following silo calculation report (scalc full) is obtained:

```
:
method  id 1/C21 id 2/C22 id 3/C23      mean      +/-s      n
  11-2      *      *      * Consum.  2.6027ml  0.0957    3
              Content  1.46%      0.06      3
  0-15      *      *      * Titer    4.9579   0.0293    2
```

All samples which have been processed with the same method are combined

With "match id: id1" the following silo calculation report (scalc full) is obtained:

```
:
method  id 1/C21 id 2/C22 id 3/C23      mean      +/-s      n
  11-2    A/12      *      * Consum.  2.5681ml  0.1055    2
              Content  1.44%      0.06      2
  0-15    A/13      *      * Titer    4.9579   0.0293    2
  11-2    A/15      *      * Consum.  2.6720ml  0.000     1
              Content  1.50%      0.000     1
```

Sample processed with the same method and having the same id1 are combined

The short silo calculation report contains only calculations for the current sample.

```
:
method  id 1/C21 id 2/C22 id 3/C23      mean      +/-s      n
  11-2    A/15      *      * Consum.  2.6720ml  0.000     1
              Content  1.50%      0.000     1
```

The mean values of the silo calculations are available for further result calculations as C26 and C27 and can be used in the Titrino in formulas.

Mean value of C24 ⇒ C26

Mean value of C25 ⇒ C27

Important:

- If work is performed with silo calculations, the method name must be entered in the silo memory.
- Results will be overwritten in the silo recalculation, as long as the silo line is marked with "/". If you do not wish such an input, e.g. because you work off an urgent sample between a series, disconnect the silo.

- Calculations and assignments are carried out in the following order:
 1. Calculation of the results RSX
 2. Calculation of means MNX
 3. Assignment of silo results C24 and C25
 4. Silo calculations
 5. Assignment of means C26 and C27 from silo calculations
 6. Assignment of common variables C3X

2.16 Manual dosing



With <DOS>, the internal buret will dose as long as <DOS> is pressed. The dosing rate can be set with the analog potentiometer at the Titrimo.

3 Operation via RS232 Interface

3.1 General rules

The Titrimo has an extensive remote control facility that allows full control of the Titrimo via the RS 232 interface, i.e. the Titrimo can receive data from an external controller or send data to an external controller. C_R and L_F are used as terminators for the data transfer. The Titrimo sends $2xC_R$ and L_F as termination of a data block, to differentiate between a data line which has C_R and L_F as terminators. The controller terminates its commands with C_R and L_F . If more than one command per line is sent by the controller, ";" is used as a separator between the individual commands.

The data are grouped logically and easy to understand. Thus e.g., for the selection of the dialog language, the following must be sent

&Config.Aux.Language "english"

whereby it is sufficient to only transmit the boldface characters, thus:

&C.A.L "english"

The quantities of the commands above are:

Config	configuration data
Aux	auxiliaries, various data
Language	setting the dialog language

The data are hierarchically structured (tree form). The quantities that occur in this tree are called **objects** in the following. The dialog language is an object which can be called up with the

&Config.Aux.Language

command.

If one is in the desired location in the tree, the value of the object can be queried.

&Config.Aux.Language \$Q Q means Query

The query command \$Q initiates the issuing of the value on the instrument and the value emission is triggered. Entries which start with \$, trigger something. They are thus called **triggers**.

Values of objects can not only be queried, they can also be modified. Values are always entered in quotes, for example:

&Config.Aux.Language "english"

3.1.1 Call up of objects

An excerpt from the object tree is represented below:

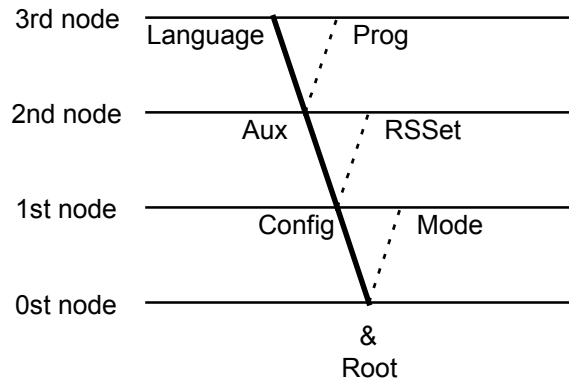

Rules	Example
The root of the tree is designated by &.	
The branches (levels) of a tree are marked with a dot (.) when calling up an object.	
When calling up an object, it is sufficient to give only as many letters as necessary to uniquely assign the object. If the call is not unequivocal, the first object in the series will be recognized.	Calling up the dialog language &Config.Aux.Language or &C.A.L
Upper- or lowercase letters may be used.	&C.A.L or &c.a.l
To an object a value can be assigned. Values are signified at the beginning and end by quotes ("). They may contain up to 24 ASCII characters.	Entering the dialog language: &C.A.L"english"
Numerical values can contain up to 6 digits, a negative sign, and a decimal point. Numbers with more than 6 characters are not accepted; more than 4 decimal places are rounded off. For numbers <1, it is necessary to enter leading zeros.	correct entry of numbers: "0.1"
	incorrect entry of numbers "1,5" or "+3" or ".1"
The current object remains until a new object is called.	entry of another dialog language: "deutsch"
New objects can be addressed relative to the old object: A preceding dot leads forwards to the next level in the tree.	From the root to node 'Aux': &C.A Forward from node 'Aux' to 'Prog': .P
More than one preceding dot leads one level backwards in the tree. n node backwards require n+1 preceding dots.	Jump from node 'Prog' to node 'Aux' and select a new object 'Language' at this level: ..L
If you must jump back to the root, enter a preceding &.	Change from node 'Language' via the root to node 'Mode': &M

3.1.2 Triggers

Triggers initiate an action on the Titrimo, for example, starting a process or sending data. Triggers are marked by the introductory symbol \$.

The following triggers are possible:

\$G	Go	Starts processes, e.g. starting the mode run or setting the RS 232 interface parameters
\$S	Stop	Stops processes
\$H	Hold	Holds processes
\$C	Continue	Continues processes after Hold
\$Q	Query	Queries all information from the current node in the tree forward up to and including the values
\$Q.P	Path	Queries the path from the root of the tree up to the current node
\$Q.H	Highest Index	Queries the number of son nodes of the current node
\$Q.N"i"	Name	Queries the name of the son node with index i , $i = 1 - n$
\$D	Detail-Info	Queries the detailed status information
\$U	qUit	Aborts the data flow of the instrument, for example, after \$Q

The triggers \$G and \$S are linked to particular objects, see the summary table page 52ff.

All other triggers can be used at any time and at all locations on the object tree.

Examples:

Querying the value of the baud rate: **&Config.RSSet.Baud \$Q**

Querying all values of the node "RSSet": **&Config.RSSet \$Q**

Querying the path of the node "RSSet": **&Config.RSSet \$Q.P**

Start mode: **&Mode \$G**

Querying the detailed status: **\$D**

3.1.3 Status messages

In order to have an efficient control by an external control device, it must also be possible to query status conditions; they provide information on the status of the Titrino. The trigger \$D initiates output of the status. Status messages consist of the global status, the detailed status and eventual error messages, e.g. \$S.Mode.KFT;E26. The global status informs on the activity of the process, while the detailed status conditions show the exact activity within the process.

The following **global status conditions** are possible:

\$G	Go:	The Titrino is executing the last command.
\$H	Hold:	The Titrino has been held (\$H, key <meas/hold> or by an error which effects the hold status).
\$C	Continue:	The Titrino has been restarted actively after hold.
\$R	Ready:	The Titrino has executed the last command and is ready.
\$S	Stop:	A process has been aborted in an "unnatural manner". e.g. stopped or aborted because there was an error.

Detailed status conditions

Status conditions of the global \$G:

\$G	.Mode.KFT	.Inac:	Instrument at the beginning or at the end of a titration.
		.Req.Id1:	Instrument in the KFT mode, requesting Id1 after start.
		.Id2:	Instrument in the KFT mode, requesting Id2 after start.
		.Id3:	Instrument in the KFT mode, requesting Id3 after start.
		.Smp1:	Instrument in the KFT mode, requesting sample size after start.
		.Unit:	Instrument in the KFT mode, requesting unit of sample size after start.
		.Start:	Instrument in the KFT mode, processing the start conditions.
		.KFT1:	Instrument in the KFT mode, titrating to the first endpoint.
		.Cond.Ok:	Instrument in the KFT, conditioning, endpoint reached (after the first startup from the standby mode).
		.Cond.Prog:	Instrument in the KFT mode, conditioning, endpoint not reached (Conditioning progressing).
\$G	.Assembly.Bur	.Fill:	Buret in filling process
		.ModeDis:	Buret in DIS mode

Status conditions of the global \$H:

The status message of the action which has been held appears.
If the process is held because a monitored limit has been violated, its status message is \$H.Mode.KFT.Titr.

Status conditions of the global \$C:

The status conditions of the global \$C are identical with the ones of the global status \$G. They appear when the process has been restarted actively from the status "Hold" (\$C, key <meas/hold> or automatically after elimination of an error).

Status conditions of the global \$R:

\$R	.Mode.KFT.QuickMeas:	Quick manual measurement from the initial status in mode KFT.	
\$R	.Mode.KFT	.Inac:	Instrument in the KFT mode, inactive.
		.Cond.Ok:	Instrument in the KFT mode, conditioning, endpoint reached.
		.Cond.Prog:	Instrument in the KFT mode, conditioning, endpoint not reached.
\$R	.Assembly.Bur	.ModeDis:	Buret in the DIS mode, inactive.

Status conditions of the global \$\$:

`$$.Mode.KFT.QuickMeas:` Quick manual measurement from the initial status in mode KFT.

The instrument gives the status from which it has been stopped. The detailed status information is therefore identical the information for the global status \$G.

Violation of monitored limits with action "end" give the status message `$$.Mode.KFT.Inac;EYYY`.

3.1.4 Error messages

Error messages are added to the status messages and separated from them by the sign ";".

E20	Check exchange unit. Exit: Mount Exchange Unit (properly) or &m \$\$.
E21	Check electrode, short circuit. Exit: Rectify fault or &m \$\$.
E22	Check electrode, break. Exit: Rectify fault or &m \$\$.
E23	Division by zero. Exit: The error message disappears on next startup or on recalculation.
E26	Manual stop. Exit: The error message disappears on next startup.
E27	Stop V reached in KFT. Exit: The error message disappears on next startup.
E28	Wrong object call up. Exit: Send correct path for object. Start path at root.
E29	Wrong value or no value allowed. Exit: Send correct value or call up new object.
E30	Wrong trigger, this trigger is not allowed or carrying-out of action not possible. Exit: Send correct trigger (exception: \$D) or call up new object.
E31	Command is not possible in active status. Repeat command in inactive status. Exit: Send new command.
E32	Command is not possible during titration. Repeat command during the conditioning phase or in inactive status. Exit: Send new command.
E33	Value has been corrected automatically. Exit: Send new command.
E34	Instrument at the end of the titration and sample data is edited; the instrument at rest or editing during filling. Exit: &m \$\$.

RS receive errors:

- E36** Parity.
Exit: <QUIT> and ensure settings of appropriate parameters at both devices are the same.
- E37** Framing error.
Exit: <QUIT> and ensure settings of appropriate parameters at both devices are the same.
- E38** Overrun error. At least 1 character could not be read.
Exit: <QUIT>
- E39** The internal working-off buffer of the Titrino is full (>82 characters).
Exit: <QUIT>

RS send errors:

- E42** CTS=OFF No proper handshake for more than 1 s.
Exit: <QUIT> Is the receiver switched on and ready to receive?
- E43** The transmission of the Titrino has been interrupted with XOFF for at least 6 s.
Exit: Send XON or <QUIT>
- E45** The receive buffer of the Titrino contains an incomplete command (L_f missing). Sending from the Titrino is therefore blocked.
Exit: Send L_f or <QUIT>.
- E121** Measuring point list overflow (more than 500 measuring points).
Exit: The error message disappears on next startup.
- E123** Missing EP for calculation.
Exit: The error message disappears on next startup or on recalculation.
- E128** No new mean.
Exit: The error message disappears on next startup or on recalculation.
- E129** No new common variable, old value remains.
Exit: The error message disappears on next startup or on recalculation.
- E130** Wrong sample. For KFT with preset titration direction the first measured value lies behind the endpoint.
Exit: The error message disappears on next startup.
- E132** Silo empty and it has been started with open silo or empty silo has been opened.
Exit: Send a silo entry.
- E133** Silo full.
Exit: Send new command.
- E137** XXX Bytes are missing so that the method or the silo line could not be stored.
Exit: Send new command.
- E155** No new silo result (C24 or C25).
Exit: The error message disappears on next start or on recalculation.

- E196** Result is out of limits.
Exit: The error message disappears on next start or on recalculation.
- E197** Sample size is out of limits.
Exit: The error message disappears on next start or on introduction of new sample size.
- E198** Validation interval is expired.
Exit: The error message disappears on next start or clear counter with &Config.Monitoring.Validation.ClearCount \$G.
- E199** Service date is reached.
Exit: The error message disappears on next start or change date in &Config.Monitoring.Service.Date.
- E203** No Oven parameters: Oven not (correctly) connected.
Exit: The error message disappears on next start. If you don't wish oven parameters in your report, select &Mode.Parameter.Presel.Oven "no" in your method(s).
- E212** Transmission error from Remote Box. Unknown characters.
Exit: Rectify error and switch Titrino off and on again.
- E213** Time-out error from PC keyboard (Remote Box)
Exit: Rectify error and switch Titrino off and on again.
- E214** Check Remote Box. Remote Box not (properly) connected but activated in &Config.Periph.RemoteBox.
Exit: Rectify error and switch Titrino off and on again.

3.2 Remote control commands

3.2.1 Overview

The internal object tree can be divided into the following branches:

&	Root
Mode	Method parameters
UserMeth	Administration of the internal user-memory for methods
Config	Instrument configuration
SmplData	Sample specific data
Hotkey	Keys with direct access
Info	Current Data
Assembly	Component data
Setup	Setting the operating mode
Diagnosis	Diagnostics program

&Mode

Object	Description	Input range	Reference
& Root			
Mode	Mode	\$G, \$\$, \$H, \$C	3.2.2.1.
. QuickMeas	Rapid meas. in basic mode	\$G, \$\$	3.2.2.2.
. Select	Mode selection	KFT	3.2.2.3.
. KFTQuantity	Measured quantity for KFT	Ipol , Upol	ditto
. Name	Name of current method	read only/read + write	3.2.2.4.
. Parameter*	Parameter of current mode, see below		
. Def	Definitions for data output		
. Formulas	Calculation formulas		
. 1	for result 1		
. Formula	Calculation formula	special	3.2.2.5.
. TextRS	Text for result output	up to 8 ASCII char	ditto
. Decimal	Number of decimal places	0...2...5	ditto
. Unit	Unit for result output	up to 6 ASCII char	ditto
. Limits	Limits for result	ON, OFF	ditto
. LoLim	Lower limit	0...±999 999	ditto
. UpLim	Upper limit	0...±999 999	ditto
. Output	Output on L13	active, pulse, OFF	ditto
:	up to 9 results		
. SiloCalc	Silo calculations		
. Assign	Assignment		
. C24	Store as variable C24	RSX,EPX,CXX	3.2.2.6.
. C25	Store as variable C25	RSX,EPX,CXX	
. MatchId	Matching of Id's	id1, id1&2, all, OFF	
. ComVar	Assignment of common variables		
. C30	for C30	RSX,EPX,CXX,MNX	3.2.2.7.
:	up to C39		
. Report	Reports at the end of determination		
. Assign1	Output to COM1	special	3.2.2.8.
. Assign2	Output to COM 2	as COM1	
. Mean	Assignment for mean calculation		
. 1	MN1		
. Assign	Input of variable	RSX, EPX, CXX	3.2.2.9.
:			
. TempVar	without meaning		
. CFmla	Calculation constants		
. 1	Calculation constant C01		
. Value	Input of value	0...±999999	3.2.2.10.
:	up to C19		

*Parameter	Tree part "Parameters for KFT"		
.CtrlPara			
Control parameters			
.EP Endpoint	depends on meas.quant.	3.2.2.11.	
.UnitEp	Unit of endpoint	read only	ditto
.Dyn	Dynamics	depends on meas.quant.	3.2.2.12.
.UnitDyn	Unit of dynamics	read only	ditto
.MaxRate	Maximum dosing rate	0.01...150, max.	ditto
.MinIncr	Minimum increment	0.1...9.9, min.	ditto
.Stop			
.Type	Type of stop criterion	drift , time	3.2.2.13.
.Drift	Stop drift	1... 20 ...999	ditto
.Time	Switch-off delay time	0... 10 ...999, inf	ditto
.StopT	Stop time	0...999999, OFF	ditto
.TitrPara			
Titration parameters			
.Direction	Titration direction	+, -, auto	3.2.2.14.
.XPause	Waiting time before start volume	0 ...999999	3.2.2.15.
.StartV			
.Type	Type of start volume	abs., rel., OFF	3.2.2.16.
.V	Volume for absolute start volume	0 ...999.99	ditto
.Factor	Factor for relative start volume	0 ...±999999	ditto
.Rate	Dispensing rate for start volume	0.01...150.0, max.	ditto
.Pause	Waiting time after start volume	0 ...999999	3.2.2.17.
.ExtrT	Extraction time	0 ...999999	3.2.2.18.
.MeasInput	without meaning		
.Ipol	Polarization current	0... 50 ...±127	3.2.2.19.
.Upol	Polarization voltage	0... 400 ...±1270	ditto
.PoIElectrTest	Test for polarized electrodes	ON, OFF	ditto
.Temp	Titration temperature	-170.0... 25.0 ...500.0	3.2.2.20.
.TDelta	Time interv. for meas.acquisition	1... 2 ...999999	3.2.2.21.
.StopCond			
Stop conditions			
.VStop	Stop volume		
.Type	Type of stop volume	abs. , rel., OFF	3.2.2.22.
.V	Volume for absolute stop volume	0... 99.99 ...9999.99	ditto
.Factor	Factor for relative stop volume	0...± 999999	ditto
.FillRate	Filling rate	0.01...150.0, max.	3.2.2.23.
.Statistics			
Statistics			
.Status	Status of statistics calculation	ON, OFF	3.2.2.24.
.MeanN	No. of individual determinations	2 ...20	ditto
.ResTab			
.Select	Result table	original , delete n, delete all	ditto
.DelN	Deletion of individual results	1 ...20	ditto
.Presel			
Preselections			
.Cond	Conditioning	ON , OFF	3.2.2.25.
.DriftDisp	Display of drift during cond.	ON , OFF	ditto
.DCor			
.Type	Type of drift acquisition	auto, man., OFF	ditto
.Value	Drift value for manual drift corr.	0.0 ...99.9	ditto
.IReq	Request of Id's after start	id1, id1&2, all, OFF	3.2.2.26.
.SReq	Request of smpl size after start	value, unit, all, OFF	ditto
.LimSmplSize			
.Status	Limits for sample size		3.2.2.27.
.Status	Status of limit control	ON, OFF	ditto
.LoLim	Lower limit	0.0 ...999 999	ditto
.UpLim	Upper limit	0.0... 999 999	ditto
.Oven	KF Oven connected	COM1, COM2, no	3.2.2.28.
.ActPulse	Output of a pulse	first, all, cond., OFF	3.2.2.29.

	"Configuration", continuation		
- .RSset1	Settings RS232, 1	\$G	3.2.2.49.
- .Baud	Baud rate	300,600,1200,2400,4800, 9600 ,19200,38400,57600, 115200	ditto
- .DataBit	Number of data bits	7, 8	ditto
- .StopBit	Number of stop bits	1 , 2	ditto
- .Parity	Parity	even, odd, none	ditto
- .Handsh	Handshake	HWs , SWchar, SWline, none	ditto
- .RSset2	as for RS1		
- .ComVar	Values of common variables		
- .C30	C30	0... ±999999	3.2.2.50.
- up to C39	0... ±999999		

"Info", continuation			
.StatisticsVal	Statistics values		
.ActN	Number of results in chart	read only	3.2.2.64.
.1	1 st mean		
.Mean	Mean	read only	ditto
.Std	Absolute standard deviation	read only	ditto
.RelStd	Relative standard deviation	read only	ditto
	up to 9 mean values		
.SiloCalc	Values of silo calculations		
.C24	Values of variable C24		
.Name	Name	read only	3.2.2.65.
.Value	Value	read only	ditto
.Unit	Unit	read only	ditto
.C25	as for C24		
.C26	Values of variable C26		
.ActN	Number of single values	read only	ditto
.Mean	Mean value	read only	ditto
.Std	Absolute standard deviation	read only	ditto
.RelStd	Relative standard deviation	read only	ditto
.C27	as for C26		
.ActualInfo	Current data		
.Inputs	I/O Inputs		
.Status	Line status	read only	3.2.2.66.
.Change	Change of line status	read only	ditto
.Clear	Clear change	\$G	ditto
.Outputs	as for I/O Inputs		
.Assembly	From Assembly		
.CyclNo	Cycle number	read only	3.2.2.67.
.Counter	Assembly counter	read only	3.2.2.68.
.V	Volume counter	read only	ditto
.Clear	Clears counter	\$G	ditto
.Meas	Measured value	read only	3.2.2.69.
.Titrator	From Titrator		
.CyclNo	Cycle number	read only	3.2.2.70.
.V	Volume	read only	ditto
.Meas	Measured indicator voltage	read only	ditto
.dVdt	Volume drift dV/dt	read only	ditto
.dMeasdt	Measured value drift	read only	ditto
.dMeasdV	1st deviation of titration curve	read only	ditto
.MeasPt	Entry in measuring point list		
.Index	Index of entry	read only	3.2.2.71.
.X	X coordinate	read only	ditto
.Y	Y coordinate	read only	ditto
.Z1	Z1 coordinate	read only	ditto
.Z2	Z2 coordinate	read only	ditto
.EP	EP entry		
.Index	Index of entry	read only	ditto
.X	X coordinate	read only	ditto
.Y	Y coordinate	read only	ditto

	"Info", continuation		
-	.Oven	Oven data	
-	.HeatTime	Heating time	read only 3.2.2.72.
-	.SampleTemp	Sample temperature	read only ditto
-	.LowTemp	Lowest temperature	read only ditto
-	.HighTemp	Highest temperature	read only ditto
-	.GasFlow	Gas flow	read only ditto
-	.UnitFlow	Unit of gas flow	read only ditto
-	.Display	Display	
-	.L1	Text line 1	up to 32 ASCII char 3.2.2.73.
-	up to line 8		
-	.DelAll	Delete display	\$G ditto
-	.Comport	Comport	
-	.Number	COM where PC is connected	read only 3.2.2.74.
-	.Assembly	Assembly	
-	.CycleTime	Cycle time	read only 3.2.2.75.
-	.ExV	Volume of Exchange/Dosing unit	read only ditto

&Assembly

Object	Description	Input range	Reference
& Root			
·			
- Assembly	Assembly control		
- Bur	Buret		
- .Rates	Rates		
- .Forward	Forward rate		
- .Select	Type of rate control	digital, analog	3.2.2.76.
- .Digital	Digital rate	0...150, max.	ditto
- .Reverse	as for forward rate		
- .Select	Type of rate control	digital, analog	ditto
- .Digital	Digital rate	0...150, max.	ditto
- .Fill	Fill	\$G,\$H,\$C	3.2.2.77.
- .ModeDis	Dispensing	\$G,\$S,\$H,\$C	3.2.2.78.
- .Select	Type of dispensing control	volume , time	ditto
- .V	Volume to be dispensed	0.0001... 0.1 ...9999	ditto
- .Time	Time to dispense	0.25... 1 ...86 400	ditto
- .VStop	Limit volume	0.0001...9999, OFF	ditto
- .AutoFill	Filling after each increment	ON, OFF	ditto
- .Meas	Measuring		
- .Status	Measuring ON/OFF	ON, OFF	3.2.2.79.
- .MeasInput	Selection of measuring input	lpol, Upol	ditto
- .Ipol	Polarization current	0... 1 ...±127	ditto
- .Upol	Polarization voltage	0... 400 ...±1270	ditto
- .Outputs	I/O outputs		
- .AutoEOD	Automatic output of EOD	ON , OFF	3.2.2.80.
- .SetLines	Set I/O lines	\$G	ditto
- .LO	Signal on LO	active,inactive,pulse, OFF	ditto
- up to L13			
- .ResetLines	Reset I/O lines	\$G	ditto
- .Stirrer	Stirrer	ON, OFF	3.2.2.81.

&Setup

Object	Description	Input range	Reference
& Root			
.			
- Setup			
Settings for the operating mode			
- .Comport	Output of automatic info	1,2,1&2	3.2.2.82.
- .Keycode	Send key code	ON, OFF	3.2.2.83.
- .Tree	Sending format of path info		
- .Short	Short format of path	ON, OFF	3.2.2.84.
- .ChangedOnly	Paths of modified nodes only	ON, OFF	ditto
- .Trace	Message on changed values	ON, OFF	3.2.2.85.
Lock key functions			
- .Lock			
- .Keyboard	Lock all keyboard keys	ON, OFF	3.2.2.86.
- .Config	Lock <CONFIG> key	ON, OFF	ditto
- .Parameter	Lock <PARAM> key	ON, OFF	ditto
- .SmplData	Lock <SMPL DATA> key	ON, OFF	ditto
- .UserMeth	Lock functions		
- .Recall	Lock "loading"	ON, OFF	ditto
- .Store	Lock "saving"	ON, OFF	ditto
- .Delete	Lock "deletion"	ON, OFF	ditto
- .Display	Lock display function	ON, OFF	ditto
Setting waiting intervals			
- .Mode			
- .StartWait	Waiting time after start	ON, OFF	3.2.2.87.
- .FinWait	Waiting time after run	ON, OFF	ditto
Automatic sending of measured values			
- .SendMeas			
- .SendStatus	Connect/disconnect sending	ON, OFF	3.2.2.88.
- .Interval	Time interval	0.08...4...16200, MPList	ditto
- .Select	Selection	Assembly, Titration	3.2.2.89.
- .Assembly	From assembly		
- .CyclNo	Cycle number	ON, OFF	3.2.2.90.
- .V	Volume	ON, OFF	ditto
- .Meas	Measured indicator voltage	ON, OFF	ditto
- .Titration	From Titration		
- .CyclNo	Cycle number	ON, OFF	3.2.2.91.
- .V	Volume	ON, OFF	ditto
- .Meas	Measured indicator voltage	ON, OFF	ditto
- .dVdt	Volume drift dV/dt	ON, OFF	ditto
- .dMeasdt	Measured value drift	ON, OFF	ditto
- .dMeasdV	1st deviation of titration curve	ON, OFF	ditto

	"Setup", continuation		
.AutolInfo	Automatic message for changes		3.2.2.92.
.Status	Switch AutolInfo on/off	ON, OFF	ditto
.P	When mains is switched on	ON, OFF	ditto
.T	Titrator infos		
.R	When "ready"	ON, OFF	ditto
.G	When method started	ON, OFF	ditto
.GC	When start is initiated	ON, OFF	ditto
.S	When stopped	ON, OFF	ditto
.B	Begin of method	ON, OFF	ditto
.F	End of process	ON, OFF	ditto
.E	Error	ON, OFF	ditto
.H	When "hold"	ON, OFF	ditto
.C	Continue after "hold"	ON, OFF	ditto
.O	Conditioning OK	ON, OFF	ditto
.N	Conditioning not OK	ON, OFF	ditto
.Re	Request after start	ON, OFF	ditto
.Si	Silo empty	ON, OFF	ditto
.M	Entry in measuring point list	ON, OFF	ditto
.EP	Entry in EP list	ON, OFF	ditto
.RC	Recalculation of results done	ON, OFF	ditto
.C	Comport infos		
.B1	When COM1 sends a report	ON, OFF	ditto
.R1	When COM1 is ready again	ON, OFF	ditto
.B2	When COM2 sends a report	ON, OFF	ditto
.R2	When COM2 is ready again	ON, OFF	ditto
.I	Changing an I/O input	ON, OFF	ditto
.O	Changing an I/O output	ON, OFF	ditto
.Graphics	Changing the curve output		
.Grid	Grid on curve	ON, OFF	3.2.2.93.
.Frame	Frame on curve	ON, OFF	ditto
.Scale	Type of depending axis	Full, Auto	ditto
.Recorder	Length of axes		
.Right	Length of meas value axis	0.2... 0.5 ...1.00	ditto
.Feed	Length of paper drive axis	0.01... 0.05 ...1.00	ditto
.PowerOn	RESET (power on)	\$G	3.2.2.94.
.Initialise	Set default values	\$G	3.2.2.95.
.Select	Selection of branch	ActMeth, Config, Silo, Assembly, Setup, All	ditto
.RamInit	Initialization of working mem.	\$G	3.2.2.96.
.InstrNo	Device Identification	\$G	3.2.2.97.
.Value	Input of device identification	8 ASCII characters	ditto

&Diagnose

Object	Description	Input range	Reference
& Root . ├ Diagnose └ .Report	Diagnose Output of adjustment parameters	\$G	3.2.2.98.

3.2.2 Description of the remote control commands

3.2.2.1. Mode \$G, \$\$, \$H, \$C
 Start and stop (\$G, \$\$) or hold of the current method (3.2.2.3) with \$H and continue with \$C.

\$G also serves to continue after inquiries of identifications and sample size after the start (see 3.2.2.26).

3.2.2.2. Mode.QuickMeas \$G, \$\$
 Start and stop of a measurement in the basic mode with the parameters (measured quantity, measuring input) of the current method. Corresponds to the <meas/hold> key.

With an ongoing measurement, the current mode can be started. This stops the measurement automatically.

3.2.2.3. Mode.Select KFT
Mode.KFTQuantity Ipol, Upol

Selection of the standard mode. Mode and the measured quantity belong to the complete selection.

If a method is selected from the method memory, the nodes &Mode.Select and &Mode.XXXQuantity are overwritten with mode and measured quantity of the corresponding user method.

3.2.2.4. Mode.Name read only
 Name of the current method in the working memory. \$Q sends 8 ASCII characters. Standard methods carry the name *****. The node can be set read + write, see 3.2.2.62.

3.2.2.5. Mode.Def.Formulas.1.Formula EPX, CXX, RSX, +, -, *, /, (,)
Mode.Def.Formulas.1.TextRS up to 8 ASCII characters
Mode.Def.Formulas.1.Decimal 0...2...5
Mode.Def.Formulas.1.Unit up to 6 ASCII characters
Mode.Def.Formulas.1.Limits ON, OFF
Mode.Def.Formulas.1.LoLim 0...±999 999
Mode.Def.Formulas.1.UpLim 0...±999 999
Mode.Def.Formulas.1.Output active, pulse, OFF
Mode.Def.Formulas.2.Formula
 etc. up to .9

Entry of formulas. Rules for formula entry, see page 25.

Example: "(EP2-EP1)*C01/C00"

In addition to the formula, a text for result output, the number of decimal places and a unit for the result output can be selected. "No unit" is selected with the blank string.

In place of "RSX", a result name may be entered (.TextRS). This name is outputted in the report full, short, scalc full and scalc srt. It is used for the result and the corresponding mean value.

The limit control for results can also be activated. If a result is out of limit, a message appears in the result report, E196 is sent, and output line L13 can be set.

3.2.2.6. Mode.Def.SiloCalc.Assign.C24 RSX, EPX, CXX
Mode.Def.SiloCalc.Assign.C25 RSX, EPX, CXX
Mode.Def.SiloCalc.MatchId id1, id1&2, all, **OFF**
 .Assign.C2X: Assignment to store results in the silo as C2X.
 .MatchId: Indication which sample identification(s) have to match so that the results can be combined.

3.2.2.7. Mode.Def.ComVar.C30 RSX, MNX, EPX, CXX
Mode.Def.ComVar.C31
 etc., up to **.C39**
 Assignment of common variables.
 The values of the common variables are to be found in &Config.ComVar. They can be viewed and entered there, see 3.2.2.50.

3.2.2.8. Mode.Def.Report.Assign1
Mode.Def.Report.Assign2
 param, full, short, mplist, curve, scalc full, scalc srt, calc, ff
 Definition of the report sequence, which is outputted automatically at the end of the determination. Entries of more than one block have to be separated with ";".
 .Assign1: Output to COM1 of the Titrino. Identical for COM2.

3.2.2.9. Mode.Def.Mean.1.Assign **RS1**, RSX, EPX, CXX
Mode.Def.Mean.2.Assign
 etc., up to **.9**
 Assignment of the statistics calculations. Valid assignments are a requirement for statistics calculations. In addition, the statistics calculation must be switched on, see 3.2.2.24. Rules for statistics calculations see page 29.

3.2.2.10. Mode.CFmla
Mode.CFmla.1.Value **0...±999999**
Mode.CFmla.2.Value
 etc., up to **.19**

Calculation constants specific to a method. Stored in the method memory of the Titrino. Operands specific to the sample (3.2.2.52 and 3.2.2.63) and values of common variables (3.2.2.50) on the other hand are not stored with the methods.

3.2.2.16.	Mode.Parameter.TitrPara.StartV.Type	abs., rel., OFF
	Mode.Parameter.TitrPara.StartV.V	0...999.99
	Mode.Parameter.TitrPara.StartV.Factor	0...±999999
	Mode.Parameter.TitrPara.StartV.Rate	0.01...150, max.

Start volume.

If an absolute start volume (abs.) has been selected, the volume in mL is valid.

A relative start volume (rel.) is dispensed as a function of the sample size:

Start volume in mL = smpl size * factor

The factor is valid.

The dispensing rate in mL/min applies to both cases. Max. means maximum possible dispensing rate with the Exchange Unit in current use.

3.2.2.17.	Mode.Parameter.TitrPara.Pause	0...999999
------------------	--------------------------------------	-------------------

Pause time in s. Is waited off after the dispensing of the start volume.

3.2.2.18.	Mode.Parameter.TitrPara.ExtrT	0...999999
------------------	--------------------------------------	-------------------

Extraction time in s.

3.2.2.19.	Mode.Parameter.TitrPara.Ipol	-127... 50 ...+127
	Mode.Parameter.TitrPara.Upol	-1270... 400 ...+1270
	Mode.Parameter.TitrPara.PolElectrTest	ON, OFF

With Ipol, the inquiries for the polarization current in μA (Ipol) and .PolElectrTest are valid.

With Upol, the inquiry for the polarization voltage in mV (Upol) is valid. Entry in steps of 10 mV.

Besides .PolElectrTest is valid.

If the test for polarized electrodes is switched on, it is performed on change-over from the inactive state to an active state (titration or conditioning).

3.2.2.20.	Mode.Parameter.TitrPara.Temp	-170.0... 25.0 ...500.0
------------------	-------------------------------------	--------------------------------

Titration temperature in $^{\circ}\text{C}$.

3.2.2.21.	Mode.Parameter.TitrPara.TDelta	1... 2 ...999999
------------------	---------------------------------------	-------------------------

Time interval in s for the entry of a measurement point in the list of measured points.

3.2.2.22. Mode.Parameter.StopCond.VStop.Type **abs.**, rel., OFF
Mode.Parameter.StopCond.VStop.V 0...**99.99**...9999.99
Mode.Parameter.StopCond.VStop.Factor 0...±**999999**

Stop volume.

If an absolute stop volume (abs.) has been selected, the volume in mL is valid.

A relative stop volume (rel.) is dispensed as a function of the sample size:

Stop volume in mL = $\text{smpI size} * \text{factor}$

The factor is valid.

OFF means that the criterion is not monitored.

3.2.2.23. Mode.Parameter.StopCond.FillRate 0.01...150, **max.**
 Filling rate in the titration in mL/min. Max. means maximum possible filling rate with the Exchange Unit in current use.

3.2.2.24. Mode.Parameter.Statistics.Status ON, **OFF**
Mode.Parameter.Statistics.MeanN **2**...20
Mode.Parameter.Statistics.ResTab.Selected **original**, delete n, delete all
Mode.Parameter.Statistics.ResTab.DeIN **1**...20

Entries for the statistics calculations.

.Status: On/off switching. Requirement for statistics calculations is a valid assignment, see 3.2.2.9.

.MeanN: Number of individual results for statistics calculations.

.ResTab.Select: Selection of the table for the statistics calculations.

original: Original table. The original table is (again) set up, i.e. any individual results which have been deleted are reincorporated in the statistics calculations.

delete n: Single result lines are removed from the statistics calculation. All results of the corresponding line in the statistics table are deleted. Specification of the line number in .ResTab.DeIN.

delete all: Clear entire statistics table. The results can not be reactivated.

.ResTab.DeIN: Specification of the line number to be deleted.

3.2.2.25. Mode.Parameter.Presel.Cond **ON**, OFF
Mode.Parameter.Presel.DriftDisp **ON**, OFF
Mode.Parameter.Presel.DCor.Type auto, man., **OFF**
Mode.Parameter.Presel.DCor.Value **0.0**...99.9

.Cond: Conditioning ON/OFF

.DriftDisp: Drift display during conditioning ON/OFF.

.DCor.Type: Type of drift take-over for the drift correction. auto: Take-over of the drift value at start.

.DCor.Value: Drift value for the manual drift correction.

3.2.2.26. Mode.Parameter.Presel.IReq id1, id1&2, all, **OFF**
Mode.Parameter.Presel.SReq value, unit, all, **OFF**

Automatic inquiry after the start of the determination. From such an inquiry, the determination continues if the requested entry/entries is/are made, e.g. &SmpIData.OFFSilo.Id1 (see 3.2.2.52) or with &M \$G, see 3.2.2.1. \$H is not possible in requests.

3.2.2.27. Mode.Parameter.Presel.LimSmpISize.Status ON, **OFF**
Mode.Parameter.Presel.LimSmpISize.LoLim 0.0...999 999
Mode.Parameter.Presel.LimSmpISize.UpLim 0.0...**999 999**

Limit control for the sample size.

3.2.2.28. Mode.Parameter.Presel.Oven COM1, COM2, **no**

If an oven is connected, its result will be incorporated into the result report of the Titrino. If there is no oven connected via RS232, the setting of this parameter has to be "no".

3.2.2.29. Mode.Parameter.Presel.ActPuls first, all, cond., **OFF**
Output of a pulse on the I/O line "Activate", see page 126.

3.2.2.30. UserMeth.FreeMem read only
Memory space, available for user methods or silo lines. \$Q sends the number of free bytes, e.g. "4928".

3.2.2.31. UserMeth.Recall \$G
UserMeth.Recall.Name up to 8 ASCII characters
UserMeth.Store \$G
UserMeth.Store.Name up to 8 ASCII characters
UserMeth.Delete \$G
UserMeth.Delete.Name up to 8 ASCII characters
UserMeth.DeIAll \$G

Management of the internal method memory: Load, store and delete methods. An action is performed if "\$G" is sent to the corresponding node just after entering the name.

Do not use blank characters before and after method name!

.DeIAll: Deletes all methods in the user memory.

3.2.2.32.	UserMeth.List.1.Name	read only
	UserMeth.List.1.Mode	read only
	UserMeth.List.1.Quantity	read only
	UserMeth.List.1.DosUnit	read only
	UserMeth.List.1.Bytes	read only
	UserMeth.List.1.Checksum	read only
	for each method	

List of the methods in the user method memory with the following characteristics:

.Name:	Name of the method
.Mode:	Mode
.Quantity:	Measured quantity
.DosUnit:	Buret of the method
.Bytes:	Number of bytes of the user memory used by the method
.Checksum:	Checksum of the method, see 3.2.2.61.

3.2.2.33.	Config.Monitoring.Validation.Status	ON, OFF
	Config.Monitoring.Validation.Interval	1...365...9999
	Config.Monitoring.Validation.Counter	0...9999
	Config.Monitoring.Validation.ClearCount	\$G

Monitoring of validation.

.Interval:	Time interval in days for validation.
.Counter:	Time counter in days since last validation.
.ClearCount:	Clears the above counter.

3.2.2.34.	Config.Monitoring.Service.Status	ON, OFF
	Config.Monitoring.Service.Date	YYYY-MM-DD

Monitoring of service interval.

3.2.2.35.	Config.Monitoring.DiagRep	ON, OFF
------------------	----------------------------------	---------

Printing of system test report after each switching on of the Titrimo.

3.2.2.36.	Config.PeriphUnit.CharSet1	Epson, Seiko, Citizen, HP, IBM
	Config.PeriphUnit.CharSet2	

Selection of the character set and the graphics control characters for COM1 resp. COM2 of the Titrimo.

IBM means the IBM character set following character set table 437 and IBM graphics control characters. Select 'IBM' for work with the computer.

3.2.2.37.	Config.PeriphUnit.RepToComport	1, 2, 1&2
------------------	---------------------------------------	-----------

Selection of COM of the Titrimo where manually triggered reports should be outputted.

3.2.2.38.	Config.PeriphUnit.Balance	Sartorius, Mettler, Mettler AT, AND, Precisa
------------------	----------------------------------	--

Selection of the balance type.

3.2.2.39. Config.PeriphUnit.Stirrer ON, **OFF**
Automatic stirrer control. With "ON" the stirrer will be switched on after starting a method. At the end of the method it is switched off again.

3.2.2.40. Config.PeriphUnit.RemoteBox.Status ON, **OFF**
Config.PeriphUnit.RemoteBox.Keyboard **US**, deutsch, francais, español, schweiz.
Config.PeriphUnit.RemoteBox.Barcode **input**, method, id1, id2, id3, smpl size

Connections via Remote Box.

.Status: Select if a Remote Box is connected.

.Keyboard: Type of keyboard which is connected to the Remote Box.

.Barcode: Select target in Titrimo where you wish to have the string from the barcode reader. "input" means that the string comes into the field where the cursor is currently placed.

3.2.2.41. Config.Aux.Language **english**, deutsch, francais, español, italiano, portugese, svenska
Selection of the dialog language.

3.2.2.42. Config.Aux.Set \$G
Config.Aux.Set.Date YYYY-MM-DD
Config.Aux.Set.Time hh:mm

Date and time.

Input format of the date: Year-month-day, two-digit, enter leading zeros.

Input format for the time: Hours:minutes, two-digit, enter leading zeros.

Date and time have to be set with &Config.Aux.Set \$G just after entry of the value.

3.2.2.43. Config.Aux.RunNo 0...9999
Current sample number.
Set to 0 on power on and initialization. After 9999, counting starts again at 0.

3.2.2.44. Config.Aux.AutoStart 1...9999, **OFF**
Number of automatic, internal starts.

3.2.2.45. Config.Aux.StartDelay 0...999999
Start delay time in s. During this time, the data of the preceding determination are retained.

3.2.2.46. Config.Aux.ResDisplay **bold**, standard
Character set for the result display at the end of the determination.

3.2.2.47. Config.Aux.DevName up to 8 ASCII characters
 Name of the instrument for connections with several units. It is advisable to use only the letters A...Z (ASCII No. 65...90), a...z (ASCII No. 97...122) and the numbers 0...9 (ASCII No. 48...57) when the function Setup.AutoInfo (3.2.2.92) is used at the same time.
 If a name has been entered, it will be printed out in the result report (full, short).

3.2.2.48. Config.Aux.Prog read only
 Output of the program version.
 The Titrimo sends "795.0010" on requests with \$Q.

3.2.2.49. Config.RSSet1 \$G
Config.RSSet1.Baud 300, 600, 1200, 2400, 4800, **9600**, 19200, 38400, 57600, 115200
Config.RSSet1.DataBit 7, **8**
Config.RSSet1.StopBit 1, 2
Config.RSSet1.Parity even, odd, **none**
Config.RSSet1.Handsh **HWs**, SWchar, SWline, none

\$G sets all RS settings. The changes are performed only if the instrument is inactive. After the setting of the interface parameters, wait at least 2 s to allow the components to equilibrate.

Settings of the values for the data transmission via the RS interface: baud rate, data bit, stop bit, parity and type of handshake, see also page 90ff. Baud rates >9600 need a PC which is equipped accordingly (e.g. with 16550 component).

The setting of the values must be initiated with \$G immediately after entry of the values.

3.2.2.50. Config.ComVar.C30 0... ±999999
 with up to **.C39**, etc.
 Values of the common variables from C30 up to C39. Insert the common variables directly or describe the determination results directly from the method, see 3.2.2.7.

3.2.2.51. SmpData.Status ON, OFF
 On/off switching of silo memory. When the silo memory is switched on, the sample data are fetched from the lowest valid silo line.

3.2.2.52.	SmplData.OFFSilo.Id1	up to 8 ASCII characters
	SmplData.OFFSilo.Id2	up to 8 ASCII characters
	SmplData.OFFSilo.Id3	up to 8 ASCII characters
	SmplData.OFFSilo.ValSmpl	6-digits, sign and decimal point
	SmplData.OFFSilo.UnitSmpl	up to 5 ASCII characters

Current sample data.

The identifications Id1...Id3 can be used in formulas as sample-specific calculation constants C21...C23.

If "no unit" is desired for the unit of the sample size, the blank string must be entered.

3.2.2.53.	SmplData.ONSil.Counter.MaxLines	read only
	SmplData.ONSil.Counter.FirstLine	read only
	SmplData.ONSil.Counter.LastLine	read only

Information on silo memory.

.MaxLines: Maximum possible number of silo lines.

.FirstLine: Lowest valid silo line.

.LastLine: Last occupied silo line.

3.2.2.54.	SmplData.ONSil.EditLine.1.Method	up to 8 ASCII characters
	SmplData.ONSil.EditLine.1.Id1	up to 8 ASCII characters
	SmplData.ONSil.EditLine.1.Id2	up to 8 ASCII characters
	SmplData.ONSil.EditLine.1.Id3	up to 8 ASCII characters
	SmplData.ONSil.EditLine.1.ValSmpl	6-digits, sign and dec.point
	SmplData.ONSil.EditLine.1.UnitSmpl	up to 5 ASCII characters
	SmplData.ONSil.EditLine.1.C24	read only
	SmplData.ONSil.EditLine.1.C25	read only
	SmplData.ONSil.EditLine.1.Mark	read only
	etc., up to .255	

Contents of a silo line.

.Method: Method used to process the sample, from the method memory or from the card.

.Id: The identifications Id1...Id3 can also be used as sample-specific calculation constants C21...C23 in formulas.

.UnitSmpl: If "no unit" is desired for the sample size, the blank string must be entered.

.C24, .C25: Results which have been assigned to C24 and C25.

.Mark: Mark of the silo line: "*" = deleted line, "+" = line which is worked off, "-" = line which is worked off and not valid for silo calculations (deleted), "/" = last worked-off line, where recalculation can still be done. Silo lines which have been worked off are "read only".

3.2.2.55.	SmplData.ONSil.DelLine	\$G
	SmplData.ONSil.DelLine.LineNum	1...255, OFF

Deletion of a silo line. The line # is deleted with &SmplData.ONSil.DelLine

\$G. If a formerly deleted line is edited again, it becomes valid (function "undelete").

3.2.2.56. SmpIData.ONSilO.DeIAll \$G
 Deletes the entire silo memory. Must be triggered with \$G.

3.2.2.57. SmpIData.ONSilO.CycleLines ON, OFF
 Silo data cycling.
 With "ON", executed lines are copied to the next free silo lines, see page 40.
 Exercise caution if you edit the silo memory during the determinations!

3.2.2.58. SmpIData.ONSilO.SaveLines ON, OFF
 Silo lines are not deleted when they are worked off. Assigned results are stored as C24 and C25. "Save lines" can only be set to "ON" if the silo is completely empty. Delete the silo, see 3.2.2.56.

3.2.2.59. HotKey.User.Name up to 10 ASCII characters
HotKey.User.Delete \$G
HotKey.User.Delete.Name up to 10 ASCII characters
HotKey.User.DeIAll \$G
HotKey.User.List.1.Name read only
 Management of user names.
 .Name: Input of user names.
 .Delete.Name: Deletes selected user name with &HotKey.User.Delete \$G.
 .List: List of all user names.

3.2.2.60. Info.Report \$G
Info.Report.Select configuration, parameters, smpl data, statistics, silo, C-fmla, def, user method, full, short, mplist, curve, scalc full, scalc srt, calc, all, ff
 \$G sends the selected report to the COM which is set in &Config.PeriphUnit.RepToComport:
 configuration: Configuration report. Is not accessible during a running determination.
 parameters: Parameter report of the current method. During a running determination only "live"-parameters are accessible.
 smpl data: Current sample data.
 statistics: Statistics table with the individual results.
 silo: Contents of the silo memory.
 C-fmla: Contents of the <C-fmla> key.
 def: Contents of the <def> key.
 user method: Contents of the method memory.
 full: Full result report of the last completed determination.
 short: Short result report of the last completed determination.
 mplist: Measuring point list of the running determination.
 curve: Curve volume vs. time of the last determination.
 scalc full: Full report of the silo calculations.
 scalc srt: Short report of the silo calculations.
 calc: Calculation report of the current method.
 all: All reports.
 ff: Form feed on printer.

Reports which are sent from the Titrino are marked with space (ASCII 32) and ' at the beginning. Then an individual identifier for each report follows. Reports which are triggered by RS232 (\$G) have the same introducer but without preceding space, i.e. they start with '.

3.2.2.61. Info.Checksums \$G
Info.Checksums.MPList read only
Info.Checksums.ActualMethod read only

The checksums can be used to identify the content of a file unequivocally, e.g. files with identical content have identical results of the checksums. An empty file has checksum "0". The calculation of the checksums is triggered with \$G.

.MPList: Result of the checksum of the current measuring point list.

.ActualMethod: Result of the checksum of the current method in the working memory. Identical methods with different method names have the same results of the checksum.

3.2.2.62. Info.DetermData \$G
Info.DetermData.Write ON, OFF
Info.DetermData.MPList.1.Attribute read only/read+write
Info.DetermData.ExV read only/read+write
Info.DetermData.MPList.1.X read only/read+write
Info.DetermData.MPList.1.Y read only/read+write
Info.DetermData.MPList.1.Z1 read only/read+write
Info.DetermData.MPList.1.Z2 read only/read+write
for every measuring point

Determination data in hexadecimal format. A measuring point list is available. Recalculation of the measuring data is triggered with \$G.

.Write: With "ON", the following nodes can be overwritten:
&Info.DetermData.MP.List, &Info.TitrResults.Var.C4X (X = 0..5),
and &Mode.Name.

.ExV: Volume of the exchange unit, with which the determination was executed

.MPList.1.Attribute: Attribute

.MPList.X: X coordinate, time

.MPList.Y: Y coordinate, volume

.MPList.Z1: Z1 coordinate, measuring value

.MPList.Z2: without meaning

3.2.2.63.	Info.TitrResults.RS.1.Value	read only
	etc., up to .9	
	Info.TitrResults.EP.1.V	read only
	Info.TitrResults.EP.1.Meas	read only
	etc., up to .2	
	Info.TitrResults.Var.C40	read only/read + write
	etc., up to .C45	
	Info.TitrResults.Var.DTime	read only/read + write

.RS: Values of the calculated results.

.EP: Endpoints:

Volume coordinate in mL, e.g. "1.2340"

Measured value coordinate in mV (with lpol) "-241" or μA (with Upol) "43.7".

.Var: Various variables. You may overwrite the variables C40...C45, see 3.2.2.62.

C40: Initial measured value in mV (with lpol) "41" or μA (with Upol).

C41: End volume in mL, "12.5360".

C42: Time from start of titration to end in s, "62".

C43: Volume drift on start of KFT titration from the conditioning in $\mu\text{L}/\text{min}$, "3.5".

C44: Temperature in $^{\circ}\text{C}$.

C45: Start volume in mL, "2.800".

DTime: Time for the drift correction in KFT with conditioning.

3.2.2.64.	Info.StatisticsVal.ActN	read only
	Info.Statistics.1.Mean	read only
	Info.Statistics.1.Std	read only
	Info.Statistics.1.RelStd	read only
	etc. up to .9	

The current values of the statistics calculation.

\$Q sends, e.g.

ActN: Current value of the individual results "3"

Data for MN1:

Mean: Mean value (decimal places as in result) "3.421"

Std: Standard deviation (1 decimal place more than in result) "0.0231"

RelStd: Relative standard deviation (in %, 2 decimal places) "0.14"

3.2.2.65.	Info.SiloCalc.C24.Name	read only
	Info.SiloCalc.C24.Value	read only
	Info.SiloCalc.C24.Unit	read only
	for .C25 as for .C24	
	Info.SiloCalc.C26.ActN	read only
	Info.SiloCalc.C26.Mean	read only
	Info.SiloCalc.C26.Std	read only
	Info.SiloCalc.C26.RelStd	read only
	for .C27 as for .C26	

The current values from the silo calculations. C26 is the mean value out of the C24 variables; C27 comes from C25.

\$Q sends:

C24.Name: Name of the assigned value	"RS1"
C24.Value: Value	"2.222"
C24.Unit: Unit of the assigned value	"%"
C26.ActN: Number of single results	"3"
C26.Mean: Mean (decimal places as for the result itself)	"3.421"
C26.Std: Standard deviation (decimal places as for the result + 1)	"0.0231"
C26.RelStd: Relative standard deviation (in %, 2 decimal places)	"0.14"

3.2.2.66. Info.ActualInfo.Inputs.Status read only
Info.ActualInfo.Inputs.Change read only
Info.ActualInfo.Inputs.Clear \$G
Info.ActualInfo.Outputs.Status read only
Info.ActualInfo.Outputs.Change read only
Info.ActualInfo.Outputs.Clear \$G

Status sends the current status of the I/O lines, Change sends the information regarding whether a change in status of a line has taken place since the last clearing, Clear clears the change information. For the output, there is a conversion from binary to decimal, e.g.

		0		0		0		0		0		0		0		0		1		0		1		0					
Line No.		13		12		11		10		9		8		7		6		5		4		3		2		1		0	

Output: $2^1 + 2^3 = "10"$

1 means ON or change; 0 means OFF or no change.

The lines are assigned as follows (see also page 125ff):

Inputs:		Outputs:	
0	Start (pin 21)	0	Ready (pin 5)
1	Stop (pin 9)	1	Cond. ok (pin 18)
2	Enter (pin 22)	2	Titration (pin 4)
3	Clear (pin 10)	3	EOD (pin 17)
4	Smpl Ready (pin 23)	4	Monitoring, line L4 (pin 3)
5	pin 11	5	Error (pin 16)
6	pin 24	6	Activate, line L6 (pin 1)
7	pin 12	7	Pulse for recorder (pin 2)
		8	not used (pin 6)
		9	not used (pin 7)
		10	not used (pin 8)
		11	not used (pin 13)
		12	not used (pin 19)
		13	not used (pin 20)

3.2.2.67. Info.ActualInfo.Assembly.CyclNo read only

\$Q sends the current cycle number of the voltage measurement cycle, e.g. "127". From the cycle number and the cycle time (see 3.2.2.75), a time frame can be set up.

The cycle number is set to 0 on switching on the instrument, on every start and for QuickMeas. It is incremented as long as the instrument remains switched on.

3.2.2.68. **Info.ActualInfo.Assembly.Counter.V** read only
Info.ActualInfo.Assembly.Counter.Clear \$G
 \$Q sends the volume. With the function &Info.Assembly.Counter.Clear \$G, the volume counter is set to zero.

3.2.2.69. **Info.ActualInfo.Assembly.Meas** read only
 \$Q sends the current measured value from the assembly.

3.2.2.70. **Info.ActualInfo.Titrator.CyclNo** read only
Info.ActualInfo.Titrator.V read only
Info.ActualInfo.Titrator.Meas read only
Info.ActualInfo.Titrator.dVdt read only
Info.ActualInfo.Titrator.dMeasdt read only
Info.ActualInfo.Titrator.dMeasdV read only
Info.ActualInfo.Titrator.T read only

\$Q sends the current values in the following formats:

	KFT
CyclNo	127
V(mL)	1.2345
Meas:	
I _{pol} (mV)	-345.6
U _{pol} (μA)	-12.5
dVdt (μL/s)	2.5142
dMeasdt	
I _{pol} (mV/s)	0.7957
U _{pol} (μA/s)	0.7957
dMeasdV (mV/μL)	10.6326

NV: Not Valid.

OV will be sent for "overrange".

A time frame can be set up from the cycle number and the cycle time (see 3.2.2.75). The cycle number is set to 0 at the start of a method and it is incremented until the end of the method.

3.2.2.71. **Info.ActualInfo.MeasPt.Index** read only
Info.ActualInfo.MeasPt.X read only
Info.ActualInfo.MeasPt.Y read only
Info.ActualInfo.MeasPt.Z1 read only
Info.ActualInfo.MeasPt.Z2 read only
Info.ActualInfo.EP.Index read only
Info.ActualInfo.EP.X read only
Info.ActualInfo.EP.Y read only

\$Q sends the last entry into the measuring point list (.MeasPt) or the last entry into the list of EP's.

.MeasPt.X"165" Time of the MPList in s
 .MeasPt.Y"3.654" Volume of the MPList in mL
 .MeasPt.Z1"6.34" Measured value of the MPList, format depends on the measured quantity
 .MeasPt.Z2 without meaning
 .EP.X"1.234" Volume coordinate of the EP
 .EP.Y"5.34" Measured value coordinate of the EP

3.2.2.72. **Info.ActualInfo.Oven.HeatTime** read only
Info.ActualInfo.Oven.SampleTemp read only
Info.ActualInfo.Oven.LowTemp read only
Info.ActualInfo.Oven.HighTemp read only
Info.ActualInfo.Oven.GasFlow read only
Info.ActualInfo.Oven.UnitFlow read only

\$Q sends the current values from a connected KF Oven. If no Oven is connected, the values are empty.

.HeatTime: Heating time of sample in s.
 .SampleTemp: Nominal sample temperature in °C.
 .LowTemp: Lowest temperature during the sample heating time in °C.
 .HighTemp: Highest temperature during the sample heating time in °C.
 .GasFlow: Average gas flow during sample heating time.
 .UnitFlow: Unit of gas flow.

3.2.2.73. **Info.ActualInfo.Display.L1** up to 32 ASCII characters
Info.ActualInfo.Display.L8 up to 32 ASCII characters
Info.ActualInfo.Display.DelAll \$G

Lines of the display. The display can be written to from the computer. Proceed as follows:

1. Lock the display, see 3.2.2.86.
2. Delete the whole display (.DelAll).
3. For writing onto the display, the standard character set will be used.
4. Unlock the display, see 3.2.2.86.
5. Delete the whole display (.DelAll).
6. Send a value to nod &Config.Aux.ResDisplay (see 3.2.2.46) to refresh the display.

\$Q sends the contents of the corresponding display line.

3.2.2.74. **Info.ActualInfo.Comport.Number** read only
 \$Q sends the comport number of the Titrino where the PC is connected.

3.2.2.75. **Info.Assembly.CycleTime** read only
Info.Assembly.ExV read only

Inquiries regarding basic variables of the assembly: Cycle time in s, volume of the active Exchange Unit in mL.

3.2.2.76.	Assembly.Bur.Rates.Forward.Selected	digital, analog
	Assembly.Bur.Rates.Forward.Digital	0...150, max.
	Assembly.Bur.Rates.Reverse.Selected	digital, analog
	Assembly.Bur.Rates.Reverse.Digital	0...150, max.

Expel and aspirating rate.

Digital or analog control. With digital control, the inputted value applies (in mL/min). "max." means maximum possible rate with the Exchange Unit in current use.

Analog means rate control with the analog potentiometer on Titrino.

3.2.2.77.	Assembly.Bur.Fill	\$G, \$H, \$C
------------------	--------------------------	---------------

\$G starts the 'FILL' mode of the buret function.

3.2.2.78.	Assembly.Bur.ModeDis	\$G, \$S, \$H, \$C
	Assembly.Bur.ModeDis.Selected	volume , time
	Assembly.Bur.ModeDis.V	0.0001... 0.1 ...9999
	Assembly.Bur.ModeDis.Time	0.25... 1 ...86400
	Assembly.Bur.ModeDis.VStop	0.0001...9999, OFF
	Assembly.Bur.ModeDis.AutoFill	ON, OFF

Dispensing mode with parameters. The dispensing mode can only be started and stopped via the RS Control. During a running dosification, no method can be started at the Titrino.

.Selected: Dispensing of volume increments or during a preset time.

.Volume, .Time: Size of the volume increments or entry of time.

.VStop: Limit volume for the dispensing.

.AutoFill: ON means automatic filling after every dispensing.

3.2.2.79.	Assembly.Meas.Status	ON, OFF
	Assembly.Meas.MeasInput	Ip _{ol} , Up _{ol}
	Assembly.Meas.Ip_{ol}	±127... 1 ...+127
	Assembly.Meas.Up_{ol}	±1270... 400 ...+1270

Measurement in assembly. The measuring function can only be started via RS Control. When the measuring function is switched on, no method can be started at the Titrino.

.Input: Selection of the "measuring input" for polarized electrodes.

.Ip_{ol}: Polarization current in µA.

.Up_{ol}: Polarization potential in mV, entry in steps of 10 mV.

3.2.2.80. Assembly.Outputs.AutoEOD **ON, OFF**
Assembly.Outputs.SetLines **\$G**
Assembly.Outputs.SetLines.L0 active, inactive, pulse, **OFF**
 up to .L13
Assembly.Outputs.ResetLines **\$G**

Setting the I/O output lines.

.AutoEOD: The automatic output of the EOD (End of Determination) at the end of the determination can be switched off. Thus, for example, in conjunction with a Titrino several determinations can be performed in the same beaker. Before AutoEOD is switched on, line 3 must be set to "OFF".

.SetLines: With \$G, all lines are set.

.SetLines.LX: Set the line LX. "active" means setting of a static signal, "inactive" means resetting of the signal, "pulse" means output of a pulse of app. 150 ms, "OFF" means the line is not operated, see also page 126.

Warnings:

- If you have "AutoEOD" to "ON", an active line 3 is set to "inactive" by the EOD pulse.
- L6 is the line of the activate pulse. An active line 6 is set to "inactive" by the activate pulse.
- L5 is the error line. It is continuously controlled by the Titrino program and can therefore not be set freely.

Line assignments in Titrino program:

L0	Ready, inactive state
L1	Conditioning OK
L2	Titration in progress
L3	EOD (End Of Determination)
L4	---
L5	Error
L6	Activate pulse
L7	Buret volume pulses
L8-13	---

.ResetLines: Lines are set to the inactive status (= high).

3.2.2.81. Assembly.Stirrer **ON, OFF**
 Switching stirrer ON/OFF.

3.2.2.82. Setup.Comport **1, 2, 1&2**
 Selects the Titrino COM for the output of automatic info:
 &Setup.Keycode
 &Setup.Trace
 &Setup.SendMeas
 &Setup.AutoInfo

3.2.2.83. Setup.Keycode ON, OFF

ON means the key code of a key pressed on the Titrino is outputted. The key code comprises 2 ASCII characters; table of the keys with their code, see page 102. A keystroke of key 11 is sent as follows:

#11

The beginning of the message is marked by a space (ASCII 32).

3.2.2.84. Setup.Tree.Short ON, OFF
Setup.Tree.ChangedOnly ON, OFF

Definition of the type of answer to \$Q.

.Short: With "ON", each path is sent with only the necessary amount of characters in order to be unequivocal (printed in bold in this manual). A combination of .Short and .ChangedOnly is not possible.

.ChangedOnly: Sends only the changed values, i.e. values which have been edited. All paths are sent absolute, i.e. from the root.

3.2.2.85. Setup.Trace ON, OFF

The Titrino automatically reports when a value has been confirmed with <enter> at the Titrino. Message, e.g.:

&SmplData.OFFSilo.Id1"Trace"

The beginning of the message is marked by a space (ASCII 32).

3.2.2.86. Setup.Lock.Keyboard ON, OFF
Setup.Lock.Config ON, OFF
Setup.Lock.Parameter ON, OFF
Setup.Lock.SmplData ON, OFF
Setup.Lock.UserMeth.Recall ON, OFF
Setup.Lock.UserMeth.Store ON, OFF
Setup.Lock.UserMeth.Delete ON, OFF
Setup.Lock.Display ON, OFF

ON means disable the corresponding function:

.Keyboard: Disable all keys of the Titrinos

.Config: Disable the <configuration> key

.Parameter: Disable the <parameter> key

.SmplData: Disable the <smpl data> key

.UserMeth.Recall: Disable "recall" in <user meth> key

.UserMeth.Store: Disable "store" in <user meth> key

.UserMeth.Delete: Disable "delete" in <user meth> key

.Display: Disable the display, i.e. it will not be written to by the device program of the Titrino and can be operated from the computer.

3.2.2.87. Setup.Mode.StartWait ON, OFF
Setup.Mode.FinWait ON, OFF

Holding points in the method sequence. If they are "ON", the sequence stops until "OFF" is sent. Switching the instrument on sets both nodes to OFF:

.StartWait: Holding point right after starting a method (holding point after AutoInfo !" .T.GC").

.FinWait: Holding point at the end a method (holding point after AutoInfo !" .T.F").

3.2.2.88. Setup.SendMeas.SendStatus ON, OFF
Setup.SendMeas.Interval 0.08...4...16200, MPList

.SendStatus: ON means the automatic transmission of measured values (see 3.2.2.90 and 3.2.2.91) in the inputted interval is active.

.Interval: Time interval (in s) for the automatic transmission of associated measured values defined under points 3.2.2.90 and 3.2.2.91. The inputted value is rounded off to a multiple of 0.08. The smallest possible time interval depends on the number of measured values which have to be sent, on the baud rate, on the load on the interface and on the type of device connection. With "MPList" the measured values are sent at the time of their entry into the measured point list.

The automatic transmission is switched on/off with 'SendStatus'.

3.2.2.89. Setup.SendMeas.Select Assembly, Titrator
 Selection of the unit of which the measured values should be sent (3.2.2.90 and 3.2.2.91).

3.2.2.90. Setup.SendMeas.Assembly.CyclNo ON, OFF
Setup.SendMeas.Assembly.V ON, OFF
Setup.SendMeas.Assembly.Meas ON, OFF

Selection of the values from Assembly for the output in the set time interval (see 3.2.2.88):

.CyclNo: Cycle number of the potential measurement. Together with the cycle time (3.2.2.75), a time frame can be set up. The cycle number is set to 0 on switching on the instrument and it is always incremented as long as the instrument remains switched on.

.V: Volume

.Meas: Measured value associated to the cycle number.

The unit "assembly" must be preset (see 3.2.2.89).

3.2.2.91. Setup.SendMeas.Titrator.CyclNo ON, OFF
Setup.SendMeas.Titrator.V ON, OFF
Setup.SendMeas.Titrator.Meas ON, OFF
Setup.SendMeas.Titrator.dVdt ON, OFF
Setup.SendMeas.Titrator.dMeasdt ON, OFF
Setup.SendMeas.Titrator.dMeasdV ON, OFF

Selection of the values from the titrator which are sent in the set time interval (see 3.2.2.88, formats see 3.2.2.70):

.CyclNo: Cycle number. Together with the cycle time (see 3.2.2.75), a time frame can be set up. The other data belong to the corresponding cycle number. The cycle number is set to 0 at the start of a method and it is incremented until the end of the method.

.V: Volume.

.dVdt: associated volume drift.

.dMeasdt: associated measured value drift.

.dMeasdV: associated 1st derivative of the titration curve.
The unit "titrator" must be preset (see 3.2.2.90).

3.2.2.92.	Setup.AutoInfo.Status	ON, OFF
	Setup.AutoInfo.P	ON, OFF
	Setup.AutoInfo.T.R	ON, OFF
	Setup.AutoInfo.T.G	ON, OFF
	Setup.AutoInfo.T.GC	ON, OFF
	Setup.AutoInfo.T.S	ON, OFF
	Setup.AutoInfo.T.B	ON, OFF
	Setup.AutoInfo.T.F	ON, OFF
	Setup.AutoInfo.T.E	ON, OFF
	Setup.AutoInfo.T.H	ON, OFF
	Setup.AutoInfo.T.C	ON, OFF
	Setup.AutoInfo.T.O	ON, OFF
	Setup.AutoInfo.T.N	ON, OFF
	Setup.AutoInfo.T.Re	ON, OFF
	Setup.AutoInfo.T.Si	ON, OFF
	Setup.AutoInfo.T.M	ON, OFF
	Setup.AutoInfo.T.EP	ON, OFF
	Setup.AutoInfo.T.RC	ON, OFF
	Setup.AutoInfo.C.B1	ON, OFF
	Setup.AutoInfo.C.R1	ON, OFF
	Setup.AutoInfo.C.B2	ON, OFF
	Setup.AutoInfo.C.R2	ON, OFF
	Setup.AutoInfo.I	ON, OFF
	Setup.AutoInfo.O	ON, OFF

ON means that the Titrino reports automatically the moment the corresponding change occurs.

.Status: Global switch for all set AutoInfo.
.P PowerOn: Simulation of power on (3.2.2.94). Not from mains.

Messages from node .T, Titrator:

.T.R Ready: Status 'Ready' has been reached.
.T.G Go: Instrument has been started.
.T.GC GoCommand: Instrument has received a go command.
.T.S Stop: Status 'Stop' has been reached.
.T.B Begin of sequence.
.T.F Final: End of determination, the final steps will be carried out.
.T.E Error. Message together with error number, see page 49ff.
.T.H Hold: Status 'Hold' has been reached.
.T.C Continue: Continue after hold.
.T.O Conditioning OK: EP reached (in KFT with conditioning).
.T.N Conditioning Not OK: EP not reached (in KFT with conditioning).
.T.Re Request: In the inquiry of an identification or the sample size after start of titration.

.T.Si SiloEmpty: Silo empty, i.e. the last line has been removed from the silo memory.

.T.M MeasList: Entry in the measuring point list.

.T.EP EPList: Entry into EP list

.T.RC Results have been recalculated.

Messages from node .C, Comport:

.C.B1 COM1: A report is outputted on COM1. During this time, COM2 will be blocked. COM2 is generally blocked, if COM1 is busy.

.C.R1 COM1 is ready again. (Comes also when you <QUIT> an error.)

.C.B2, .R2 Identical for COM2.

Messages for changings in the I/O lines. If the changings are made simultaneously, there is 1 message. Pulses receive 2 messages: one message each for line active and inactive.

.I Input: Change of an input line.

.O Output: Change of an output line (except 7, pin 2, for recorder pulses).

If a change occurs that requires a message, the Titrimo sends space (ASCII 32) and ! as an introducer. This is followed by the name of the device (see 3.2.2.47). Special ASCII characters in the device name are ignored. If no device name has been entered, only ! is sent. Finally the Titrimo sends the information which node has triggered the message.

Example: !John".T.Si": The message was triggered from instrument "John", node .T.Si

3.2.2.93. Setup.Graphics.Grid	ON, OFF
Setup.Graphics.Frame	ON, OFF
Setup.Graphics.Scale	Full, Auto
Setup.Graphics.Recorder.Right	0.2... 0.5 ...1.00
Setup.Graphics.Recorder.Feed	0.01... 0.05 ...1.00

Change in the appearance and the format of the curve for the output. The settings are valid for both Titrimo COM ports.

.Grid: On/off switching of grid over curve.

.Frame: On/off switching of frame surrounding the curve. If grid and frame are switched off, the curve is printed faster as the print head does not have to move to the end of the paper.

.Scale: Type of scaling of the measured value axis: Full means that the scale runs from the smallest up to the greatest measured point. With auto, the smallest measured value is taken and the next smaller tick defines the beginning of the scale; the next greater tick to the greatest measured value is the end of the scale.

.Right: Relative specification of the width of the output medium (e.g. paper width) for the length of the measured value axis. 1 means the measured value axis is plotted over the entire width of the paper (largest possible width). In extreme cases, the writing of the right tick may lie outside.

.Feed: Length of the time axis. Depending on the printer, the measure in cm may not always be correct.

	Curve length
0.01	100 cm
0.1	10 cm
0.5	2 cm
1	1 cm

3.2.2.94. Setup.PowerOn \$G

Simulation of 'power on'. The device has the same status as after power on: The cylinder is filled, error messages deleted and the current sample number set to 0. The method last used is ready for operation.

3.2.2.95. Setup.Initialise \$G

Setup.Initialise.Select **ActMeth**, Silo, Config, Assembly, Setup, All

Setting of default values for the following areas:

ActMeth: Current method. Parameters, calculations, and assignments for the data output, operands C01...C19.

Silo: The silo memory is deleted. Same function as delete entire silo.

Config: All values under &Config.

Assembly: All values under &Assembly.

Setup: All values under &Setup.

All: Values of the entire tree (except silo and method memory).

The action must be triggered with &Setup.Initialise \$G.

3.2.2.96. Setup.Ramlnit \$G

Initializes instrument, see page 110. All parameters are set to their default value and error messages are cleared. The user and silo memories will be deleted. The user memory contains the default user methods from Metrohm.

3.2.2.97. Setup.InstrNo \$G

Setup.InstrNo.Value **serial number**, 8 ASCII characters

Instrument identification for report output.

Set the value with &Setup.InstrNo \$G .

3.2.2.98. Diagnose.Report \$G

Output of the report containing the adjustment parameters. The Titrimo has to be in its inactive basic state.

3.3 Properties of the RS 232 Interface

Data Transfer Protocol

The Titrino is configured as DTE (Data Terminal Equipment).

The RS 232 interface has the following technical specifications:

- Data interface according to the RS 232C standard, adjustable transfer parameters, see pages 11 and 75.
- Max. line length: 512 characters
- Control characters: C_R (ASCII DEC 13)
L_F (ASCII DEC 10)
XON (ASCII DEC 17)
XOFF (ASCII DEC 19)
- Cable length: max. approx. 15 m

Start	7 or 8 Data Bit	Parity Bit	1 or 2 Stop Bit
-------	-----------------	------------	-----------------

Only a shielded data cable (for example, METROHM D.104.0201) may be used to couple the Titrino with foreign devices. The cable shield must be properly grounded on both instruments (pay attention to current loops; always ground in a star-head formation). Only plugs with sufficient shielding may be used (for example, METROHM K.210.0381 with K.210.9045).

3.3.1 Handshake

Software-Handshake, SWchar

Handshake inputs on the Titrino (CTS) are not checked.
Handshake outputs (DTR, RTS) are set by the Titrino.
The Titrino sends XOFF when its input buffer contains 384 characters. After this it can receive 128 extra characters (including L_F).

Titirino as Receiver :

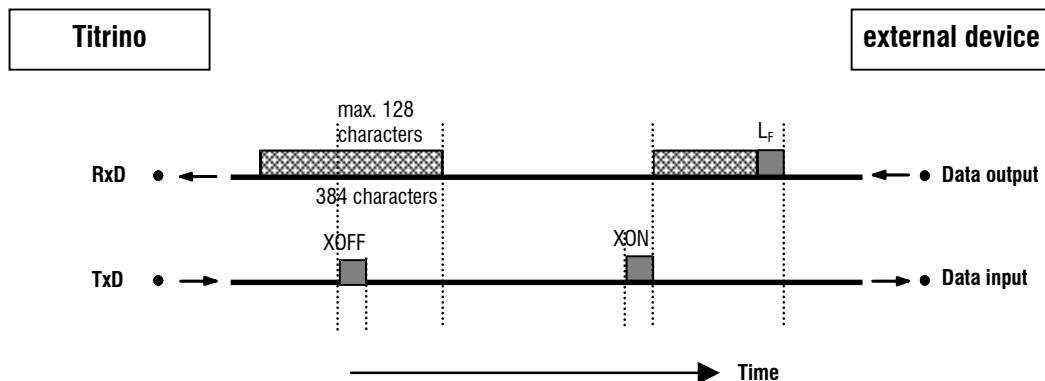

Titrimo as Sender :

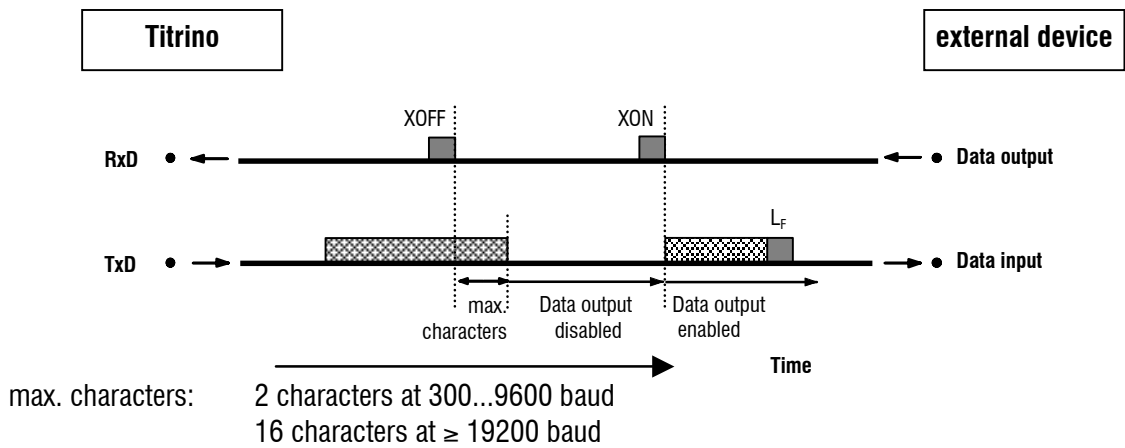

Software-Handshake, SWline

Handshake input ports on the Titrimo (CTS) are not checked.
Handshake output ports (DTR, RTS) are set by the Titrimo.
The Titrimo has an input buffer which can accept up to 512 characters.

Titrimo as Receiver :

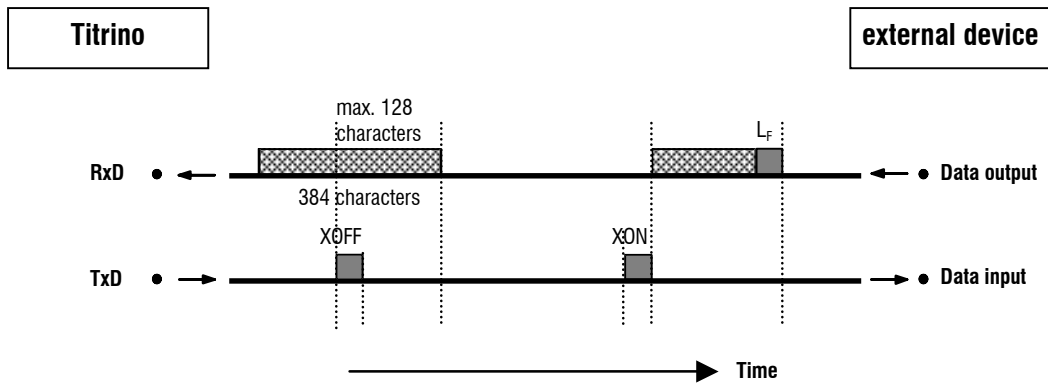

Titrimo as Sender:

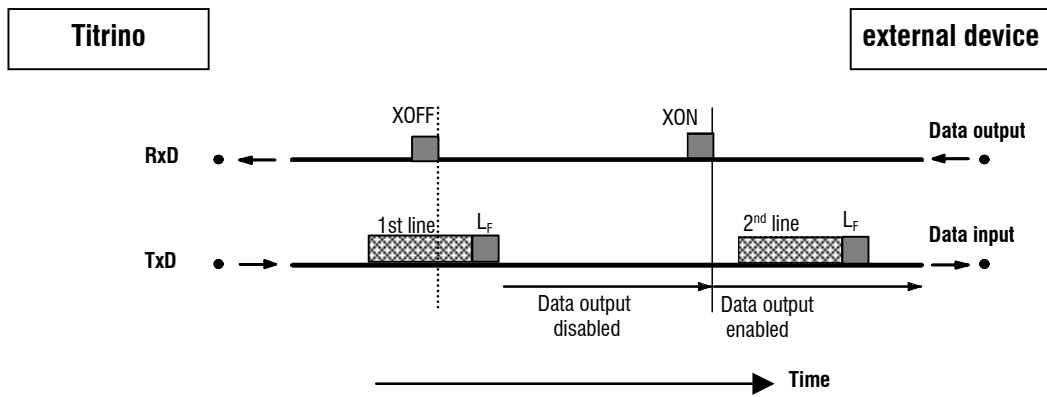

Titrimo transmission can be stopped by external instruments with XOFF. After XOFF is received the Titrimo completes sending the line already started. If data output is disabled for more than 6 s by XOFF, E43 appears in the display.

Hardware-Handshake, HWs

Titrimo as Receiver :

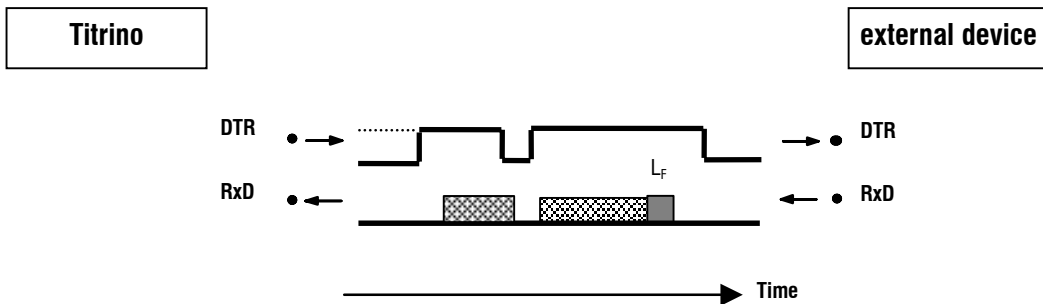

Titrimo as Sender:

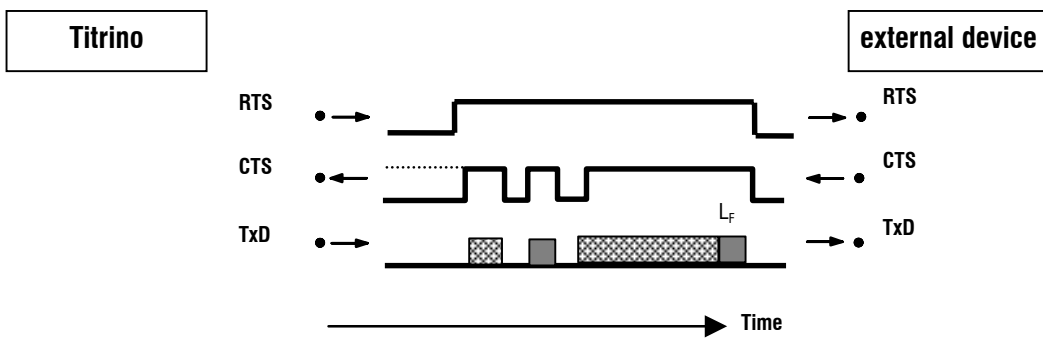

The data flow can be interrupted by deactivating the CTS line.

3.3.2 Pin Assignment

RS232C Interface

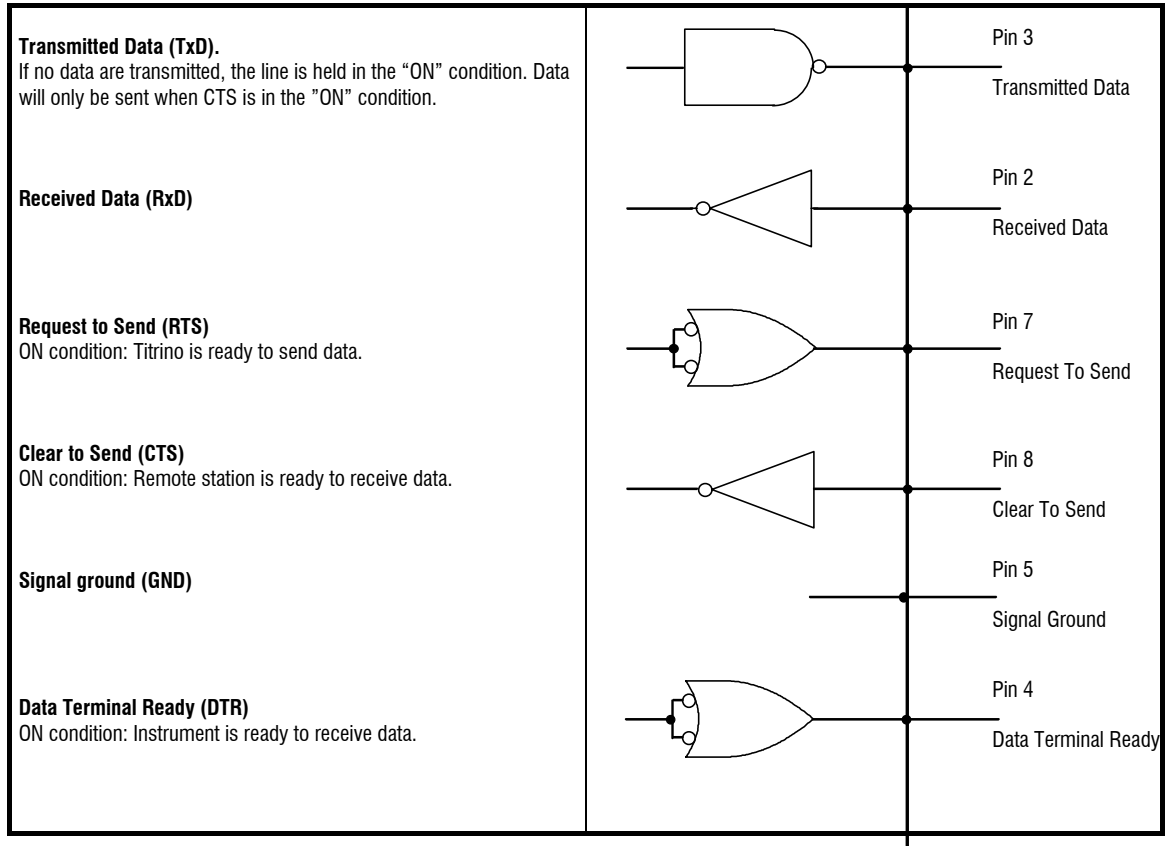

Protective earthing

Direct connection from cable plug to the protective ground of the instrument.

Polarity allocation of the signals

- Data lines (TxD, RxD)
 - voltage negative (<math>< -3\text{ V}</math>): signal state "ON"
 - voltage positive (> +3 V): signal state "ZERO"
- control or message lines (CTS, RTS, DTR)
 - voltage negative (<math>< -3\text{ V}</math>): OFF state
 - voltage positive (> +3 V): ON state

In the transitional range from +3 V to -3 V the signal state is undefined.

Driver 14C88 according to EIA RS 232C specification

Receiver 14C89 " "

Contact arrangement at plug (female) for RS 232C socket (male)

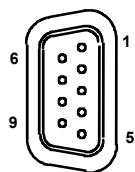

View of soldered side of plug

Ordering numbers:
K.210.0381 and K.210.9045

No liability whatsoever will be accepted for damage or injury caused by improper interconnection of instruments.

3.3.3 What can you do if the data transfer does not work?

Problem	Questions for remedial action
No characters can be received on a connected printer.	<ul style="list-style-type: none"> - Are the instruments switched on and cables plugged in correctly? - Is the printer set to "on-line"? - Are baud rate, data bit and parity the same on both instruments? - Is the handshake set properly? If everything seems to be ok, try to print a report with the key sequence <PRINT><SMPL DATA><ENTER>. If this report is printed out correctly, check if reports are defined in key <DEF>.
No data transmission and the display of the Titrino shows an error message.	<ul style="list-style-type: none"> - error 42: Transmission error. Is the printer set to "on-line"? Is the connection cable properly wired? - error 43: Data output of the Titrino disabled for longer than 6 s by XOFF. - error 36-39: Receive error. Are the RS settings the same on both devices?
The received characters are garbled.	<ul style="list-style-type: none"> - Are the RS settings the same on both devices? - Has the correct printer been selected? - Data transfer has been interrupted on the hardware side during the printout of a curve. Re-establish connections and switch printer off/on.
Wrong line spacing.	The printer does not emulate completely the preset mode. Usually these problems arise with the IBM mode. Set the printer to a different mode (e.g. Epson).
Printout of titration curve is not ok. Other reports are printed ok.	Handshake is necessary for the printout of curves. <ul style="list-style-type: none"> - Is your cable correctly wired? (The DTR of the printer has to be connected to the CTS of the Titrino.) - Set "HWs" for the handshake of the Titrino. Configure the printer such that its DTR is set (possibly with DIP switches).

4 Error messages and Troubleshooting

Data transfer inoperative See measures on page 95.

4.1 Error and special messages

XXX bytes missing	For the storage of a method or a silo line XXX bytes are missing. Remedy: <QUIT>. Delete methods no longer needed or use fewer silo lines.
check electrode	With polarized electrodes. There is a break or short circuit. Possible causes and rectification of the fault: - the electrode is not plugged in ⇒ plug it in - the electrode is not immersed in the solution ⇒ immerse it - the electrode is defective ⇒ use new electrode. - the electrode cable is defective ⇒ use new cable. The electrode test can be switched off under the <PARAM> key. Exit: Rectify fault or <STOP>.
check exchange unit!	The Exchange Unit is not mounted (properly). Exit: Mount Exchange Unit (properly) so that the coupling engages or <STOP>.
check remote box	The Remote Box is not (correctly) connected or the Remote Box is connected but not activated under the <CONFIG> key. Exit: Connect Remote Box (correctly) and set "Remote Box: ON" under <CONFIG>, >peripheral units. Switch the Titrimo off/on.
division by zero	The result could not be calculated as a divisor in the formula was equal to zero. Exit: Enter appropriate value.
error 36	Parity Exit: <QUIT> and set corresponding quantity the same on both instruments
error 37	Stop bit Exit: <QUIT> and set corresponding quantity the same on both instruments
error 38	Overrun error. At least 1 character could not be read. Exit: <QUIT>
error 39	Overflow of the receive buffer of the Titrimo (> 128 characters). Exit: <QUIT>
error 42	CTS=OFF Handshake unsatisfactory for more than 1 s. Exit: <QUIT> Is the receiver switched on and ready to receive?
error 43	The transmission of the Titrimo has been interrupted with XOFF for at least 6 s. Exit: <QUIT>.

error 45	The receive buffer of the Titrino contains an incomplete string (missing L _F). Transmission of the Titrino is thus blocked. Exit: Send L _F or <QUIT>.
manual stop	The determination has been manually stopped.
meas.pt list overflow	Maximum 500 measured points can be stored. Exit: Use start criteria or select larger time interval.
missing EP	An EP needed for calculation in a formula is missing.
no new com.var.	The common variable could not be assigned as the result or the mean value could not be calculated. The old value remains in force.
no new mean	No new mean value has been calculated as at least one quantity stipulated for mean value calculations could not be calculated.
no new silo result	No new silo result C24 or C25 could be stored as the assigned quantity could not be calculated.
no oven param.	The oven could not be found at the given COM. Remedy: connect the oven to the given RS-interface of the Titrino or set the following in your method under <PARAM>, >preselections, "Oven: no".
no titration data	No curve can be printed as no data are available.
not valid	A value is not available.
overrange	The measuring range of ± 2 V has been exceeded. Overage replaces the corresponding measured value (U or I). If a measured value is in overrange (primary or secondary measured value), the other (secondary or primary measured value) can also be unstable.
result out of limits	The result lies outside the limits which were defined in the method, see page 26. Exit: Calculate result again or new start.
sample size out	The sample size is outside the limits which are defined in the method, see page 19. Exit: Enter new sample size.
service is due	The service interval has elapsed. Contact Metrohm service so that the Titrino can be serviced. This message will appear each time the Titrino is switched on. Exit: New start.
silo empty	The silo memory is switched in but empty and a titration has been started. Corrective action: At least the first 1 silo line before starting the first titration. Exit: <CLEAR>.
silo full	The silo memory is full up. Corrective action: If you have filled less than 255 silo lines, you can create more space by deleting old methods no longer needed. 1 silo line needs 18...120 bytes. Exit: <CLEAR>.

stop V reached	The determination has been stopped as the stop volume has been reached.
system error 3	The instrument adjustment data have been overwritten. Exit: <CLEAR>. Default adjustment data are set. The error message appears each time the instrument is switched on until it has been readjusted (Metrohm service).
system error 14	No communication between the Titrino and the connected Remote Box. Possible causes: <ul style="list-style-type: none">. The Remote Box was connected when the Titrino was running. Titrino has a fault.. Remote Box has a fault. Remedy: Set under <CONFIG>, >peripheral units, "Remote Box: OFF", switch off Titrino, take away Remote Box and switch on Titrino. Contact Metrohm service.
time-out PC keyboard	A connected PC keyboard has been used to call up an address (e.g. <F12>) and the connection has then been interrupted. Possible causes: <ul style="list-style-type: none">. Remote Box has a fault.. PC keyboard has a fault. Exit: Correct fault and switch Titrino off/on.
transmission error	With a Remote Box connected characters are received which cannot be interpreted. Possible causes: <ul style="list-style-type: none">. Wrong key combination has been pressed.. Wrong PC keyboard has been selected.. The barcode reader supplies garbled characters.. The Remote Box has a fault. Exit: Rectify fault and switch Titrino off/on.
validate instrument	Validation interval has elapsed. Exit: <CLEAR> or new start.
wrong sample	With KFT with preset titration direction, the first measured value is outside the end point.

4.2 Diagnosis

4.2.1 General

The 795 KFT Titrino is a very precise and reliable instrument. Thanks to its rugged construction it is virtually impossible for external mechanical or electrical influences to have an adverse effect on its functions.

Although the occasional fault in the instrument can not be excluded completely, it is certainly much more likely that malfunctions are caused by wrong operation or handling or through improper connections and operation with non-Metrohm instruments.

It is advisable in each case to isolate the fault with the rapid and easy to perform diagnostic tests. The customer thus need not call METROHM service until there is a true fault in the instrument. In addition, with the aid of the numbering in the diagnostic program he can provide the service engineer with much more accurate information.

In inquiries always quote the manufacturing (page 5) and program number (see configuration, page 11) and specify possible error displays.

4.2.2 Procedure

- The diagnostic steps must be performed in sequence and compared with the reactions of the 795 KFT Titrino (indented). In the "yes" case, continue with the next instruction.
- If the instrument does not show the expected reaction ("no" case), the appropriate diagnostic step must be repeated to exclude an operating error. With repeated wrong reactions, however, there is a strong possibility that a malfunction exists.
- The diagnostic steps allow re-entry into the test routine for repetition if the following display appears:

diagnose press key 0...9

*If the instrument is in a subprogram of the diagnostic routine: Press <CLEAR>.
If need be, switch the power off then on again after a few seconds. At the same time press key <9> until the above display appears.*

- If <CLEAR> has been pressed during the display of '**diagnose press key 0...9**', the instrument returns to the user program.
- Error display: An error is shown in the display as follows:

error XX

↑
error number

- If a fault causes the buret drive to stick at the top or bottom end of the cylinder, see page 111, point 4.4.

4.2.3 Equipment required:

- voltage calibrator, e.g. 1.773.0010 Metrohm pH Simulator
or 1.767.0010 Calibrated Reference for mV, pH, Ω μ S, °C
- highly insulated interconnection cable 6.2108.060
- resistor switch-box, class 0.1 % (or resistor 14.3 k, 0.1 %)
- cable 3.496.5070
- exchange units, if possible with different cylinder volumes (or 3.496.0070 dummy exchange unit)
- stop watch or watch with second hand
- digital or analogue voltmeter (if need be, connect a calibrated recorder)
- 2 connecting cables with 4 mm banana plugs
- test plug 3.496.8550 (necessary only if plug 'Remote' should be checked)
- test plug 3.496.8560 (necessary only if plug 'RS 232' should be checked)

4.2.4 Diagnosis steps

1 Prepare instruments for diagnostic test

- Power off.
- Disconnect all external connections (cables at rear, except mains cable and keyboard).
- Remove exchange unit.
- Power on and immediately press and hold the **<9>** key until the powerup test pattern disappears.

diagnose press key 0...9

2 Perform display test



- Press **<2>**.

display test

- Press **<ENTER>**.

Characters for a visual check of the display are generated on the eight lines.

Test sequence:

- a) The display is cleared and overwritten from the top left to the bottom right with a dot pattern ().
- b) The display is cleared and overwritten from the top left to the bottom right with a dot pattern ().
- c) The display is continuously cleared and overwritten from the top left to the bottom right with the complete character set. At the same time with moving display the LED's „COND.“, „STATISTICS“ and „SILO“ are switches on and off.

- The test sequence can be held and then continued at any time by pressing **<5>**.
- Block 2 is quit by pressing **<CLEAR>**.

diagnose press key 0...9

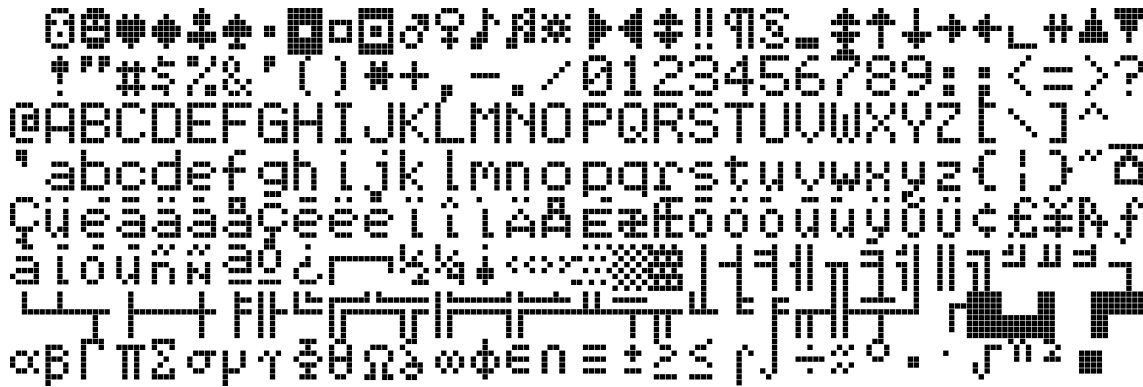

Fig. 1 Complete character set

3 Keypad test

- Press **<1>**.



- Press **<ENTER>**.

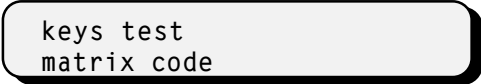

- If any key is now pressed (on the 6.2130.070 keypad or on the front panel of the 795), the appropriate matrix code appears in the display.

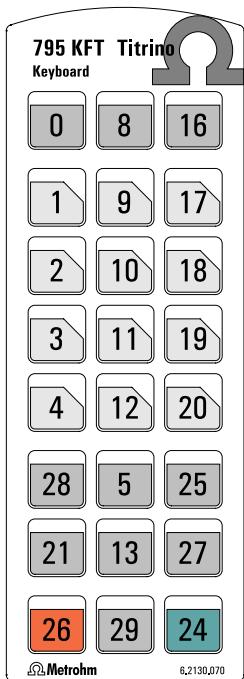

Fig. 2 Keypad 795

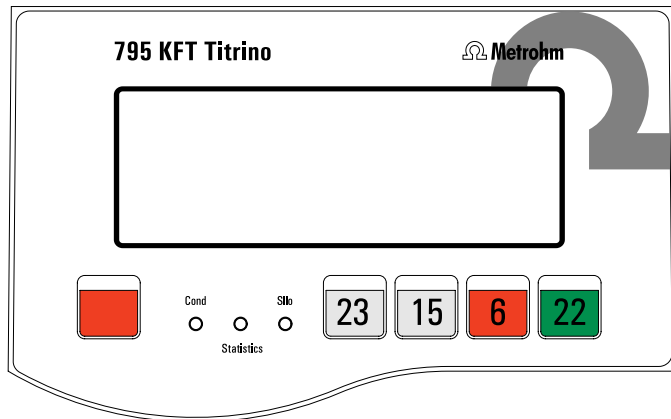

Fig. 3 Front panel 795

- Block 1 is quit by pressing the **<CLEAR>** key twice.



4 Cylinder code, date, time

- Insert exchange unit or dummy to the internal dosing unit D0 and put the buret tip into a collecting receptacle.
- Press **<0>**.

date/time
cylinder code

- Press **<ENTER>**.

activated dosing unit —

date YYYY-MM-DD	hh:mm:ss
code:D0 XX ml	

 — mL-code

- Check date and time.
- Press **<CLEAR>**.

diagnose press key 0...9

5 Motor timer test

- Press **<6>**.

motor-timer test

- Press **<ENTER>**.

pot.meter dV/dt → 10?

- Turn knob '**dV/dt**' to the right stop and press **<ENTER>**.

Test sequence:

- In a first step, the frequency of the RC oscillator (analogue rate) is tested over a period of 1 second.*
- In a second step, the frequency of the quartz oscillator (digital rate) is tested over a period of 1 second.*
- If no error is found, after about 5 s it appears*

motor-timer test o.k.

- Press **<CLEAR>**.

diagnose press key 0...9

6 Measuring input test: Polarizer test

With the aid of the "767.0010 calibrated reference for mV, pH, Ω , μS , $^{\circ}\text{C}$ " you can check the measuring input "Pol".

If a Remote Box is connected:

Deactivate the Remote Box (key <Config>, >peripheral units, Remote Box: off). Switch the Titrino off and screw off the Remote Box. Switch the Titrino on again (so that the new configuration will be recognized).

- Press <7>.

polarizer test

- Press <ENTER>.

dummy resistor 14.3 k Ω

- Screw off electrode cable (6.2104.020) and insert in socket 5 of the 767 (the cover remains closed on the 767) or connect resistor switch box (14.3 k Ω) using 3.496.5070 cable to 'Pol' socket.
- Press <ENTER>.

Test sequence:

1. An asterisk flashes during the test.
2. In case of an error an error message appears. (If for example the switch-box is not connected, **error 100** appears).
3. If no error is found, after about 15 s display shows

polarizer test o.k.

- Press <CLEAR>.

diagnose press key 0...9

- Remove 767 or cable and resistor switch-box.

7 External inputs and outputs

This test is meaningful only if the 795 KFT Titrino is used interconnected with other instruments via the 'Remote' connection or if the 6.2148.000 remote box is used for connecting a PC keyboard or a barcode reader. If the remote box should be tested, it has to be connected to the Titrino before the Titrino is switched on. In addition, a 3.496.8550 test plug normally used in the repair service is required for this test. However, this plug can also be purchased by customers under the above number.

For the sake of completeness, the procedure is described here. If a diagnostic test of the external inputs and outputs is not required, continue with point 8.

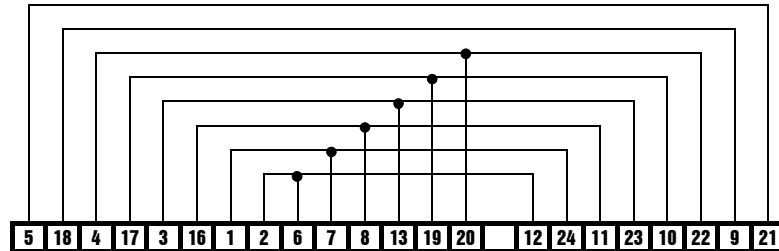

Fig. 4 Connections in the 3.496.8550 test plug

- Press **<4>**.

extern i/o test 1...2

7.1 Test of the remote interface

- Press **<1>**.

extern input/output test

- Press **<ENTER>**.

I/O-test-connector?

- Insert the 3.496.8550 test plug in port B 'Remote'. (Do not switch off instrument!)
- Press **<ENTER>**.

Test sequence:

1. In case of an error an error message is displayed. If for example no test plug is connected, error message **error 50 01HEX** appears).
2. If no error is found, after about 1 s display shows

extern input/output o.k.

- Remove test plug.
- Press **<CLEAR>**.

extern i/o test 1...2

7.2 Test of the remote box

The remote box needs to be connected before the Titrino is switched on. Insert 3.496.8550 test plug in the remote box.

- Press **<2>**.

reset remote box?

- Press **<ENTER>**.

Test sequence:

1. In case of an error an error message is displayed (for example **error 490 01HEX**).
2. If no error is found, after about 1 s display shows

remote box test o.k.

- Press **<CLEAR>**. The dialogue switches automatically to the "extern i/o test".

extern input/output test

- If this test should not be carried out (see 7.1), quit block 4 pressing **<CLEAR>** twice.
- Remove test plug.

diagnose press key 0...9

8 RS 232 test

A 3.496.8560 test plug normally used in the repair service is required for this test. However, this plug can also be purchased by customers under the above number.

For the sake of completeness, the procedure is described here. If a diagnostic test of the RS 232 interface is not required, continue with point 9.

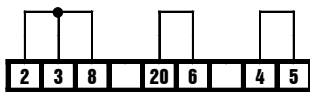

Fig. 5 Connections in the 3.496.8560 plug

- Press **<5>**.

RS232 test 1...2

8.1 RS232 test 1

- Press <1>.

RS232 test-connector? 1

- Insert the 3.496.8560 test plug in port 'A1'.
- Press <ENTER>.

Test sequence:

1. In case of an error an error message is displayed. If for example no test plug is connected, error message **error 69** appears).
2. If no error is found, after about 5 s display shows

RS232 test 1 o.k.

- Remove test plug.
- Press <CLEAR>.

RS232 test 1...2

8.2 RS232 test 2

- Press <2>.

RS232 test-connector? 2

- Insert the 3.496.8560 test plug in port 'A2'.
- Press <ENTER>.

Test sequence:

1. In case of an error an error message is displayed. If for example no test plug is connected, error message **error 69** appears)
2. If no error is found, after about 5 s display shows

RS232 test 2 o.k.

- Remove test plug.
- Press <CLEAR>.

RS232 test 1...2

- Press <CLEAR>.

diagnose press key 0...9

9 Internal dosing unit

- Remove exchange unit.
- Check spindle zero position, see Fig. 5.

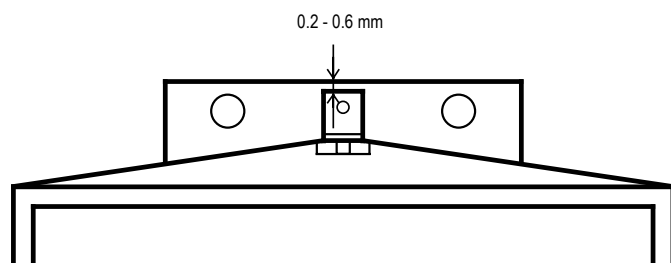

Fig. 6

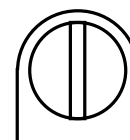

Fig. 7

The spindle must be 0.2 – 0.6 mm below the edge of the sliding plate.

The bar of the stopcock coupling must be exactly parallel to the lateral edges of the KFT Titrino, see Fig.6.

- Reinsert Exchange Unit.
Titrimo fills.
The display of before reappears.
- Knob '**dV/dt**' to right stop.
- Press the **<DOS>** key (on instrument) until the piston rod reaches the top and at the same time measure the time from start to end.



Spindle remains at maximum position. The transit time of the spindle is 20 s.

- Measure spindle lifting (can be performed only if the 3.496.0070 Dummy Exchange Unit is inserted or the locking switch (in right hole) is carefully operated with a screwdriver after removal of the Exchange Unit).

From the start point, the spindle travels 80 mm. Instead of the spindle height, the expelled volume can be measured (corresponds to max. vol. of Exchange Unit used).

- Press **<FILL>** (on instrument) and simultaneously measure the time until the KFT Titrino is again in the 'ready' position.

Times for filling:	per stop cock cycle	1 s
	for filling	20 s (Tolerance: 10 %)

The following generally holds: Spindle and stopcock must move at a constant speed (noise!). In the filling setting, the stopcock coupling must position the lever of the Exchange Unit correctly at the left stop (with virtually no play and without sticking).

- Set potentiometer '**dV/dt**' to left stop.
- Press **<DOS>** (on instrument) at same time and use a stopwatch to measure the time for 1/10 of the cylinder volume to be expelled. The time should be ca. 90...110 s.
- Set potentiometer '**dV/dt**' to right stop.
- Press **<FILL>**.

10 Setting up original arrangement

Reconnect all peripherals disconnected at the start of the diagnostic routine and perform a short function test with these.

4.3 Initialize and test RAM

On the odd occasion large disturbing signals (e.g. mains spikes, lightning, etc.) can have an adverse effect on the processor functions and hence lead to a system crash. After such a crash the RAM area must be initialized. Although the basic instrument data remain stored, the RAM initialization should be performed only when necessary since the stored user data (configuration, parameters, calculation variables, etc.) are cleared as a result.

- Power OFF
- Power ON and simultaneously press keys **<DOS>** and **<STOP/FILL>**.



RAM Init.

- Press **<START>**.



confirm RAM Init.

- Press **<START>**.



RAM Init. activ

RAM is tested and initialized. Subsequently a warm start is executed.

The lost data of the user memory must now be reentered.

If '**system error 3**' appears in the display, **<CLEAR>** can be used to return to the instrument program. The initialization values are loaded automatically. The instrument thus remains capable of measurement. However, possibly a small loss in accuracy must be anticipated. A new optimum adjustment can be performed by Metrohm service. The error message '**system error 3**' always appears after the instrument is switched on until this adjustment has been performed.

4.4 Releasing a locked spindle with inserted Exchange Unit

- The buret drive may very occasionally jam at the top or bottom end of the cylinder. If jamming occurs at the top or when the drive is out of function, the Exchange Unit can no longer be removed. In this case, it is necessary to proceed as follows:

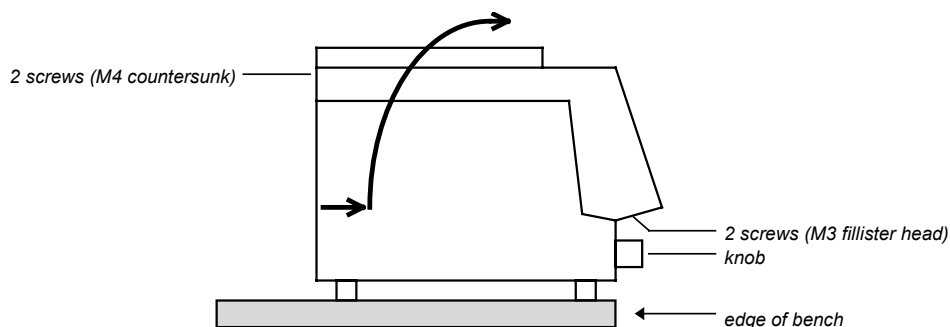

Fig. 8

- Disconnect instrument from power supply!
- Remove control knob.
- Place instrument over edge of bench to allow the M3 screws to be removed (Fig. 7).
- Remove M4 screws.
- Lift off top part of instrument together with Exchange Unit in the manner shown by the arrow.



**The electronic circuits are now accessible!
On no account touch these!**

- Remove spindle from mechanical stop by turning the large gear wheel. (In case that the motor is inoperative, position spindle by hand to zero position.)

5 Preparations

The mains cables supplied with the instrument are three-core and equipped with a plug with an earthing pin. If a different plug has to be fitted, the yellow/green lead must be connected to the protective earth. Each break in the earthing inside or outside the instrument can make it a hazard.



When the instrument is opened or if parts of it are removed, certain components may be live if the instrument is connected to the mains. The mains cable must therefore always be unplugged when certain adjustments are made or parts replaced.

When peripheral instruments are connected to the KFT Titrino, the Titrino and the instruments to be connected have to be switched off, otherwise all instruments could suffer damage!

Before connecting a printer or a balance to the RS232 Interface, switch off the Titrino!

5.1 Setting up and connecting the instruments

5.1.1 Titrino with Stirrer or Titration Stand

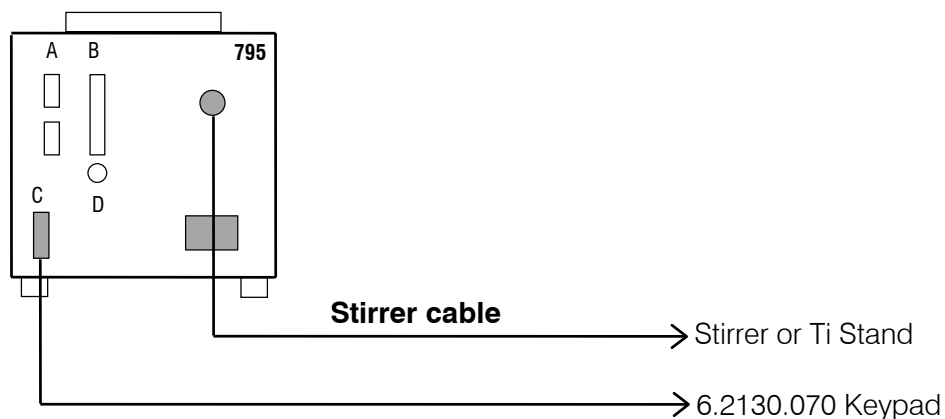



The 802 Rod Stirrer, the 727, or the 703 Ti Stand with 6.2108.100 cable can also be connected instead of the 728 Magnetic Stirrer.

5.1.2 Connection of a printer

A variety of printers can be connected to the RS232 interface of the Titrimo. If you connect a printer other than one of those mentioned below, ensure that the Epson mode is emulated or that it uses the international character set following the IBM Standard Table 437 and IBM-compatible graphics control characters.

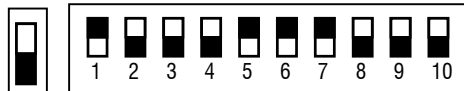
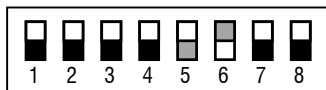
If a balance is connected at the same COM of the Titrimo as a printer, you need the 6.2125.010 + 6.2125.030 Adapters.

Printer	Cable	Settings on Titrimo	Settings on Printer
Seiko DPU-414	6.2134.110	baud rate: 9600 data bit: 8 stop bit: 1 parity: none handshake: HWs send to: Seiko	none
Custom DP40-S4N	6.2134.110	baud rate: 9600 data bit: 8 stop bit: 1 parity: none handshake: HWs send to: Citizen	none, pre-set on Metrohm version IDP-560 EMULATION FONT MAP =GERMANY PRINT=REVERSE LITTLE CR CODE=VOID CR AFTER B :FULL=VOID CR ON b. EMPTY=VALID BUFFER 1K BYTE BAUD RATE=9600 PROTOCOL=8,N,1 FLOW CONTROL CTS-RTS
Citizen iDP562 RS	6.2134.050	baud rate: 9600 data bit: 8 stop bit: 1 parity: none handshake: HWs send to: Citizen	ON  SSW1
Epson LX-300+	6.2134.050	as above, but send to: Epson	see printer manual
HP Desk Jet with serial interface	6.2134.050	baud rate: 9600 data bit: 8 stop bit: 1 parity: none handshake: HWs send to: HP	A:  B4 Paper B: 
HP Desk Jet with parallel interface	2.145.0330 RS232/ Parallel Converter	baud rate: 9600 data bit: 8 stop bit: 1 parity: none handshake: HWs send to: HP	see printer manual

5.1.3 Connection of a balance

The following balances can be connected to the RS232 output of the Titrino:

Balance	Cable
Sartorius MP8, MC1	6.2134.060
Shimadzu BX, BW	6.2125.080+6.2125.010 Settings on Titrino: balance SARTORIUS Balance: delimiter CR+LF
Ohaus Voyager, Explorer, Analytical Plus	from Ohaus: AS017-09 (Ohaus parts number) Settings on Titrino: balance SARTORIUS Balance: SET BALANCE INTERFACE BAUD RATE 9600 DATA BITS 8 PARITY none STOP BITS 1
Mettler AB, AG (LC-RS25)	in the scope of delivery of the balance
Mettler AM, PM	6.2146.020 + 6.2125.010 additionally from Mettler: ME 47473 Adapter and ME 42500 hand switch or ME 46278 foot switch
Mettler interface 016	Cable in scope of delivery of interface 016: Red lead to pin 3, white lead to pin 7 of the 25-pin connector + 6.2125.010 25 Pol/9 Pol Adapter
Mettler interface 011 or 012	6.2125.020 + 6.2125.010
Mettler AT	6.2146.020 + 6.2125.010
Mettler PG, AB-S	6.2134.110
Mettler AX, MX, UMX	6.2134.120
AND Models ER-60, 120, 180, 182 Models FR-200, 300 Models FX-200, 300, 320 with RS232 interface (OP-03)	6.2125.020 + 6.2125.010
Precisa, balances with RS232C-interface	6.2125.080 + 6.2125.010

The balance type must be preselected at the Titrino with the <CONFIG> key.

The weight is transferred as a number with up to 6 digits, sign and decimal point. Units and control characters sent by the balance are not transmitted.

With the aid of a special input unit supplied by the balance manufacturer, in addition to the weight identifications and methods can be

inputted from the balance. For this, the address of the identifications and method, resp. must be preselected on the input unit.

Balance	Method	Id1	Id2	Id3
Sartorius	METH or 27	ID.1 or 26	ID.2 or 24	C-20 or 23
Mettler (AT)	D (Mthd)	C (ID#1)	B (ID#2)	A (c20)

If balance and printer are connected at the same Titrimo COM you need the 6.2125.010 and 6.2125.030 Adapters.
 If the balance works only with 7 bit and the printer with 8 bit and if they are at the same Titrimo COM, the balance has to bet to "space parity" and Titrimo/printer to 8 bit, "no parity".

5.1.4 Connection of a KF Oven

It is expedient to place the oven on 6.2041.180 instrument bridge.
 Take care that the gas outlet of the oven enters the titration vessel as directly as is possible to prevent the formation of condensed water in the outlet tubing.

Oven on 6.2041.180 instrument bridge



Connection of both RS interfaces (cable 6.2125.110) is only necessary when you require the oven results in the 795 Titrimo report. Make sure there is no report output from the oven!

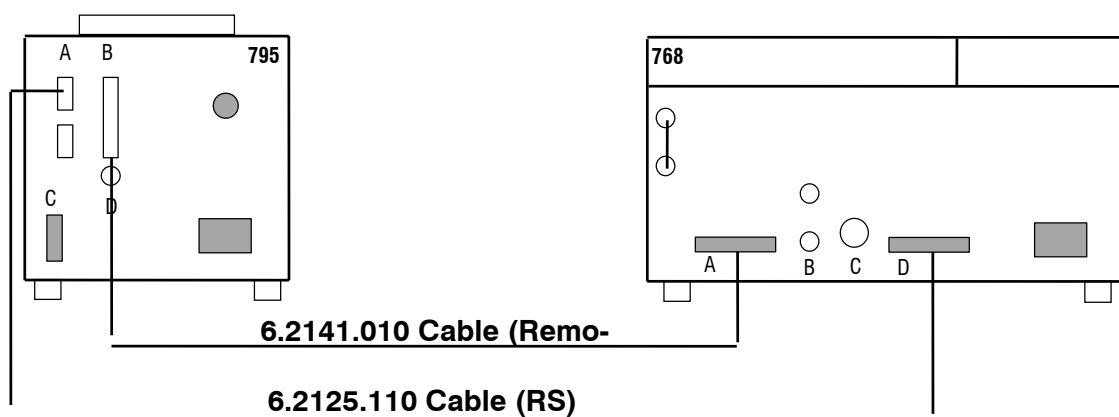

When the RS interfaces are not connected then the following setting must be made at the Titrino: <PARAM>, >preselections, "Oven: no".

If you enter one of the COMs of the Titrino for this parameter then your Titrino result report will contain the oven data "heating time", "sample temp.", "lowest temp.", "highest temp." and "gas flow". The start is triggered at the oven. When the Titrino titration vessel has been conditioned the oven automatically starts the titration.

The 707 KF Oven can also be connected instead of the 768 KF Oven.

5.1.5 Connection of a Sample Changer

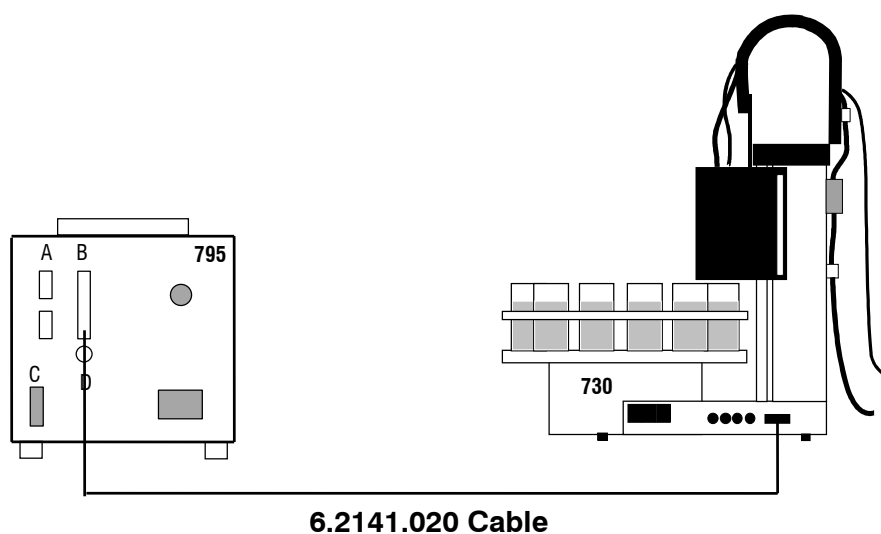

With 6.2141.030 cable (instead of 6.2141.020), two Titrinos can be connected to the 730 (or 760) Sample Changer at the same time.

- The "Remote" socket allows not only connection of a sample changer but also additional control functions. Pin assignment of the "Remote" socket and control possibilities, see page 125.
- If a calibration has to be performed with the sample changer, the calibration parameter "sample changer:" must be set to "ON".
- In connections with the sample changer, "auto start" should be set to "OFF" in the <CONFIG> key. The start command is given by the Sample Changer.

5.1.6 Connection of the 774 Oven Sample Processor

The Oven Sample Processor heats the sample and transfers the moisture from the sample to the titration vessel of the Titino. Titrimo and Oven Sample Processor are connected via the remote sockets (cable 6.2141.020) as well as via the RS interfaces (cable 6.2125.110)

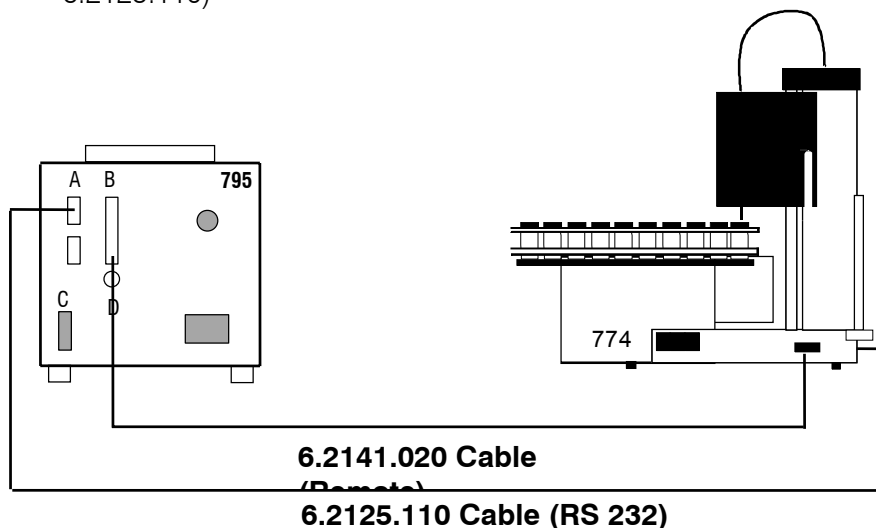

- The "Remote" socket allows not only connection of a sample changer but also additional control functions. Pin assignment of the "Remote" socket and control possibilities, see page 125.
- In connections with the oven sample processor, "auto start" should be set to "OFF" in the <CONFIG> key. The start command is given by the oven sample processor.

In addition, while a sequence is being processed, the 774 Oven Sample Processor can, via the serial RS interface, cause the 795 Titrimo to load a particular method. The Titrimo can obtain the oven parameters via the RS connection.

5.1.7 Connection of a computer

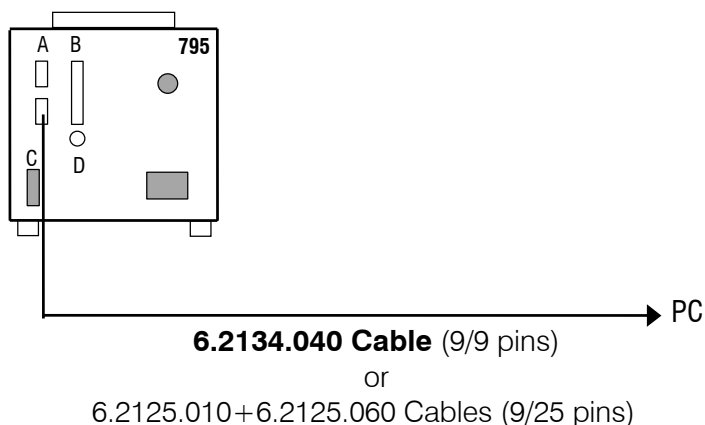

Preselections on the Titrimetric Instrument:

RS232 settings: depend on the control program of the computer
 Send to: IBM
 Vesuv 3.0, PC program for data acquisition and method backup
 for up to 64 devices 6.6008.200
 for 2 devices..... 6.6008.500

5.1.8 Connection of a Remote Box

A barcode reader and/or a PC keyboard can be connected to 6.2148.000 Remote Box.

The barcode reader and PC keyboard are used as input aids.

Only plug in and unplug the Remote Box when the Titrimetric Instrument is switched off! The Remote Box is screwed onto the "Remote" socket of the Titrimetric Instrument. The remote lines of the Titrimetric Instrument are then accessible at the "Remote" socket of the Remote Box.

5.1.8.1 Connecting a barcode reader

Barcode readers with a 5-pole DIN plug can be connected to 6.2148.000 Remote Box. A precondition is that the barcode reader can emulate a PC keyboard. If a barcode reader and a PC keyboard are to be connected at the same time then the barcode reader must have a T-connection plug. The PC keyboard will then be plugged into this barcode reader connection.

Settings at the Titrino:

Under key <CONFIG>, >peripheral units, "Remote Box: on"

Barcode:

- input** The barcode string goes to the entry field in which the cursor is currently located.
- method** If the silo memory is switched on the barcode string always goes to the method. The cursor position has no effect.
If the silo memory is switched off the input has no meaning.
- id1** The barcode string always goes to Id1. The cursor position has no effect.
- id2, id3** As for id1.
- smp1 size** The barcode string always goes to the sample size. The cursor position has no effect. If the silo memory is switched on the silo line will be concluded with the sample size and the cursor moves to the next silo line.

Settings at the barcode reader:

Plug the barcode reader into the Remote Box. The barcode reader instruction manual contains the codes which you must enter.

1. Bring the barcode reader into the programming mode.
2. Make the necessary setting for emulating a PC keyboard (may be country-specific).
Select <ENTER> or "CR + LF" as termination sign.
3. Exit the programming mode.

Notes:

- If longer characters chains than are permitted by the corresponding input are transmitted then the first n characters will be accepted; the last characters will be cut off.
- If the silo memory is switched on and the settings "barcode: method" or "barcode: idX" are operative, the first silo line will be created when the string is received. Higher silo lines than 1 are only created and concluded with the sample size.

5.1.8.2 Connecting a PC keyboard

PC keyboards with a 5-pole DIN plug can be connected to 6.2148.000 Remote Box. For keyboards with a PS/2 plug an adapter PS/2→DIN is available in PC shops.

Settings at the Titrino:

Under key <CONFIG>, >peripheral units, "Remote Box: on"

Keyboard:

Select the country-specific keyboard layout of your PC keyboard.
If the Titrino does not support your keyboard you should select a keyboard which has the closest possible layout (for example check the 2nd occupancy of the numerical keys).
Country-specific special characters will probably not be converted correctly.

5.1.8.3 Operating via a PC keyboard:

The Titrino can be operated from the PC keyboard. The Titrino functions are called up as follows:

Titrimo function	Key combination on PC keyboard	Remarks
<C-FMLA>	Alt F	
<CLEAR>	F5	
<CONFIG>	F10	
Cursor ↑ ↓	Cursor ↑ ↓	Navigation, move the cursor along the curve
Cursor → ←	Cursor → ←	Selection of inputs Change between result display and display of the curve (<CURVE>)
<DEF>	Alt D	
DEF: formula input, common variable, mean value: EP RS MN C	E R M C	Input of corresponding quantity or variable together with the numerical address, e.g. R1 gives RS1.
<ENTER>	enter	
<MEAS/HOLD>	F9	
<MODE>	F2	
<PARAM>	F11	
<PRINT>	Alt P	Report selection with → ←
<QUIT>	ESC	
<REPORTS>	Alt O	Printout reports: Alt P + Alt O
<SILO>	F4	on/off
<SMPL DATA>	F12	
<START>	F7	
<STATISTICS>	F6	on/off
<STOP>	F8	
<USER METH>	F3	
<USER>	Alt U	

The numerical block (with NumLock) and the number keys on the PC keyboard simulate the functions of the numerical keys on the Titrino. For example, entering <7> in the basic state of the Titrino switches the statistics on.

Keys which are used for setting an accent (e.g. ^, ´) are converted immediately. If you try to enter ê the Titrino will display ^e instead.

The occupancy of the PC function keys is shown to the right as an overlay. You can copy this diagram, cut out the central part and place it above the function keys of your PC keyboard.

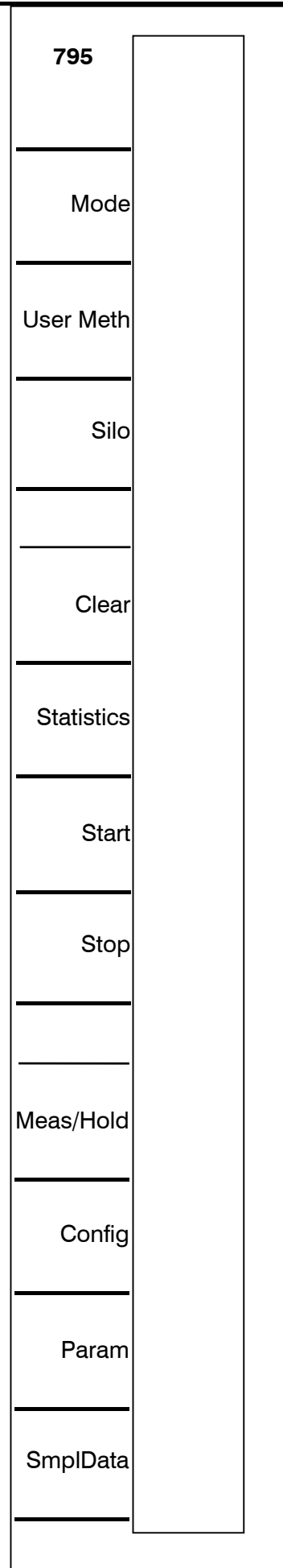

5.2 Connection of electrodes and preparing titration vessel

The Titrino 795 has one measuring input.

Rear panel:



Pol

Pol Connection of polarized electrodes.
If measured quantities I_{pol} or U_{pol} are selected, this measuring input is automatically active.

Setting up the KF titration vessel

For volumetric KF titrations install the titration vessec according to the following figure:

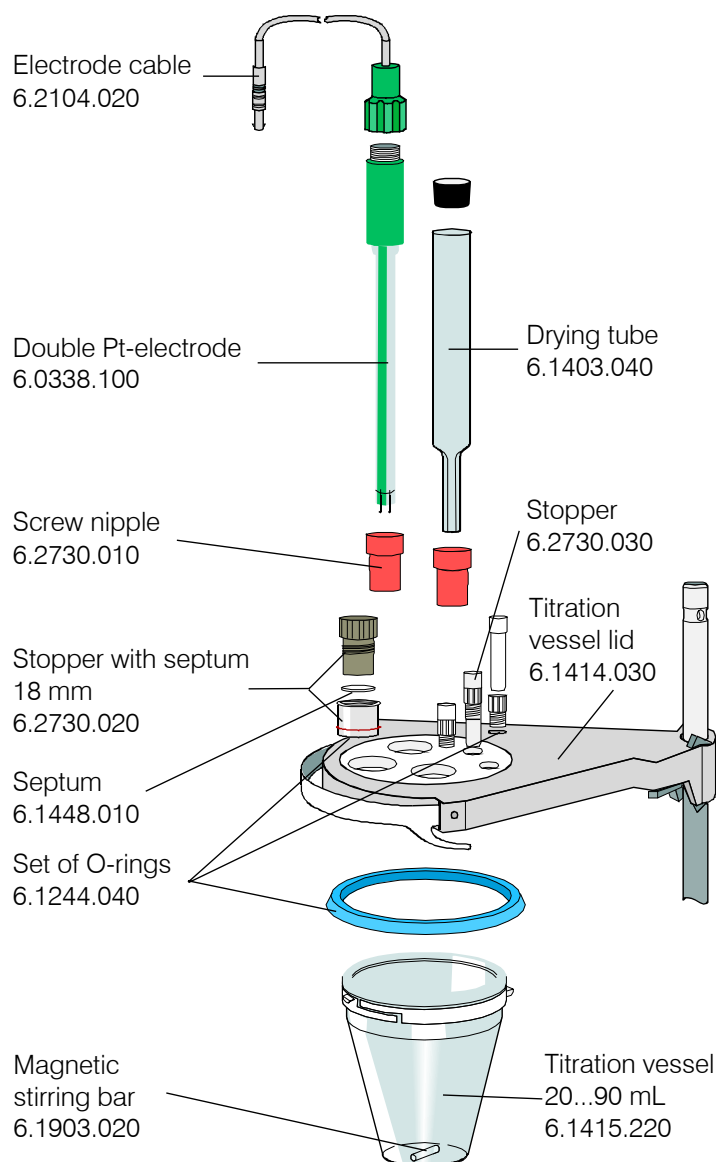

6 Appendix

6.1 Technical specifications

Modes	KFT: K arl F isher T itration for water determination
Measuring inputs	1 measuring input for polarized electrodes.
Measuring range	
Voltage	0...±2000 mV, resolution 1 mV, error limit 0.1 % full scale
Current	0...±200.0 µA, resolution 1 µA
Water content	a few ppm to 100 %
Polarizer	Ip _{ol} : 0...±127 µA, resolution 1 µA Up _{ol} : 0...±1270 mV, in steps of 10 mV
Dosification	
Volume of buret cylinder	1, 5, 10, 20 or 50 mL
Resolution	10 000 steps per buret cylinder
Titrating burets	1 internal buret
Auxiliary burets	1 additional buret: 765 or 776 Dosimat
Materials	
Housing	Polybutyleneterephthalate (PBTP)
Keypad cover	Polycarbonate (PC)
Display	Graphical LCD, 192 x 64 Dots Field: 100 x 37 mm LED back-lit
Memory	Method memory for up to 100 methods Data bank with 18 Metrohm methods Silo memory for sample data and results
RS232 interface	2 separate interfaces, each can be configured for printer, balance or computer connection: completely controllable from external control unit
Remote input/output lines	for Sample Changer, robot connection, oven, ultra turax... With optional Remote Box: Connection of barcode reader and PC keyboard.

Stirrer control	Switch the stirrer on/off either manually or coordinated with the titration sequence
Ambient temperature	
Nom. operation range	5...40 °C
Storage	-20...60 °C
Transport	-40...60 °C
Safety specifications	Designed and tested in accordance to IEC publication 1010, safety class I. This manual contains information and warnings which have to be followed by the user to ensure safe operation and to retain the apparatus in safe condition.
Mains connection	
Voltage	100...240 V
Frequency	50...60 Hz
Power consumption	15 W
Fuse	2 x 1 ATH (to be replaced by Metrohm Service only using the same type) Additional electronic overload protection
Dimensions with Exchange Unit	
Width	150 mm
Height	450 mm
Depth	275 mm
Weight , incl. keypad	app. 3.6 kg

6.2 Pin assignment of the "Remote" socket

	external	Function
Inputs 	pin 21 (Input 0)	Start
	pin 9 (Input 1)	Stop
	pin 22 (Input 2)	Enter
	pin 10 (Input 3)	Clear
	pin 23 (Input 4)	Sample ready
	pin 11 (Input 5)	not used
	pin 24 (Input 6)	
	pin 12 (Input 7)	

Outputs 	pin 5 (Output 0)	Ready inactive
	pin 18 (Output 1)	Conditioning ok, active if Cond.ok
	pin 4 (Output 2)	Titration, active during titration

	Functions see page 127.
Not used in titration sequences	

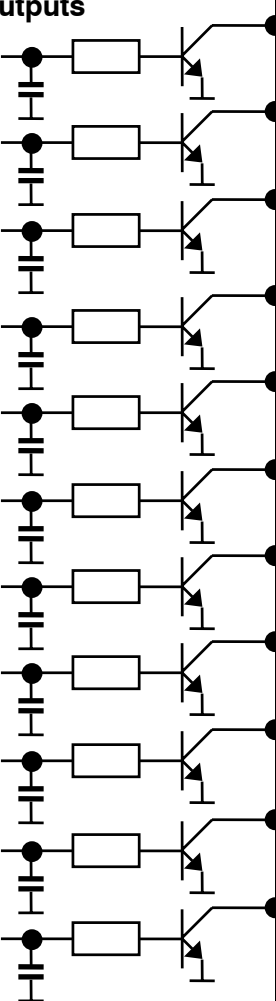
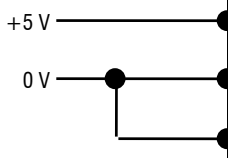
<p>Outputs</p> 	<p>pin 17 (Output 3)</p> <p>pin 3 (Output 4)</p> <p>pin 16 (Output 5)</p> <p>pin 1 (Output 6)</p> <p>pin 2 (Output 7)</p> <p>pin 6 (Output 8)</p> <p>pin 7 (Output 9)</p> <p>pin 8 (Output 10)</p> <p>pin 13 (Output 11)</p> <p>pin 19 (Output 12)</p> <p>pin 20 (Output 13)</p>	<p>End of determination EOD</p> <p>not used</p> <p>Error, active with errors</p> <p>Activate pulse, see page 127. L6 in TIP</p> <p>Pulses for recorder ($t_p = 150 \mu\text{s}$) 10 000 per buret cylinder</p> <p>not used</p> <p>not used</p> <p>not used</p> <p>not used</p> <p>not used</p> <p>not used</p> <p>sample size out of limits</p> <p>result out of limits, see page 26</p> <p>For all outputs: $V_{CE0} = 40 \text{ V}$ $I_C = 20 \text{ mA}$ $t_{\text{Pulse}} > 100 \text{ ms}$ Functions see page 127.</p>
<p>Voltage</p> 	<p>pin 15</p> <p>pin 14</p> <p>pin 25</p>	<p>$I \leq 200 \text{ mA}$</p> <p>0 V: active 5 V: inactive</p>

Ordering numbers for plug:
K.210.9004 (shell) and K.210.002

No liability whatsoever will be accepted for damage caused by improper interconnection of instruments.

6.2.1 Lines of the "Remote" socket during the titration

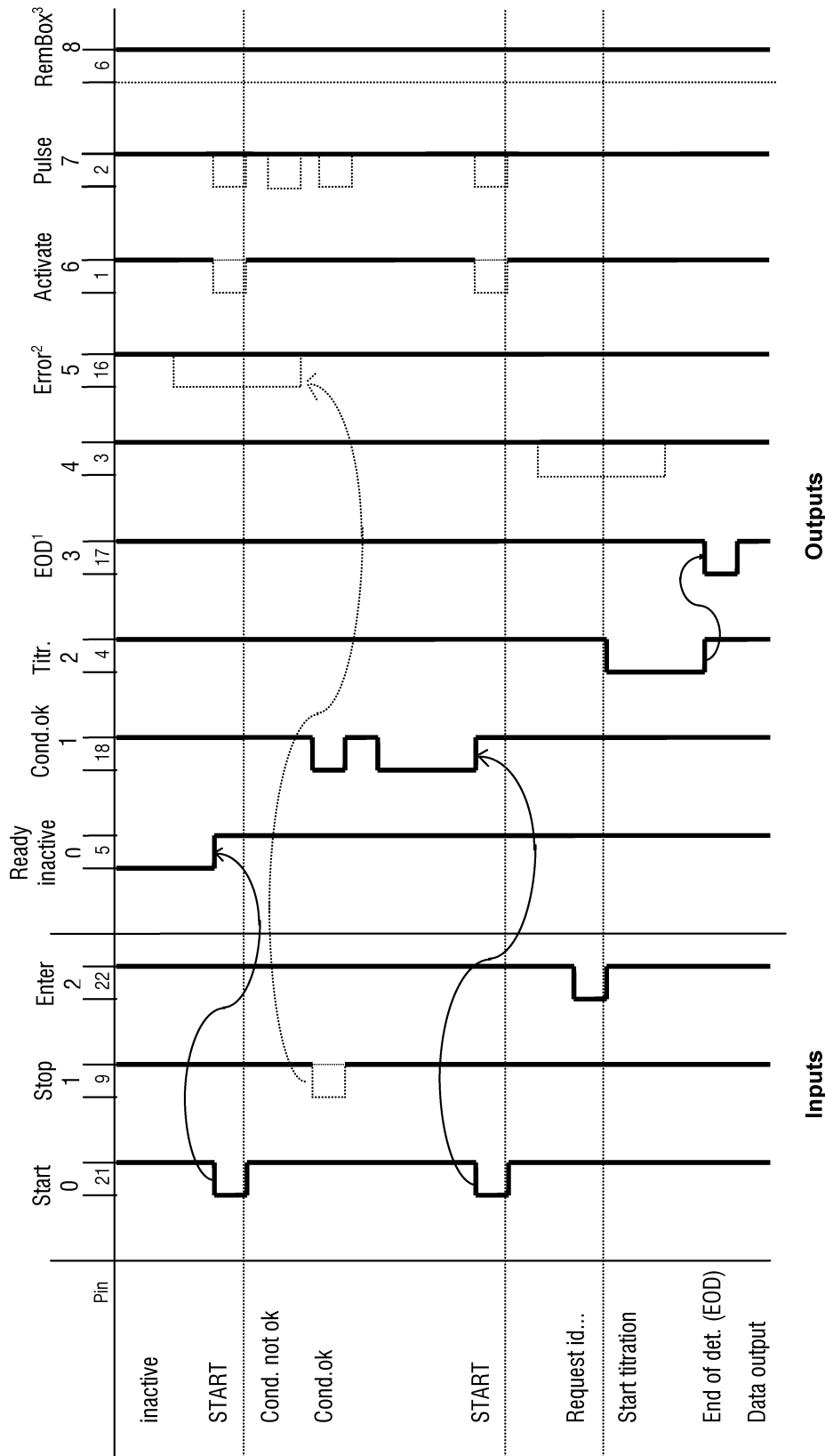

- 1: Automatic output of EOD can be switched off via RS232, see page 84.
- 2: The error line is reset when the error is rectified.
- 3: Line is active if a remote box is registered, see page 10.

6.2.2 Possible configurations of the activate pulse KFT

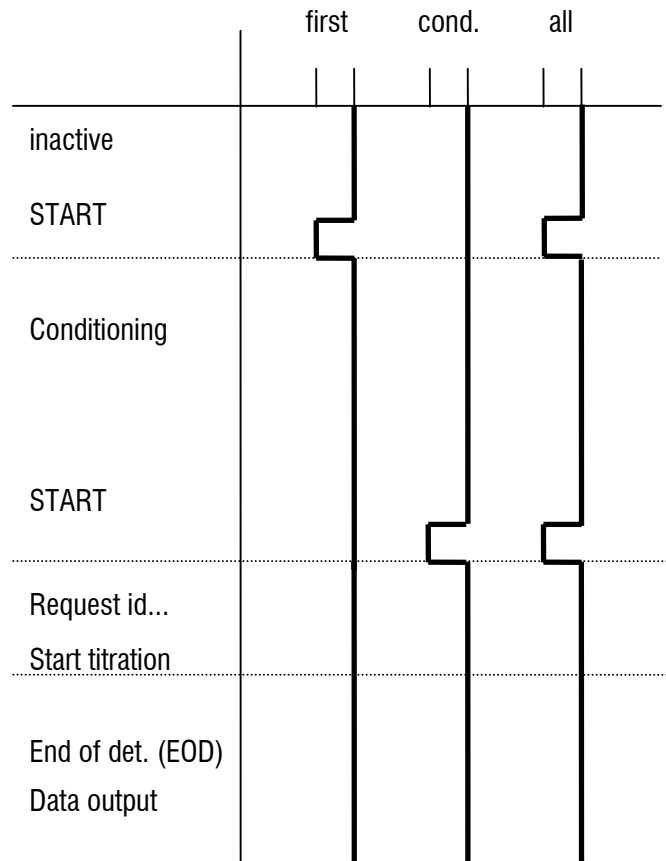

6.3 User methods

6.3.1 General

The methods are stored in the user memory ready for use. They can be loaded, modified and overwritten.

Connect the printer to COM1 of the Titrino. If you have no printer connected, you have to delete the reports under the key <DEF>, >report.

If the result should have another unit, you need to adjust the calculation constants using the key <C-FMLA>.

The following methods are available:

'um			
795	KFT Titrino	01103	795.0010
user		pk1	
date	2001-11-15	time	17:50
user methods		bytes	
KFT	Ipo1	H2OTiter	152
KFT	Ipo1	TarTiter	152
KFT	Ipo1	Blank_KF	134
KFT	Ipo1	KF-Blank	208
KFT	Ipo1	KF	172
KFT	Ipo1	5Titer	152
KFT	Ipo1	5Deter	172
KFT	Ipo1	5Deter-B	208
KFT	Ipo1	2Titer	152
KFT	Ipo1	2Deter	172
KFT	Ipo1	2Deter-B	208
KFT	Ipo1	1Titer	152
KFT	Ipo1	1Deter	172
KFT	Ipo1	1Deter-B	208
KFT	Ipo1	KetTiter	152
KFT	Ipo1	KetDeter	172
KFT	Ipo1	KetDet-B	208
KFT	Ipo1	BrNumber	212
remaining bytes		96716	
.....			

- KF-titer with H₂O or methanol standard
 - KF-titer with sodium tartrate
 - Blank determination for KFT
 - KF-titration with blank value subtraction
 - KF-titration without blank value subtraction
 - KF-titer
 - KF-titration without blank value subtraction
 - KF-titration with blank value subtraction
 - KF-titer
 - KF-titration without blank value subtraction
 - KF-titration with blank value subtraction
 - KF-titer
 - KF-titration without blank value subtraction
 - KF-titration with blank value subtraction
 - KF-titer
 - KF-titration without blank value subtraction
 - KF-titration with blank value subtraction
 - Bromine number according ASTM D 1159-84
- for KF reagent 5 mg/mL H₂O
- for KF reagent 2 mg/mL H₂O
- for KF reagent 1 mg/mL H₂O
- for special ketone/aldehyde KF reagent

6.3.2 KF Titer determination with H₂O or methanol standard "H2OTiter"

```
'pa
795 KFT Titrino          795.0010
date 2001-11-15      time 17:58      0
KFT Ipol              H2OTiter
parameters
>control parameters
  EP at U                250 mV
  dynamics                100 mV
  max.rate                max. ml/min
  min.volume incr.       min. µl
  stop crit:              drift
  stop drift              20 µl/min
>titration parameters
  titr.direction:        -
  pause 1                 0 s
  start V:                 OFF
  pause 2                 0 s
  extr.time               0 s
  I(pol)                  50 µA
  electrode test:         OFF
  temperature              25.0 °C
  time interval           2 s
>stop conditions
  stop V:                  abs.
  stop V                   99.99 ml
  filling rate             max. ml/min
>statistics
  status:                  ON
  mean                     n= 5
  res.tab:                  original
>preselections
  conditioning:            ON
  display drift:           ON
  drift corr:              OFF
  req.ident:               OFF
  req.smpl size:           value
  limit smpl size:        OFF
  oven:                    no
  activate pulse:         OFF
  -----

'fm
795 KFT Titrino          795.0010
date 2001-11-15      time 17:59      0
KFT Ipol              H2OTiter
>calculations
Titer=C00/EP1*C01;4;mg/ml
C00=                    1.0
C01=                    1000
  -----

'de
795 KFT Titrino          795.0010
date 2001-11-15      time 17:59
KFT Ipol              H2OTiter
def
>formula
  Titer=C00/EP1*C01
  RS1 text                Titer
  RS1 decimal places       4
  RS1 unit:                 mg/ml
  RS1 limit control:       OFF
>silco calculations
  match id:                OFF
>common variables
  C39=MN1
>report
  report COM1:full;
>mean
  MN1=RS1
>temporary variables
  -----
```

The titer is calculated as mean value of 5 single determinations and stored as common variable C39. Therefore, it can be directly used in subsequent methods.

Electrode:

Double Pt-electrode 6.0338.100 at measuring input "Pol".

Titration agent:

One-component or two-component Karl-Fischer reagent, ready to use.

Solvent:

20 mL Methanol or a specific solvent, conditioned.

Sample:

Distilled water, approx. 10 µL or methanol standard (5 or 10 mg water/mL).

References:

G. Wieland, Water determination by Karl Fischer Titration, GIT Verlag, Darmstadt, Germany
 HYDRANAL® Practical Course, Water reagents for Karl-Fischer-Titration according to Eugen Scholz, Riedel de Haën, Seelze, Germany
 METROHM Application Bulletin No. 77: Karl Fischer Water Determinations

- Result in mg/mL
- Sample size in g
- Factor

The factor depends on type and water content of the standard:

Standard used	Sample size in	Factor
water	g	1000
water	µL	density (H ₂ O) = 1 g/mL
methanol	g	water content in mg/g
methanol	mL	water content in mg/mL
methanol	µL	0.001 * water content in mg/mL

C39 is the common variable for the titer

6.3.3 KF Titer determination with sodium tartrate "TarTiter"

```
'pa
795 KFT Titrino          795.0010
date 2001-11-15      time 14:56      0
KFT Ipol              TarTiter
parameters
>control parameters
  EP at U              250 mV
  dynamics             100 mV
  max.rate             max. ml/min
  min.volume incr.    min. µl
  stop crit:          drift
  stop drift          20 µl/min
>titration parameters
  titr.direction:     -
  pause 1              0 s
  start V:            OFF
  pause 2              0 s
  extr.time           0 s
  I(pol)              50 µA
  electrode test:     OFF
  temperature         25.0 °C
  time interval       2 s
>stop conditions
  stop V:             abs.
  stop V              99.99 ml
  filling rate        max. ml/min
>statistics
  status:             ON
  mean                n= 5
  res.tab:            original
>preselections
  conditioning:       ON
  display drift:      ON
  drift corr:         OFF
  req.ident:          OFF
  req.smpl size:      value
  limit smpl size:    OFF
  oven:               no
  activate pulse:     OFF
  -----

'fm
795 KFT Titrino          795.0010
date 2001-11-15      time 14:56      0
KFT Ipol              TarTiter
>calculations
Titer=C00/EP1*C01;4;mg/ml
C00=                  1.0
C01=                  156.6
  -----

'de
795 KFT Titrino          795.0010
date 2001-11-15      time 14:56
KFT Ipol              TarTiter
def
>formula
  Titer=C00/EP1*C01
  RS1 text            Titer
  RS1 decimal places  4
  RS1 unit:           mg/ml
  RS1 limit control:  OFF
>silco calculations
  match id:           OFF
>common variables
  C39=MN1
>report
  report COM1:full;
>mean
  MN1=RS1
>temporary variables
  -----
```

The titer is calculated as mean value out of 5 single determinations and stored as common variable C39. Therefore, it can be directly used in subsequent methods.

Electrode:

Double Pt-electrode 6.0338.100 at measuring input "Pol".

Titration agent:

One-component or two-component Karl-Fischer reagent, ready to use.

Solvent:

20 mL Methanol or a specific solvent, conditioned.

Sample:

200–300 mg Disodium tartrate dihydrate (water content 15.66 ±0.05%), stir to complete dissolution.

References:

G. Wieland, Water determination by Karl Fischer Titration, GIT Verlag, Darmstadt, Germany
 HYDRANAL® Practical Course, Water reagents for Karl-Fischer-Titration according to Eugen Scholz, Riedel de Haën, Seelze, Germany
 METROHM Application Bulletin No. 77: Karl Fischer Water Determinations

- Result in mg/mL
- Sample size in g
- Water content of disodium tartrate dihydrate * 10
 If the sample size is given in mg, the factor is 0.1566.

C39 is the common variable for the titer

6.3.4 Blank determination for KFT "Blank_KF"

```
'pa
795 KFT Titrino              795.0010
date 2001-11-15      time 18:01      0
KFT Ipol              Blank_KF
parameters
>control parameters
  EP at U              250 mV
  dynamics             100 mV
  max.rate             max. ml/min
  min.volume incr.    min. µl
  stop crit:          drift
  stop drift          20 µl/min
>titration parameters
  titr.direction:     -
  pause 1             0 s
  start V:            OFF
  pause 2             0 s
  extr.time           0 s
  I(pol)              50 µA
  electrode test:     OFF
  temperature         25.0 °C
  time interval       2 s
>stop conditions
  stop V:             abs.
  stop V              99.99 ml
  filling rate        max. ml/min
>statistics
  status:             ON
  mean                n= 3
  res.tab:            original
>preselections
  conditioning:       ON
  display drift:     ON
  drift corr:        OFF
  req.ident:         OFF
  req.smpl size:     OFF
  limit smpl size:   OFF
  oven:              no
  activate pulse:    OFF
  -----

'fm
795 KFT Titrino              795.0010
date 2001-11-15      time 18:01      0
KFT Ipol              Blank_KF
>calculations
Blank=EP1;4;ml
  -----

'de
795 KFT Titrino              795.0010
date 2001-11-15      time 18:02
KFT Ipol              Blank_KF
def
>formula
  Blank=EP1
  RS1 text            Blank
  RS1 decimal places  4
  RS1 unit:           ml
  RS1 limit control:  OFF
>silco calculations
  match id:          OFF
>common variables
  C38=MN1
>report
  report COM1:full;
>mean
  MN1=RS1
>temporary variables
  -----
```

This method can be generally used for KF blank determinations. For work with a KF oven, you need to enter an extraction time in key <PARAM>, ">titration parameters".

The mean value out of 3 determinations is assigned to the common variable C38.

Electrode:

Double Pt-electrode 6.0338.100 at measuring input "Pol".

Titration agent:

One-component or two-component Karl-Fischer reagent, ready to use.

Solvent:

20 mL Methanol or a specific solvent, conditioned.

Sample:

E.g. 1.000 mL methanol (as used for extraction) or another solvent.

References:

G. Wieland, Water determination by Karl Fischer Titration, GIT Verlag, Darmstadt, Germany
 HYDRANAL® Practical Course, Water reagents for Karl-Fischer-Titration according to Eugen Scholz, Riedel de Haën, Seelze, Germany
 METROHM Application Bulletin No. 77: Karl Fischer Water Determinations

C38 is the common variable for the KF blank value.

6.3.5 KF-titration with blank value subtraction "KF-Blank"

```
'pa
795 KFT Titrino                      795.0010
date 2001-11-15      time 18:04      0
KFT Ipol              KF-Blank
parameters
>control parameters
  EP at U              250 mV
  dynamics             100 mV
  max.rate             max. ml/min
  min.volume incr.    min. µl
  stop crit:          drift
  stop drift          20 µl/min
>titration parameters
  titr.direction:     -
  pause 1             0 s
  start V:            OFF
  pause 2             0 s
  extr.time           0 s
  I(pol)              50 µA
  electrode test:     OFF
  temperature         25.0 °C
  time interval       2 s
>stop conditions
  stop V:             abs.
  stop V              99.99 ml
  filling rate        max. ml/min
>statistics
  status:             ON
  mean                n= 3
  res.tab:            original
>preselections
  conditioning:       ON
  display drift:      ON
  drift corr:         OFF
  req.ident:          OFF
  req.smpl size:      all
  limit smpl size:    OFF
  oven:               no
  activate pulse:     OFF
  -----

'fm
795 KFT Titrino                      795.0010
date 2001-11-15      time 18:04      0
KFT Ipol              KF-Blank
>calculations
Water=(EP1-C38)*C39*C01/C00/C02;2;%
Titer=C39;4;mg/ml
Blank=C38;4;ml
C00=                    1.0
C01=                    0.1
C02=                    1
C38=                    0.0
C39=                    0.0
  -----
```

KF-titration regarding a blank value (e.g. for an extraction solvent), being determined before and stored as common variable C38 (see page 132). For work with a KF oven, you need to enter an extraction time in key <PARAM>, ">titration parameters".

Electrode:

Double Pt-electrode 6.0338.100 at measuring input "Pol".

Titrating agent:

One-component or two-component Karl-Fischer reagent, ready to use.

Solvent:

20 mL Methanol or a specific solvent, conditioned.

Sample:

Sample size depending on expected consumption of KF reagent.

References:

G. Wieland, Water determination by Karl Fischer Titration, GIT Verlag, Darmstadt, Germany
 HYDRANAL® Practical Course, Water reagents for Karl-Fischer-Titration according to Eugen Scholz, Riedel de Haën, Seelze, Germany
 METROHM Application Bulletin No. 77: Karl Fischer Water Determinations

– Result in %

- Sample size in g
- Factor for % (see page 134)
- Divisor (see page 134)
- Blank value in mL
- KF titer

```
'de
795 KFT Titrimo           795.0010
date 2001-11-15   time 18:04
KFT Ipol           KF-Blank
def
>formula
  Water=(EP1-C38)*C39*C01/C00/C02
  RS1 text           Water
  RS1 decimal places 2
  RS1 unit:          %
  RS1 limit control: OFF
  Titer=C39
  RS2 text           Titer
  RS2 decimal places 4
  RS2 unit:          mg/ml
  RS2 limit control: OFF
  Blank=C38
  RS3 text           Blank
  RS3 decimal places 4
  RS3 unit:          ml
  RS3 limit control: OFF
>silco calculations
  match id:         OFF
>common variables
>report
  report COM1:full;
>mean
  MN1=RS1
>temporary variables
  .....
```

Adjust the calculation values C01 and C02 according the desired result unit and your sample size.

Unit RS	Sample size in..	C01	C02
%	g	0.1	1
%	mg	100	1
%	mL	0.1	Density of Sample
ppm	g	1000	1
ppm	mL	1000	Density of Sample
ppm	µL	1000 000	Density of Sample
mg/mL	g	Density of Sample	1
mg/mL	mL	1	1
g/L	g	Density of Sample	1
g/L	mL	1	1
mg	1	1	1
mL	1	1	1000 * Density H ₂ O
mg/pc	pc	1	1

6.3.6 KF-titration without blank value subtraction "KF"

```
'pa
795 KFT Titrino                795.0010
date 2001-11-15    time 18:06    0
KFT Ipol            KF
parameters
>control parameters
  EP at U            250 mV
  dynamics           100 mV
  max.rate           max. ml/min
  min.volume incr.  min. µl
  stop crit:        drift
  stop drift        20 µl/min
>titration parameters
  titr.direction:   -
  pause 1           0 s
  start V:          OFF
  pause 2           0 s
  extr.time         0 s
  I(pol)            50 µA
  electrode test:   OFF
  temperature       25.0 °C
  time interval     2 s
>stop conditions
  stop V:           abs.
  stop V            99.99 ml
  filling rate      max. ml/min
>statistics
  status:           ON
  mean              n= 3
  res.tab:          original
>preselections
  conditioning:     ON
  display drift:    ON
  drift corr:       OFF
  req.ident:        OFF
  req.smpl size:    all
  limit smpl size: OFF
  oven:             no
  activate pulse:   OFF
  -----

'fm
795 KFT Titrino                795.0010
date 2001-11-15    time 18:06    0
KFT Ipol            KF
>calculations
Water=EP1*C39*C01/C00/C02;2;%
Titer=C39;4;mg/ml
C00=          1.0
C01=          0.1
C02=          1
C39=          0.0
  -----
```

KF titration without blank value subtraction.

Electrode:

Double Pt-electrode 6.0338.100 at measuring input "Pol".

Titration agent:

One-component or two-component Karl-Fischer reagent, ready to use.

Solvent:

20 mL Methanol or a specific solvent, conditioned.

Sample:

Sample size depending on expected consumption of KF reagent.

References:

G. Wieland, Water determination by Karl Fischer Titration, GIT Verlag, Darmstadt, Germany
 HYDRANAL® Practical Course, Water reagents for Karl-Fischer-Titration according to Eugen Scholz, Riedel de Haën, Seelze, Germany
 METROHM Application Bulletin No. 77: Karl Fischer Water Determinations

- Result in %

- Sample size in g
- Factor for % (see page 134)
- Divisor (see page 134)
- KF titer

```
'de
795 KFT Titrimo           795.0010
date 2001-11-15      time 18:06
KFT Ipol              KF
def
>formula
  Water=EP1*C39*C01/C00/C02
  RS1 text              Water
  RS1 decimal places    2
  RS1 unit:              %
  RS1 limit control:    OFF
  Titer=C39
  RS2 text              Titer
  RS2 decimal places    4
  RS2 unit:              mg/ml
  RS2 limit control:    OFF
>silco calculations
  match id:              OFF
>common variables
>report
  report COM1:full;
>mean
  MN1=RS1
>temporary variables
  -----
```

6.3.7 KF titrations with various KF reagents

If you work parallel with different KF reagents, you can use different methods for each KF reagent. The titer determination is performed with H₂O or methanol standard as described for the method "H2OTiter". The factor C01 has to be adapted to the standard used (see page 130). For each reagent, the titer is assigned to another common variable which is taken into account in the calculations of the titration method (see table). The titration parameters are suitable both for water determinations using one-component reagents and two-component reagents. The KF titrations without blank value subtraction are executed according to the description for the method "KF" (see page 135). For the blank determination the method "Blank_KF" is used. The mean value of three blank determinations is assigned to the common variable C38. The KF titrations with blank value subtraction are executed according to the description for the method "KF-Blank " (see page 133). Remember that you need to adapt the factors in the formula (see table on page 134).

KF reagents	Methods		Common Variables
One-component- or two-component KF reagent (5 mg/mL H ₂ O) for medium and high amounts of water	Titer determination KF-titration without BV-subtr. KF-titration with BV-subtraction Blank determination	5Titer 5Deter 5Deter-B Blank_KF	Titer = C32 Calculation with C32 Calculation with C32 and C38 Blank = C38
One-component- or two-component KF reagent (2 mg/mL H ₂ O) for small amounts of water	Titer determination KF-titration without BV-subtr. KF-titration with BV-subtraction Blank determination	2Titer 2Deter 2Deter-B Blank_KF	Titer = C33 Calculation with C33 Calculation with C33 and C38 Blank = C38
One-component- or two-component KF reagent (1 mg/mL H ₂ O) for micro-determination of water	Titer determination KF-titration without BV-subtr. KF-titration with BV-subtraction Blank determination	1Titer 1Deter 1Deter-B Blank_KF	Titer = C34 Calculation with C34 Calculation with C34 and C38 Blank = C38
Special KF reagent for water determination in solutions that contain aldehydes and/or ketones	Titer determination KF-titration without BV-subtr. KF-titration with BV-subtraction Blank determination	KetTiter KetDeter KetDet-B Blank_KF	Titer = C35 Calculation with C35 Calculation with C35 and C38 Blank = C38

BV = Blank value

If you use various titration reagents, generally make sure that the values of the titers for the various titration reagents are assigned to different common variables which are taken into account in the calculations of the corresponding titration methods.

6.3.8 Determination of the bromine number "BrNumber"

```
'pa
795 KFT Titrino          795.0010
date 2001-11-15      time 14:52      0
KFT Ipol          BrNumber
parameters
>control parameters
  EP at U          500 mV
  dynamics         500 mV
  max.rate        5 ml/min
  min.volume incr. min. µl
  stop crit:      time
  t(delay)        30 s
>titration parameters
  titr.direction: -
  pause 1         0 s
  start V:        OFF
  pause 2         0 s
  extr.time       0 s
  I(pol)          10 µA
  electrode test: OFF
  temperature     25.0 °C
  time interval   2 s
>stop conditions
  stop V:         abs.
  stop V          99.99 ml
  filling rate    max. ml/min
>statistics
  status:         ON
  mean            n= 3
  res.tab:        original
>preselections
  conditioning:   OFF
  req.ident:      OFF
  req.smpl size:  value
  limit smpl size: OFF
  activate pulse: OFF
  -----

'fm
795 KFT Titrino          795.0010
date 2001-11-15      time 14:52      0
KFT Ipol          BrNumber
>calculations
BrNumber=(EP1-C01)*C02*C03*C04/C00;0;
C00=          1.0
C01=          0.0
C02=          0.5
C03=          7.99
C04=          100
  -----

'de
795 KFT Titrino          795.0010
date 2001-11-15      time 14:52
KFT Ipol          BrNumber
def
>formula
  BrNumber=(EP1-C01)*C02*C03*C04/C00
  RS1 text          BrNumber
  RS1 decimal places 0
  RS1 unit:
  RS1 limit control: OFF
>silco calculations
  match id:         OFF
>common variables
>report
  report COM1:full;
>mean
  MN1=RS1
>temporary variables
  -----
```

Determination of the bromine number in petroleum hydrocarbons according to ASTM D 1159-84.

The bromine number is defined as the quantity of bromine in mg which reacts with 100 g of the sample.

Electrode:

Double Pt-electrode 6.0338.100 at measuring input "Pol".

Titration agent:

Bromide/bromate-solution,
 $c(\text{BrO}_3^-/\text{Br}^-) = 0.5 \text{ mol/L}$
 Dissolve 51.0 g KBr and 13.92 g KBrO_3 each in distilled water and add up to 1 L.

Solvent:

714 mL glacial acetic acid,
 134 mL 1,1,1-trichloroethane,
 134 mL methanol,
 18 mL $w(\text{H}_2\text{SO}_4) = 0.2$ (20%)

Sample:

Pipet 25 mL 1,1,1-Trichloroethane into a 50-mL volumetric flask and add the sample (see table below). The weight of the sample is obtained by difference between the weight of the flask before and after addition of the sample. Fill the flask to the mark with 1,1,1-trichloroethane and mix well. Add 5 mL of the sample solution to 110 mL solvent in the titration vessel and mix. The blank sample is titrated in the same way.

- Result in % (g bromine/100 g sample)
- Sample size in g
- Consumption of Blank sample in mL
- Normality of the titrating agent in mol/L
- Molecular mass of Br (79.9 g/mol) * 0.1 (Conversion to % in weight and L)
- C04 = Dilution factor (Has to be calculated according to the sample preparation, for the method described above, the factor is 10.)

Bromine no. (% w/w)	Sample size (g)
0...10	20...16
10...20	10...8
20...50	5...4
50...100	2...1.5
100...200	1.0...0.5

References:

ASTM D 1159-84
 Metrohm Application Bulletin No. 177

6.4 Titrino validation

Checking and maintenance of the Titrino is carried out in 3 steps:

1. Testing the electronic components when the Titrino is switched on.
2. Wet-chemistry validation of the whole analysis setup
3. Maintenance and adjustment of the Titrino by Metrohm service.

6.4.1 Electronic tests

When the Titrino is switched on electronic tests are carried out. During this period **system tests** appears in the display.

The tests are documented in the system test report, which can be printed out when the Titrino is switched on (see page 10):

```

'di
795 KFT Titrino      01103      795.0010
date 2001-11-15    time 07:24
RAM test            OK
real time clock     OK
timer               OK
A/D converter       OK
LCD display         OK
COMPorts           OK
EPROM test         OK
=====
    
```

Contact Metrohm service if one of these tests is "not OK".

If the "real time clock" test is not ok, you can try to set date and time again. If the test is OK afterwards you should check whether your stored methods have remained unchanged.

6.4.2 Wet tests

GLP (Good Laboratory Practice) requires the periodic validation of the analytical instruments. The reproducibility and accuracy of the instruments are checked.

An annual repetition of the procedure appears to be sensible. Depending on the requirements a more frequent check may be indicated, e.g. every 3 or 6 months.

Guidelines for the testing regulations (SOP, Standard Operating Procedure) are given in Metrohm Application Bulletin

No. 255: Validation of Metrohm KF Titrators and KF Oven according to GLP/ISO 9001.

The validation interval can be checked by the Titrino (set under <CONFIG>, monitoring). If the interval has elapsed the Titrino displays the message **validate instrument**.

6.4.3 Maintenance and adjustment of the Titrino

The Titrino should be serviced and adjusted by Metrohm service at regular intervals.

The Titrino can check the date of the next service with the help of the monitoring function "Service" under <CONFIG>, monitoring. If this date has been passed then the Titrino will display the message **service is due**.

6.5 Warranty and conformity

6.5.1 Warranty

The warranty regarding our products is limited to rectification free of charge in our workshops of defects that can be proved to be due to material, design or manufacturing faults which appear within 12 months from the day of delivery. Transport costs are chargeable to the purchaser.

For day and night operation, the warranty is valid for 6 months.

Glass breakage in the case of electrodes or other glass parts is not covered by the warranty. Checks which are not a result of material or manufacturing faults are also charged during the warranty period. For parts of outside manufacture insofar as these constitute an appreciable part of our instrument, the warranty stipulations of the manufacturer in question apply.



With regard to the guarantee of accuracy, the technical specifications in the Instructions for Use are authoritative.

Concerning defects in material, construction or design as well as the absence of guaranteed features, the purchaser has no rights or claims except those mentioned above.

If damage of the packaging is evident on receipt of a consignment or if the goods show signs of transport damage after unpacking, the carrier must be informed immediately and a written damage report demanded. Lack of an official damage report releases METROHM from any liability to pay compensation.

If any instruments and parts have to be returned, the original packaging should be used if at all possible. This applies above all to instruments, electrodes, buret cylinders and PTFE pistons. Before embedment in wood shavings or similar material, the parts must be packed in a dustproof package (for instruments, use of a plastic bag is imperative). If open assemblies are enclosed in the scope of delivery that are sensitive to electromagnetic voltages (e.g. data interfaces etc.) these must be returned in the associated original protective packaging (e.g. conductive protective bag). (Exception: assemblies with built-in voltage source belong in a non-conductive protective packaging). For damage which arises as a result of non-compliance with these instructions, no warranty responsibility whatsoever will be accepted by METROHM.

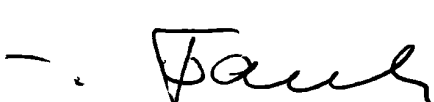
6.5.2 EU Declaration of conformity

 <p>EU Declaration of Conformity</p>							
<p>The company Metrohm AG, Herisau, Switzerland, certifies herewith, that the following instrument:</p> <p style="text-align: center;">795 KFT Titrino</p> <p>meets the CE mark requirements of EU Directives 89/336/EWG and 73/23/EWG.</p>							
<p>Source of specifications:</p> <table style="width: 100%; border: none;"> <tr> <td style="width: 20%;">EN 50081</td> <td>Electromagnetic compatibility — Generic emission standard</td> </tr> <tr> <td>EN 50082</td> <td>Electromagnetic compatibility — Generic immunity standard</td> </tr> <tr> <td>EN 61010</td> <td>Safety requirements for electrical equipment for measurement, control and laboratory use</td> </tr> </table>		EN 50081	Electromagnetic compatibility — Generic emission standard	EN 50082	Electromagnetic compatibility — Generic immunity standard	EN 61010	Safety requirements for electrical equipment for measurement, control and laboratory use
EN 50081	Electromagnetic compatibility — Generic emission standard						
EN 50082	Electromagnetic compatibility — Generic immunity standard						
EN 61010	Safety requirements for electrical equipment for measurement, control and laboratory use						
<p>Description of apparatus:</p> <p>Titration for fast and precise water determination with LCD graphical display. Titration sequences can be programmed and methods stored in the internal memory.</p>							
<p>Herisau, October 30, 2001</p> <div style="display: flex; justify-content: space-around; align-items: center; margin-top: 20px;"> <div style="text-align: center;">  <p>Dr. J. Frank Development Manager</p> </div> <div style="text-align: center;">  <p>Ch. Buchmann Production and Quality Assurance Manager</p> </div> </div>							

6.5.3 Certificate of Conformity and System Validation

Certificate of Conformity and System Validation

This is to certify the conformity to the standard specifications for electrical appliances and accessories, as well as to the standard specifications for security and to system validation issued by the manufacturing company.

Name of commodity:	795 KFT Titrimo
System software:	Stored in ROMs
Name of manufacturer:	Metrohm Ltd., Herisau, Switzerland

This Metrohm instrument has been built and has undergone final type testing according to the standards:

Electromagnetic compatibility:
IEC61326-1

Electromagnetic compatibility: Emission
EN50081-1, EN50081-2, EN55022 (class B), IEC61000-3-2

Electromagnetic compatibility: Immunity
EN50082-1, IEC61000-6-2, Namur, IEC61000-4-2, IEC61000-4-3, ENV50204, IEC61000-4-4, IEC61000-4-5, IEC61000-4-6, IEC61000-4-11

Safety specifications
IEC61010-1, EN61010-1, UL3101-1

It has also been certified by the Swiss Electrotechnical Association (SEV), which is member of the International Certification Body (CB/IEC).

The technical specifications are documented in the instruction manual.

The system software, stored in Read Only Memories (ROMs) has been validated in connection with standard operating procedures in respect to functionality and performance. The features of the system software are documented in the instruction manual.

Metrohm Ltd. is holder of the SQS-certificate of the quality system ISO 9001 for quality assurance in design/development, production, installation and servicing.

Herisau, October 30, 2001



Dr. J. Frank

Ch. Buchmann

Development Manager

Production and
Quality Assurance Manager

6.6 Scope of delivery and ordering designations

795 KFT Titrino**2.795.0010**

inclusive the following accessories:

1 Keypad for KFT Titrino 795	6.2130.070
1 Key for Exchange Units	6.2739.010
1 Double Pt-electrode with plug-in head, without cable.....	6.0338.100
1 Electrode cable with plug F 1M.....	6.2104.020
1 Titration vessel lid	6.1414.030
1 Titration vessel 20 mL.....	6.1415.220
1 Titration vessel 50 mL.....	6.1415.250
1 Set of O-rings for the Titration vessel lid.....	6.1244.040
1 Drying tube	6.1403.040
1 Molecular sieve 250 g.....	6.2811.000
2 Screw nipple for KF	6.2730.010
1 Stopper with septum, diameter 18 mm	6.2730.020
3 Stopper with nipple and O-ring	6.2730.030
2 Septum (5 p.).....	6.1448.010
1 Glass weighing spoon.....	6.2412.000
2 Teflon stirring bar, length 16 mm.....	6.1903.020
2 Teflon stirring bar, length 25 mm.....	6.1903.030
1 Cover	6.2723.130
1 Mains cable with cable socket, type CEE(22), V	
Cable plug to customer's specifications	
type SEV 12 (Switzerland...)	6.2122.020
type CEE(7), VII (Germany...)	6.2122.040
type NEMA/ASA (USA...)	6.2122.070
1 Vesuv 3.0 light, PC program for data acquisition and method backup	
for 2 devices	6.6008.500
1 Instructions for Use for 795 KFT Titrino	8.795.1003
1 Quick References for 795 KFT Titrino.....	8.795.1013
1 Short Operating Guide for 795 KFT Titrino	8.795.1023

Options

Accessories to separate order and on payment of extra charge:

Burets

Auxiliary burets

765 Dosimat	2.765.0010
776 Dosimat	2.776.0010
Cable 795 KFT Titrino (activate pulse, line L6) — 765 or 776 Dosimat	6.2139.000

Exchange Units

V = 1 mL	6.3026.110
V = 5 mL	6.3026.150
V = 10 mL	6.3026.210
V = 20 mL	6.3026.220
V = 50 mL	6.3026.250

Stirrers and Titrating Stands

703 Ti Stand for KF titrations	2.703.0010
728 Magnetic stirrer	2.728.0040
727 Ti Stand for rinsing and addition of fresh solvent	2.727.0010
802 Rod Stirrer	2.802.0010
727 Ti Stand with built-in magnetic stirrer	2.727.0100

Titration equipment

Equipment for KF titrations	6.5609.000
Titration vessel, volumes	
1... 50 mL	6.1415.110
5... 70 mL	6.1415.150
10... 90 mL, order 6.2036.000 holding ring separately	6.1415.210
20... 90 mL	6.1415.220
50... 150 mL	6.1415.250
70... 200 mL	6.1415.310
Titration vessel with thermostatic jacket, volumes	
1... 50 mL	6.1418.110
5... 70 mL	6.1418.150
20... 90 mL	6.1418.220
50... 150 mL	6.1418.250
Titration vessel lid (5 openings)	6.1414.010
Magnetic stirring bars, length	
12 mm	6.1903.010
16 mm	6.1903.020
25 mm	6.1903.030
Electrode holder	6.2021.020

Electrodes and accessories

Double Pt-electrode with plug-in head, without cable	6.0338.100
Electrode cable, 1m	6.2104.020

Printers

Printer Custom DP40-S4N.....	2.140.0200
Cable Titrino – Custom DP40-S4N	6.2134.110
Cable Titrino – Seiko DPU-414	6.2134.110
Cable Titrino – EPSON LX300+ (9/25 pins)	6.2134.050
Cable Titrino – HP Desk Jet (serial interface) (9/25 pins).....	6.2134.050
Cable Titrino – HP Desk/Laser Jet (parallel IF).....	2.145.0330
Adapter for connection of printer/balance at the same COM	6.2125.010+6.2125.030

Balance

For Mettler cables you need an adapter 9/25 pins	6.2125.010
Cable Sartorius – balances MP8, MC1 (9/25 pins)	6.2134.060
Cable Shimadzu – balances BX, BW	6.2125.080+6.2125.010
Ohaus Voyager, Explorer, Analytical Plus balances.....	cable from Ohaus
Mettler AB, AG balances (interface LC-RS25).....	cable with balance
Mettler AT balance	6.2146.020+6.2125.010
Mettler AM, PM balance	6.2146.020+6.2125.010+accessories from Mettler
Mettler balances with interface 016.....	cable from Mettler
Mettler balances with interface 011 or 012.....	6.2125.020+6.2125.010
Mettler PG, AB-S.....	6.2134.110
Mettler AX, MX, UMX	6.2134.120
AND balances (with RS232 interface OP-03)	6.2125.020+6.2125.010
Precisa balances	6.2125.080+6.2125.010
Adapter for connection of printer/balance at the same COM	6.2125.010+6.2125.030

Connection of PC keyboard and/or barcode reader

Remote Box.....	6.2148.000
-----------------	------------

Connection of 768 KF Oven

KF Oven.....	2.768.0010
Cable 795 KFT Titrino — 768 KF Oven, control	6.2141.010
Cable 795 KFT Titrino — 768 KF Oven, data	6.2125.110

PC connection

Cable 795 KFT Titrino – PC (9 pins female / 9 pins female).....	6.2134.040
Cable 795 KFT Titrino – PC (9 pins female / 25 pins female).....	6.2125.110
RS232 C extension cable (25 pins male / 25 pins female).....	6.2125.020
RS232 C extension cable (9 pins male / 9 pins female).....	6.2134.110
Vesuv 3.0, PC program for data acquisition and method backup for up to 64 devices.....	6.6008.200

Sample Changer

730 Sample Changer, 1 working station, 1 pump and 2 stirrer connections.....	2.730.0010
730 Sample Changer, 1 working station, 2 pumps and 2 stirrer connections.....	2.730.0020
730 Sample Changer, 1 working station, no pumps and 2 stirrer connections...	2.730.0030
730 Sample Changer, 2 working stations, 2 pumps and 4 stirrer connections...	2.730.0110
730 Sample Changer, 2 working stations, 4 pumps and 4 stirrer connections...	2.730.0120
730 Sample Changer, 2 working stations, no pumps and 4 stirrer connections.	2.730.0130
760 Sample Changer, 1 working station, no pumps and 2 stirrer connections...	2.760.0020
for KFT applications	
774 Oven Sample Processor	2.774.0010
Cable 795 KFT Titrino — 730, 760, 774 Sample Changer	6.2141.020
Cable 2x 795 KFT Titrino — 730, 760 Sample Changer	6.2141.030
Cable Titrino — 730, 760 Sample Changer+665, 725, 765, 776 Dosimat	6.2141.040
Cable Titrino — 730, 760 Sample Changer+ 2x 665, 725, 765, 776 Dosimat ...	6.2141.050
Cable 795 KFT Titrino — Control Unit 664 for Sample Changer 673/674	3.980.3560

Index

Keys are marked with < >, **display texts** are in bold characters, and pages concerning the green part are *printed in italic*.

A

<ABC>	8
Accessories	143ff
activate pulse:	19
Analog potentiometer	3
Automatic reports	31
auto start:	11
auxiliaries	11

B

balance:	10
Balance connection	114
barcode:	11
Barcode reader	11, 118
baud rate:	12
bytes missing	97

C

Cables	145ff
Calculations	25
Certificates	141
CE	141
<C-FMLA>	6, 27
Characters input	8
check	97
<CLEAR>	6
common variables	12, 30
Computer connection	118
COM X	
characteristics	90ff
configuration	12
pin assignment	93
conditioning:	18
<CONFIG>	6, 9
Configuration	9
Conformity	140
Connection	
balance	114
barcode reader	118
computer	118
electrode	122
Karl Fischer oven	115
oven sample processor	117
PC keyboard	119
printer	113
remote box	118
sample changer	116
stirrer	112
Ti Stand	112

Connection cables	145ff
Contrast of display	3
control parameters	15
Control parameters KFT	21
Cursor keys	6
curve	13
<CURVE>	33
Curve	
changing output	15
display	33
examples	32
printing	31
cycle lines:	40

D

data bit:	12
Data	
input	7, 8
output	31
reproduction	32
transfer (RS232)	45ff
date	11
Decimal places	26
<DEF>	6, 25ff
delete all:	40
delete all silo lines	40
delete line n	39
delete n	28
Delete	
common variables	30
formulas	25
methods	36
statistic values	28
text	8
user name	34
delete silo lines	39
dev.label	11
Diagnosis	100ff
Diagnosis report	139
dialog:	11
Display, contrast	3
display drift:	18
division by zero	97
<DOS>	3, 44
Dosing	3, 44
dos.rate	17
drift corr:	18
drift value	18
dynamics	15

E

edit silo lines	39
electrode test:	17
<ENTER>	6
Entry of	
data	7
text	8
EP at	15
Error messages	49ff, 97ff
error XX	97
Exchange Unit	144
extr.time	17

F

Fabrication number	5
factor	17, 18
Filling rate	
after determination	18
after manual dosing	3
formula	25

G

General rules for RS232	45ff
GLP	139
Graphics	
changing output	13
display	33
examples	32
printing	31

H

handshake:	12
Handshake	90
Hardware handshake	93

I

id#1 or C21	37, 39
Identification	37, 39
request	18
Initialize RAM	110
Input of	
values	7
text	8
Inquiries	7
I/O lines	125
I(pol)	17
ISO	142

K

Karl Fischer oven	19, 115
Karl Fischer titration	15ff
keyboard:	10
Keypcode	102
Keypad	6

Keys	6
<ABC>	8
<C-FMLA>	27
<CLEAR>	6
<CONFIG>	9
<CURVE>	33
<DEF>	25ff
<DOS>	3
<ENTER>	6
<MEAS/HOLD>	6
<MODE>	14
<PARAM>	15ff
<PRINT>	32, 33
<QUIT>	6
<REPORTS>	32
<SILO>	38
<SMPL DATA>	37ff
<START>	6
<STATISTICS>	3, 29
<STOP>	6
<USER>	34
<USER METH>	35
KFT	15ff

L

Language	11
LED	3, 29
Limit control	
result	26
sample size	19
limit smpl size:	19
Lock functions	12
low lim.	19

M

Mains	5, 112
Malfunctions	49ff, 97ff, 100ff
man.reports to COM:	10
Manual operation	6ff
manual stop	98
match id:	42
max.rate	16
mean n	28
Mean values	
calculation	28
delete results	28
report	42
silo	43
<MEAS/HOLD>	6
meas.pt list overflow	98
measured quantity:	14
Measuring point list printing	31
Method	35, 39
method name:	35
min.volume incr.	16
missing EP	98

<MODE>	14	output.....	31ff
Mode KFT	15	printing	31
monitoring	9	reproduction	32
		selection.....	31
N		<REPORTS>	32
name:	34	req.ident:	18
next service:	9	req.smpl size:	19
no...	98	res.tab:	28
not valid	98	Result	
		calculation.....	25
O		delete	28
Object tree	52ff	display.....	11
Ordering designations.....	143	limit control.....	26
Outputs	125ff	report.....	31
Oven	19, 115	store	40, 41
Overview	2	text	26
		result display:	11
P		RS1 decimal places	26
Parameters KFT.....	15	RS1 L13 output:	26
<PARAM>	6, 15ff	RS1 limit control:	26
parity:	12	RS1 low lim.	26
pause (X)	16, 17	result out of limits	98
peripheral units	10	RS1 text	26
Pin assignment		RS1 unit:	26
"Remote" socket.....	125	RS1 up lim.	26
RS232	93	RS232 settings COMX	12
Power connection.....	5, 112	RS232 interface	
preselections	18	characteristics.....	90ff
<PRINT>	6, 33	configuration	12
Printing.....	31ff	pin assignment	93
Printer		run number	11
connection	113		
problems	95	S	
selection.....	10	Sample addition	23
Problems		Sample changer.....	116
KF titrations	24	Sample data.....	37ff
printer	95	Sample identification.....	37
program	11	inquiry	18
		Sample size.....	37–39
Q		limit control.....	19
<QUIT>	6	sample size out	98
		save lines:	40
R		Scope of delivery	143
RAM, initialize	110	Selection of	
recall method	35	balance	10
remote box:	10	printer.....	10
Remote control		send to COMX:	10
via "Remote" lines.....	125	Sequence KFT	20
via RS232	45ff	Serial number	5
Remote control commands		service:	10
detailed description	67ff	service is due	98
overview	52	Setting up	112ff
report COMX:	31	<SILO>	6, 38
		silو calculations	41, 42
Report		silو empty	98
		silو full	98

silos lines	39	titr.direction:	16
Silo reports	31, 43	transmission error	99
<SMPL DATA>	6, 37ff	Tree	52ff
smpl size	37, 39	Trigger	47
smpl unit:	37, 39	U	
Software handshake	90	Unit	
Special messages	97	result	26
<START>	6	sample	37, 39
start delay	11	up lim.	19
start V	17	U(pol)	17
Start volume	17	<USER>	34
<STATISTICS>	6, 28	<USER METH>	35
statistics	28	User methods	35, 129
Statistics calculations	28	User name	34
Statistics values		delete	34
delete results	28	V	
report	31	validate instrument	99
silo	42	Validation	139
Stirrer connection	112	validation:	9
stirrer control:	10	Values input	7, 8
<STOP>	6	Variables CXX	26
stop bit:	12	W	
stop conditions	18	Warranty	140
stop crit:	16	wrong sample	99
Stop criterion	16		
stop drift	16		
stop V reached	99		
stop time	16		
stop V	18		
Store			
methods	35		
results	41, 42		
Survey	2		
system error XX	99		
system test report:	10		
T			
Technical specifications	123		
t(delay)	16		
temperature	17		
Text input	8		
time	11		
time counter	9		
time interval	9		
time-out PC keyboard	99		
Titration			
problems	24		
vessel	122		
Titration curve			
changing output	13		
display	33		
examples	32		
printing	31		
Titration modes	14		
Titration parameters KFT	15		
Titration sequence KFT	20		