

OMNIS Rod Stirrer



2.1006.00X0

Product manual

8.1006.8002EN / 2021-07-23



Metrohm AG
Ionenstrasse
CH-9100 Herisau
Switzerland
+41 71 353 85 85
info@metrohm.com
www.metrohm.com

OMNIS Rod Stirrer

2.1006.00X0

Product manual

8.1006.8002EN /
2021-07-23

Technical Communication
Metrohm AG
CH-9100 Herisau

This documentation is protected by copyright. All rights reserved.

This documentation has been prepared with great care. However, errors can never be entirely ruled out. Please send comments regarding possible errors to the address above.

Disclaimer

Deficiencies arising from circumstances that are not the responsibility of Metrohm, such as improper storage or improper use, etc., are expressly excluded from the warranty. Unauthorized modifications to the product (e.g. conversions or attachments) exclude any liability on the part of the manufacturer for resulting damage and its consequences. Instructions and notes in the Metrohm product documentation must be strictly followed. Otherwise, Metrohm's liability is excluded.

Table of contents

1	Overview	1
1.1	OMNIS Rod Stirrer – Product description	1
1.2	OMNIS Rod Stirrer – Product versions	1
1.3	Symbols and conventions	2
1.4	Further information	3
1.5	Accessories	3
2	Safety	4
2.1	Intended use	4
2.2	Responsibility of the operator	4
2.3	Requirements for operating personnel	5
2.4	Safety instructions	5
2.4.1	Danger from electrical potential	5
2.4.2	Danger from biological and chemical hazardous substances	5
2.4.3	Danger from highly flammable substances	6
2.4.4	Danger from leaking liquids	6
2.4.5	Danger during transport of the product	7
2.4.6	Dangers from hot surfaces and liquids	7
2.4.7	Dangers due to automated motion sequences	7
2.5	Design of warning messages	7
2.6	Meaning of warning signs	8
3	Functional description	10
3.1	OMNIS Rod Stirrer – Overview	10
3.2	OMNIS Rod Stirrer – Indicators	10
3.3	System – Signals	11
4	Delivery and packaging	12
4.1	Delivery	12
4.2	Packaging	12
5	Installation	13
5.1	OMNIS Rod Stirrer – Mounting to the electrode holder	13
5.2	OMNIS Rod Stirrer – Adjusting the stirring propeller height	15

1 Overview

1.1 OMNIS Rod Stirrer – Product description

The OMNIS Rod Stirrer is a rod stirrer with which you can stir liquids at various speed levels and in different directions (clockwise/counterclockwise).

Various stirring propellers are available for the OMNIS Rod Stirrer, depending on the sample beaker size and the solution quantity.

1.2 OMNIS Rod Stirrer – Product versions

The product is available in the following versions:

Table 1 Product versions

Article number	Designation	Version feature	Version feature
2.1006.0010	OMNIS Rod Stirrer Sample Robot	Cable length: 2.5 m	Rod stirrer for automation
2.1006.0020	OMNIS Rod Stirrer Titration	Cable length: 1.1 m	Rod stirrer for titration

A variety of stirring propellers are available for the OMNIS Rod Stirrer:

Table 2 Overview stirring propellers

Article number	Designation	Version feature		
		Diameter	Material	Area of application
6.01900.010	Stirring propeller	30 mm	ETFE	Beaker 200–600 mL Sample beaker, glass, 250 mL (6.01400.000) Sample beaker, PP, 250 mL (6.01400.100)
6.01900.020	Stirring propeller	13 mm	ETFE	Sample beaker, glass, 75 mL (6.01402.000)
6.01900.030	Stirring propeller	20 mm	ETFE	Beaker 50–250 mL Sample beaker, PP, 120 mL (6.1459.300) Sample beaker, glass, 75 mL (6.01402.000)



The article number and serial number for identifying the product can be found on the type plate:

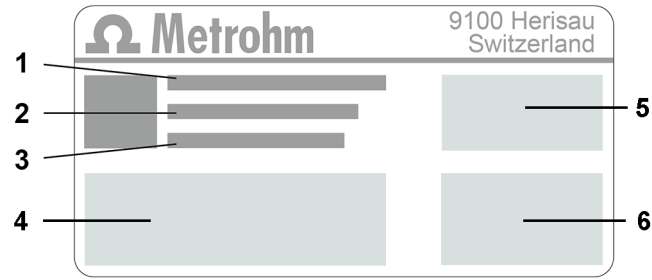

1	(01) = Article number in accordance with GS1 standard	2	(21) = Serial number
3	(240) = Metrohm article number	4	Certification
5	Certification	6	Technical specifications

1.3 Symbols and conventions

The following formatting may appear in the documentation:

(5-12)	Cross-reference to figure legend The first number refers to the figure number. The second number refers to the product part in the figure.
1	Instruction step Numbers indicate the order of the instructions steps.
Method	Names of parameters, menu items, tabs and dialog windows
File ► New	Menu path
[Continue]	Button or key

1.4 Further information

The Metrohm Knowledge Base <https://guide.metrohm.com> always provides the current version of this document. Further instructions, leaflets, release notes etc. may be available, depending on the product. You can directly access the required information or the associated PDF document using the full-text search function and filters.

1.5 Accessories

Up-to-date information on the scope of delivery and on optional accessories can be found on the Metrohm website. Download this information as follows:

Downloading the accessories list

- 1 Go to <https://www.metrohm.com>.
 - 2 Enter the article number of the product (e.g. **2.1001.0010**) into the search field.
The search result is displayed.
 - 3 Click on the product.
Detailed information regarding the product is shown on various tabs.
 - 4 On the **Included parts** tab, click the link to download the PDF.
The PDF file with the accessories data is loaded.
-  Metrohm recommends downloading the accessories list from the Internet and keeping it for reference purposes.

2.3 Requirements for operating personnel

Only qualified personnel may operate the product. Qualified personnel are persons who meet the following requirements:

- Basic regulations on occupational safety and accident prevention for chemical laboratories are known and complied with.
- Knowledge of handling hazardous chemicals is present. Personnel have the ability to recognize and avoid potential dangers.
- Knowledge regarding the application of fire prevention measures for laboratories is available.
- Safety-relevant information is communicated and understood. The personnel can operate the product safely.
- The user documentation has been read and understood. The personnel operate the product according to the instructions in the user documentation.

2.4 Safety instructions

2.4.1 Danger from electrical potential

Contact with electrical potential can cause serious injuries or death. To avoid danger from electrical potential, observe the following:

- Operate the product only if it is in perfect condition. The housing must also be intact.
- Only use the product with the covers fitted. If covers are damaged or missing, disconnect the product from the energy supply and contact the regional Metrohm service representative.
- Protect live components (e.g. power supply unit, power cord, connection sockets) against moisture.
- Always have maintenance work and repairs on electrical components carried out by a regional Metrohm service representative.
- Disconnect the product from the energy supply immediately if at least one of the following cases occurs:
 - The housing is damaged or open.
 - Live parts are damaged.
 - Moisture penetrates.

2.4.2 Danger from biological and chemical hazardous substances

Contact with biological hazardous substances may cause poisoning from toxins or infections from microorganisms. Contact with aggressive chemical substances may cause poisoning or chemical burns. To avoid danger from biological or chemical hazardous substances, observe the following:



- Label the product according to regulations if it is used for substances that have a potential for chemical hazards and are generally subject to the Hazardous Substances Ordinance.
- Wear personal protective equipment (e.g. protective glasses, gloves).
- Use exhaust equipment when working with vaporizing hazardous substances.
- Dispose of hazardous substances in accordance with regulations.
- Clean and disinfect contaminated surfaces.
- Only use detergents that do not cause any unwanted side reactions with the materials to be cleaned.
- Dispose of chemically contaminated materials (e.g. cleaning material) in accordance with regulations.
- Proceed as follows in case of a return shipment to Metrohm AG or a regional Metrohm representative:
 - Decontaminate the product or product component.
 - Remove the labeling for hazardous substances.
 - Create a declaration of decontamination and enclose it with the product.

2.4.3 Danger from highly flammable substances

Using highly flammable substances or gases may cause fires or explosions. To avoid danger from highly flammable substances, observe the following:

- Avoid ignition sources.
- Use protective grounding.
- Use exhaust equipment.

2.4.4 Danger from leaking liquids

Leaking liquids may cause injuries and may damage the product. To avoid danger from leaking liquids, observe the following:

- Check the product and its accessories for leakages and loose connections.
- Replace leaking parts and connecting elements without delay.
- Tighten loose connecting elements.
- Do not loosen tubing connections under pressure.
- Do not remove aspiration tubing under pressure.
- Carefully pull the ends of the tubing out of the containers.
- Carefully let liquids from tubing drain into suitable containers.
- Insert the buret tips completely into the containers.
- Remove and dispose of leaked liquids in accordance with regulations.
- If you suspect that liquid has penetrated the instrument, disconnect the instrument from the energy supply. Then have the instrument checked by a regional Metrohm service representative.

2.4.5 Danger during transport of the product

Chemical or biological substances may be spilled during the transport of the product. Parts of the product may fall down or may be damaged. There is a risk of injury from chemical or biological substances and pieces of broken glass. To ensure safe transport, observe the following:

- Remove loose parts (e.g. sample racks, sample vessels, bottles) before transport.
- Remove liquids.
- Lift and transport the product with both hands on the base plate.
- Lift and transport heavy products only according to instructions.

2.4.6 Dangers from hot surfaces and liquids

Contact with hot surfaces or hot liquids may cause burns. To avoid the risk of injury, observe the following:

- Install and use the protective devices enclosed with the product.
- Allow hot surfaces to cool down before working on the product.
- Wear heat-resistant protective gloves.
- Clean up spilled liquids and solids immediately.

2.4.7 Dangers due to automated motion sequences

Product parts that move automatically (e.g. robot arm) can cause injuries due to crushing or clamping. To avoid the risk of injury, observe the following:

- Do not reach into the working area of the products during the work process.
- Install and use the protective devices enclosed with the product during the work process.
- Do not bypass the installed protective devices.

2.5 Design of warning messages

There are 4 hazard levels for warning messages. The following signal words are used for classifying the hazard levels in warning messages:

- **DANGER** indicates a hazardous situation which, if not avoided, will result in serious injury or death.
- **WARNING** indicates a hazardous situation which, if not avoided, could result in serious injury or death.
- **CAUTION** indicates a hazardous situation which, if not avoided, could result in minor or moderate injury.
- **NOTICE** indicates a hazardous situation which, if not avoided, could result in property damage.



Warning messages differ in design (color and warning sign) depending on the hazard level:



DANGER

Type and source of danger

Consequences when not observing the notice: An irreversible injury that may result in death is very probable.

- Measures to avoid the danger



WARNING

Type or source of danger

Consequences when not observing the notice: A serious injury that may result in death is probable.

- Measures to avoid the danger



CAUTION

Type or source of danger

Consequences when not observing the notice: A minor to moderate injury is probable.





- Measures to avoid the danger

2.6 Meaning of warning signs

This documentation uses the following warning signs:

Table 3 Warning sign according to ISO 7010

Warning sign	Meaning
	General warning sign
	Warning of electrical voltage
	Warning of hand injuries
	Warning of sharp object
	Warning of hot surface
	Warning of biological hazard

Warning sign	Meaning
	Warning of toxic materials
	Warning of flammable materials
	Warning of corrosive substances
	Warning of optical radiation
	Warning of laser beams

Depending on the intended use of the product, the corresponding warning stickers must be placed on the product.



3 Functional description

3.1 OMNIS Rod Stirrer – Overview

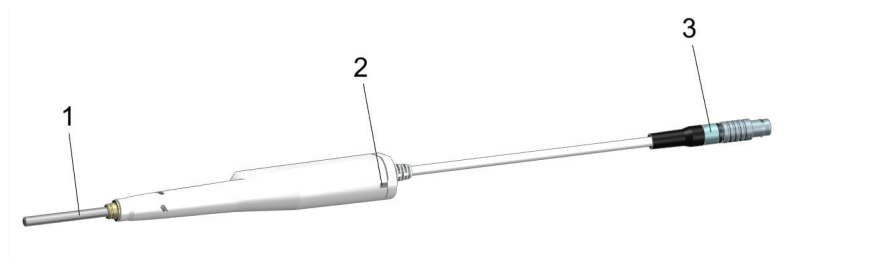

Figure 1 Rod stirrer

- | | |
|---|--|
| <p>1 Metal rod
For fastening the stirring propeller.</p> | <p>2 Status display
LED. Multi-colored.</p> |
| <hr/> <p>3 Cable with plug
For connecting to a control instrument.</p> | |

3.2 OMNIS Rod Stirrer – Indicators

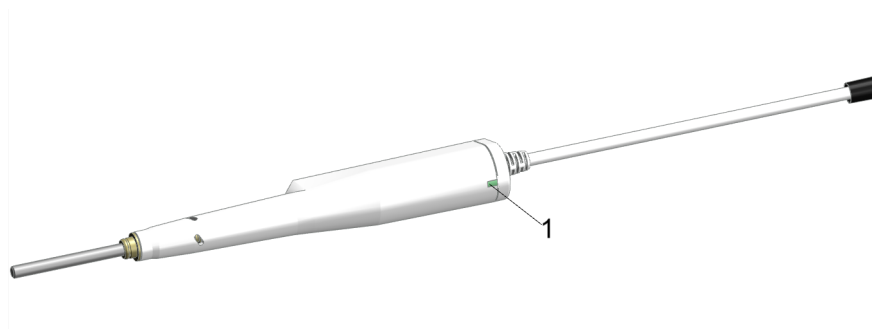

Figure 2 OMNIS Rod Stirrer – Indicators

- 1 Status display**
Multi-colored







The status of the instrument is displayed with the status display (2-1) (see "System – Signals", chapter 3.3, page 11).

See also

System – Signals (chapter 3.3, page 11)

3.3 System – Signals

System components with status indicators show their operating status with colors and/or flashing patterns. The meaning of the colors and flashing patterns is explained in the following table.

Visual signal		Meaning
	LED lights up yellow.	System start or initialization
	LED flashes yellow (slowly).	Ready for connection setup or locking
	LED flashes yellow (fast).	Connection setup started or locking underway
	LED lights up green.	Ready for operation
	LED flashes green (slowly).	In operation
	LED flashes red (fast).	Malfunction or error

Some system components only use part of the explained flashing patterns.



4 Delivery and packaging

4.1 Delivery

Inspect the delivery immediately upon receipt:

- Check the delivery against the delivery note to ensure completeness.
- Check the product for damage.
- If the delivery is incomplete or damaged, contact your regional Metrohm representative.

4.2 Packaging

The product and accessories are supplied in protective special packaging. Keep this packaging to ensure safe transportation of the product. If a transport locking device is present, keep this as well for future reuse.

5 Installation

5.1 OMNIS Rod Stirrer – Mounting to the electrode holder

Accessories:

- Stirring propeller (6.01900.0X0)

Proceed as follows:

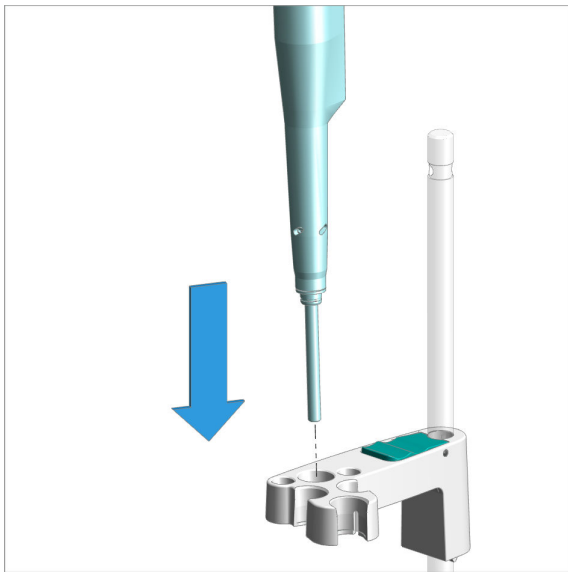

Inserting the rod stirrer

Insert the rod stirrer without the stirring propeller from above into the center opening of the electrode holder.

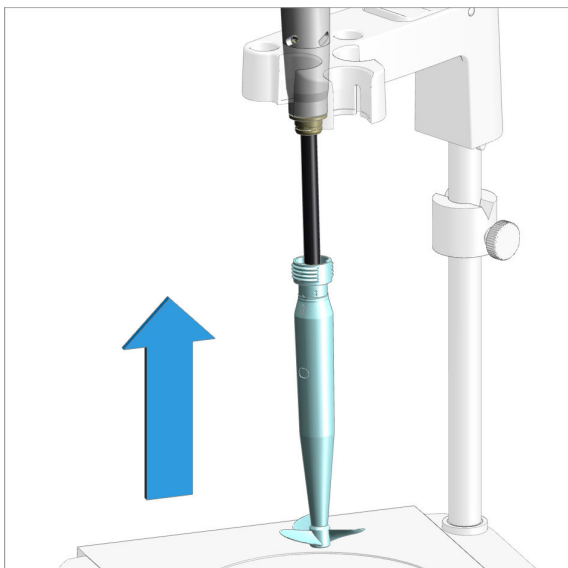

Mounting the stirring propeller

Plug the stirring propeller from below to the rod stirrer.

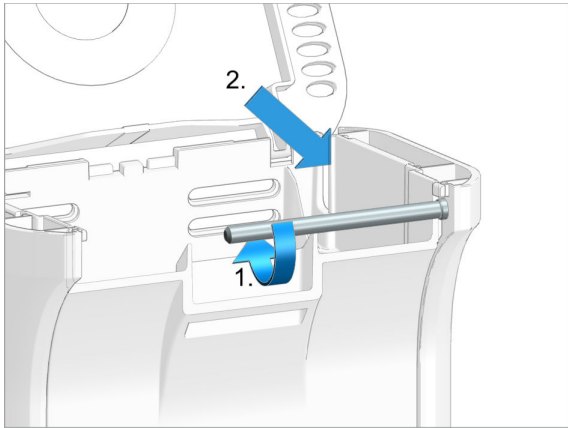

Guiding the cable to the rear of the instrument

1. Guide the cable under the bar and through into the instrument.
2. Guide the cable out of the instrument through the slot at the rear on the right.

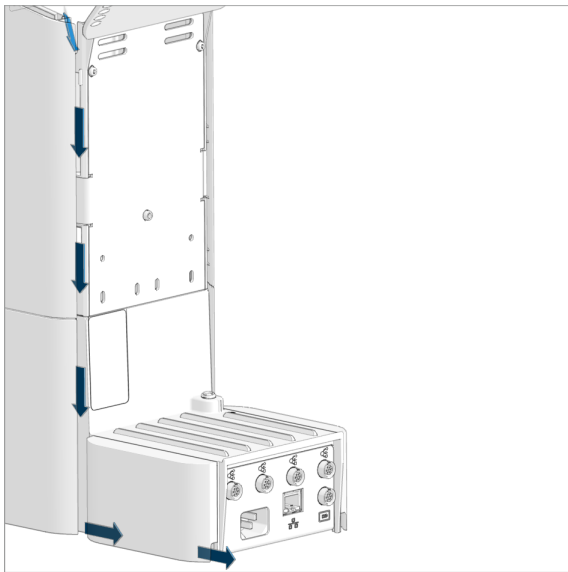

Threading the cable into the cable guide

First, thread the cable into the lateral cable guide.

Then guide the cable towards the rear under the lateral cladding at the rear.

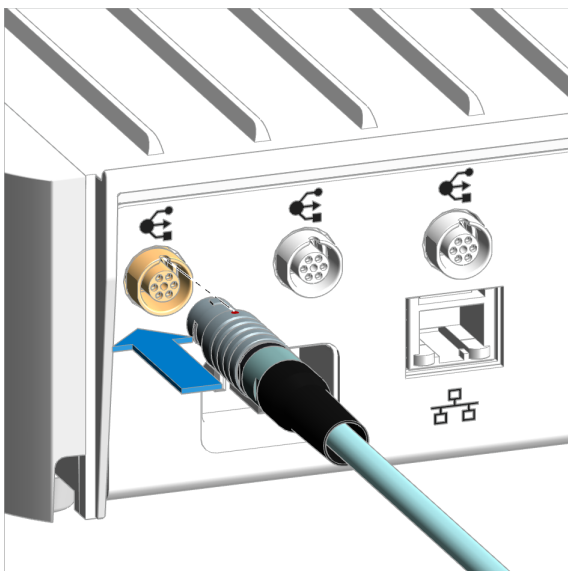

Plugging in the cable

Plug the cable of the rod stirrer into one of the MDL sockets on the instrument.

- i** It should be easy to plug in the cable. Do not apply force if the plug cannot be inserted easily! Rotate the plug to the right or left using light pressure until it latches in the socket.

5.2 OMNIS Rod Stirrer – Adjusting the stirring propeller height

Some of the stirring propellers of the rod stirrer have a length-adjustable shaft. A length-adjustable stirring propeller can be recognized by the marking at the end of the shaft.

The length can be adjusted in stages from 86 mm to 102 mm.

Adjusting the length of the stirring propeller

We recommend removing the stirring propeller from the rod stirrer before adjusting its length.

Proceed as follows to adjust the length of the stirring propeller:

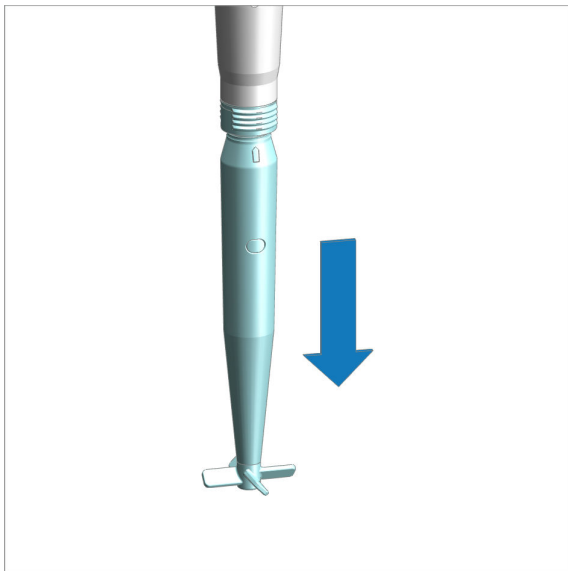

Hold the stirring propeller firmly on the corrugations and pull it off of the rod stirrer.

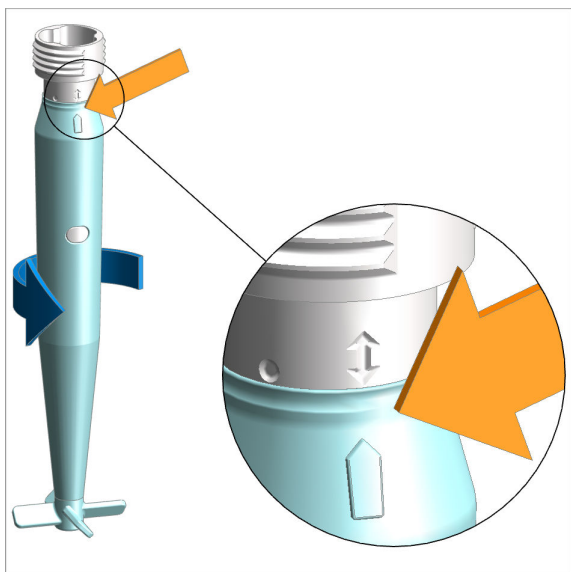

- Firmly hold the top part of the stirring propeller (with the corrugation).
- Rotate the shaft counterclockwise until the marking points to the position with the two arrows.

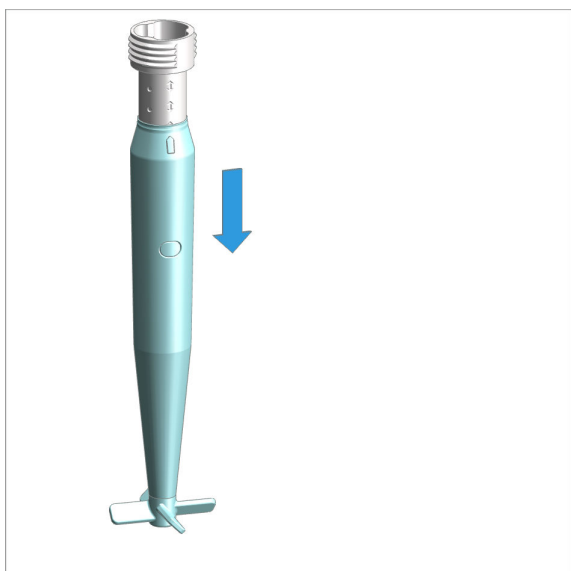

Pull the shaft downwards.

Each of the increments is marked with a double arrow and a dot.



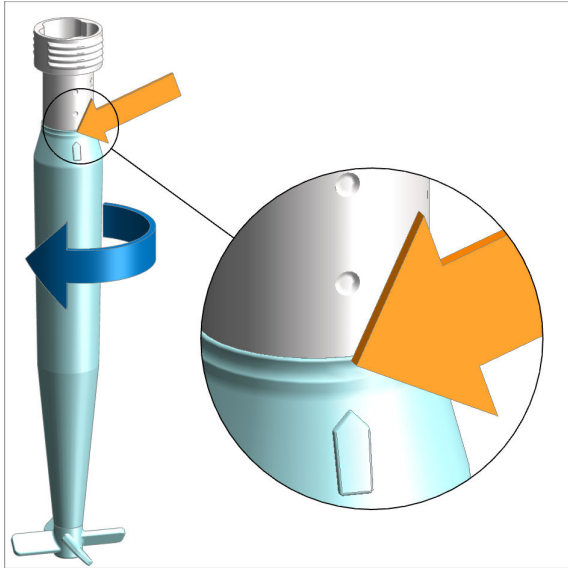

Rotate the shaft clockwise until the marking points to the position with the dot.
The length setting has engaged.

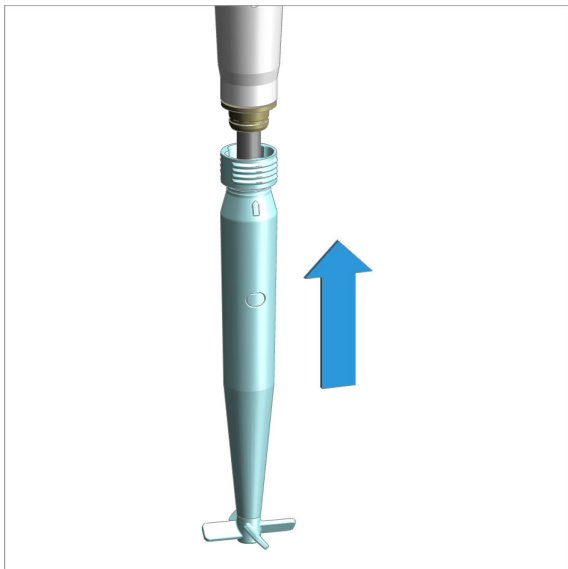

Plug the stirring propeller back into the rod stirrer.

6.3 Setting the stirring rate of the OMNIS Rod Stirrer

The stirring rate of the OMNIS Rod Stirrer can be adjusted two different ways:

- Using the **Manual control** in the OMNIS Software
- Using the buttons of an OMNIS magnetic stirrer, for which the prerequisite is to have this function switched on in the OMNIS Software beforehand.

To operate the OMNIS Rod Stirrer using the buttons of a magnetic stirrer, activate this function in the OMNIS Software at **Instruments ▶ Properties ▶ Specific data ▶** .

Cleaning the rod stirrer

CAUTION

Instrument damage through inward seepage of liquid

Property damage to the instrument or malfunction through the inward seepage of liquids (e.g. when cleaning).

The instrument is not resistant to splash water. Water can seep into the interior during cleaning and cause damage (e.g. to the electronics).

- Do not clean the instrument under running water.
- Do not use a wash bottle to clean the instrument.
- Only wipe the instrument thoroughly with a damp cloth.

Proceed as follows:

- 1 Rub the rod stirrer housing with a damp cloth.

7.3 OMNIS Rod Stirrer – Replacing the stirring propeller

Replace the stirring propeller in the following cases:

- If the stirring propeller is damaged (e.g., stirrer blade broken off).
- When adhesions can no longer be removed from the stirring propeller.

Also set the correct length of the stirring propeller at the same time that it is being replaced, .

8 Troubleshooting

Messages on malfunctions and errors are displayed in the control software or in the embedded software (e.g. on the display of an instrument) and contain the following information:

- Descriptions of causes of malfunctions (e.g. jammed drive)
- Descriptions of problems with the control (e.g. missing or invalid parameter)
- Information on how to solve the problem

System components with status display elements also indicate malfunctions and errors with a red flashing LED.

Troubleshooting on the product is often only possible with the control software or the embedded software (e.g. initializing, moving to a defined position).

See also

[System – Signals \(chapter 3.3, page 11\)](#)

9 Disposal

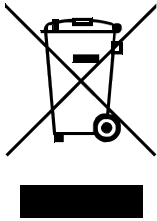

Properly dispose of chemicals and of the product to reduce negative effects on the environment and public health. Local authorities, waste disposal companies or dealers provide more detailed information on disposal. Observe the WEEE EU directive (WEEE = Waste Electrical and Electronic Equipment) for the proper disposal of waste electronic equipment within the European Union.



10 Technical specifications

10.1 Ambient conditions

Nominal function range	+5 to +45 °C	at max. 80% relative humidity, non- condensing
------------------------	--------------	--

Storage	+5 to +45 °C
---------	--------------

10.2 OMNIS Rod Stirrer – Energy supply

Nominal voltage	24 VDC
-----------------	--------

10.3 OMNIS Rod Stirrer – Dimensions

Measurements

<i>Width</i>	29 mm
<i>Height</i>	358 mm
<i>Depth</i>	24 mm

Weight

<i>Cable length 1.1 m</i>	170 g
<i>Cable length 2.5 m</i>	210 g

10.4 OMNIS Rod Stirrer – Housing

Materials

<i>Enclosure</i>	PP	polypropylene with 30% talcum
------------------	----	-------------------------------

IP degree of protection	IP 40	
-------------------------	-------	--

10.5 OMNIS Rod Stirrer – Connectors specifications

Energy supply		via MDL
<i>Socket</i>		round plug

MDL	Metrohm Device Link	
-----	---------------------	--

10.6 Display specifications

Status display	LED	multi-colored
----------------	-----	---------------

10.7 OMNIS Rod Stirrer – Stirrer specifications

Adjustment range for rotational speed	+1 - +15	Rotation in counter-clockwise direction (seen from above)
	-1 - -15	Rotation in clockwise direction (seen from above)

Rotational speed change per step	150 rpm	
----------------------------------	---------	--

Maximum rotational speed	2,250 rpm	
--------------------------	-----------	--

Diameter of the stirring propeller	13, 20 and 30 mm	
------------------------------------	------------------	--

Lengths of the stirring propeller	96 - 111 mm, 88 - 104 mm	adjustable in 5 steps
-----------------------------------	--------------------------	-----------------------