

Installation instruction: MVA-24 – 884 Professional VA fully automated for CVS with 858 Professional Sample Processor and Dosino sample transfer

The «MVA-24» is a fully automated system for the determination of suppressor, brightener, and leveler in plating solutions. The measurement of the sample volume and the transfer from the rack of the sample changer to the measuring instrument is done by means of an 800 Dosino.

Important features:

- Automatic addition of four fixed solutions, two with larger volumes (e.g., two different VMS) and two with smaller volumes, like suppressor and brightener concentrate.
- Automatic addition of variable solutions taken from the sample changer, e.g., suppressor standard solution, leveler standard solution, or plating bath sample.
- Automatic rinsing of the measuring vessel.
- Applications:
 - Determination of the suppressor concentration in plating baths with CVS or CPVS.
 - Determination of the brightener concentration in plating baths with CVS or CPVS.
 - Determination of the leveler concentration in plating baths with CVS or CPVS.



Figure 1. Components of an MVA-24 system.

Content

1	Instruments and accessories	2
2	System setup	2
2.1	Electrical connections	2
2.2	Mounting the holder for Dosino	3
2.3	Tubing connections for automatic addition of solutions	3
2.4	Tubing connections for rinsing and draining of the measuring vessel	5
3	viva «Configuration»	6
3.1	Devices – 884 Professional VA	6
3.2	Sensors/Electrodes	6
3.3	807 Dosing Units	6
3.4	Solutions	7
3.5	Devices – 858 Professional Sample Processor	8
4	viva «Method»	8
4.1	Method run	8
4.2	Evaluation	11
5	Operation	11
5.1	General	11
5.2	Preparation of 807 Dosing Units	12
5.3	Conditioning in VMS	13
5.4	Suppressor determination	13
5.5	Brightener determination	14
5.6	Leveler determination	15
6	Multiple determinations from one vial – modifications	16
6.1	Configuration	17
6.2	Method	17
7	Comments	18
7.1	Storing 807 Dosing Units	18
7.2	Storing electrodes	18
7.3	Waste and rinsing container	18
7.4	894 Professional CVS	18
7.5	More 807 Dosing Units	18
7.6	Measuring vessel	18
7.7	Example methods	18

1 Instruments and accessories

Quantity	Article no.	
1	2.884.1210	884 Professional VA semi-automated for CVS with 2 Dosinos
1	2.858.0120	858 Professional Sample Processor for VA/CVS with Dosino sample transfer
2	2.800.0020	800 Dosino
1	6.5339.520	Equipment with two 807 Dosing Units 2 mL + 50 mL
1	2.843.0240	843 Membrane Pump Station for Professional VA/CVS systems
1	6.2141.300	Remote cable 843 Pump Station to Sample Processor
1	6.5339.xx0	CVS electrode equipment
1	6.6065.30x	viva 3.0

2 System setup

2.1 Electrical connections

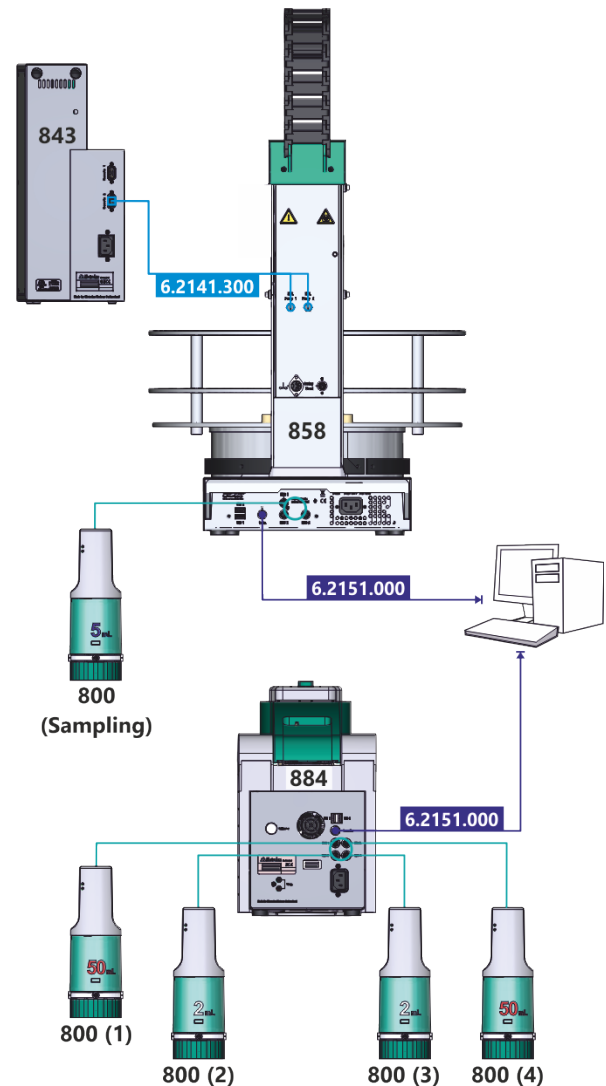

Figure 2. Electrical connections.

Please note!

- The cable 6.2141.300 must be connected to «Remote 2» of the 843 Pump Station.
- The 800 Dosinos can be connected to any of the MSB ports. The indicated number is only used to distinguish the 807 Dosing Units in this document.

2.2 Mounting the holder for Dosino

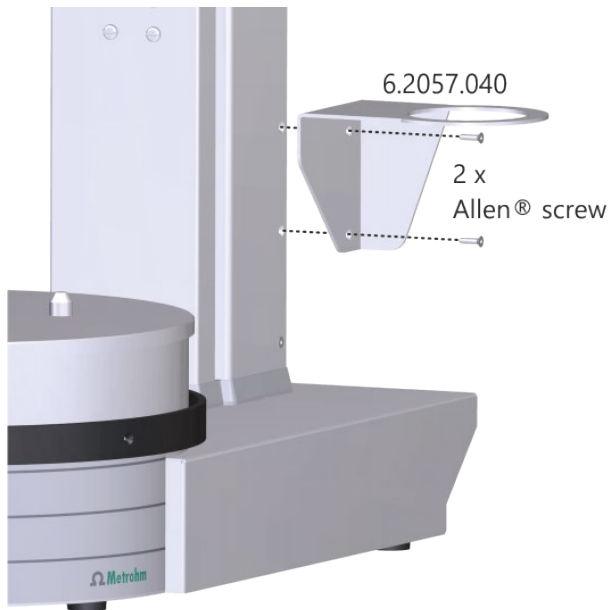

Figure 3. Mounting the holder for Dosino on the 858 Professional Sample Processor.

- Remove the second and third lowest screws on the right-hand side of the sample changer tower. This requires a Torx screwdriver size T10.
- Attach the holder for Dosino (6.2057.040) to the tower of the sample changer as shown in **Figure 3**. Use the Allen® screws provided in the scope of delivery of the holder and a 2 mm hex key.

2.3 Tubing connections for automatic addition of solutions

2.3.1 Overview

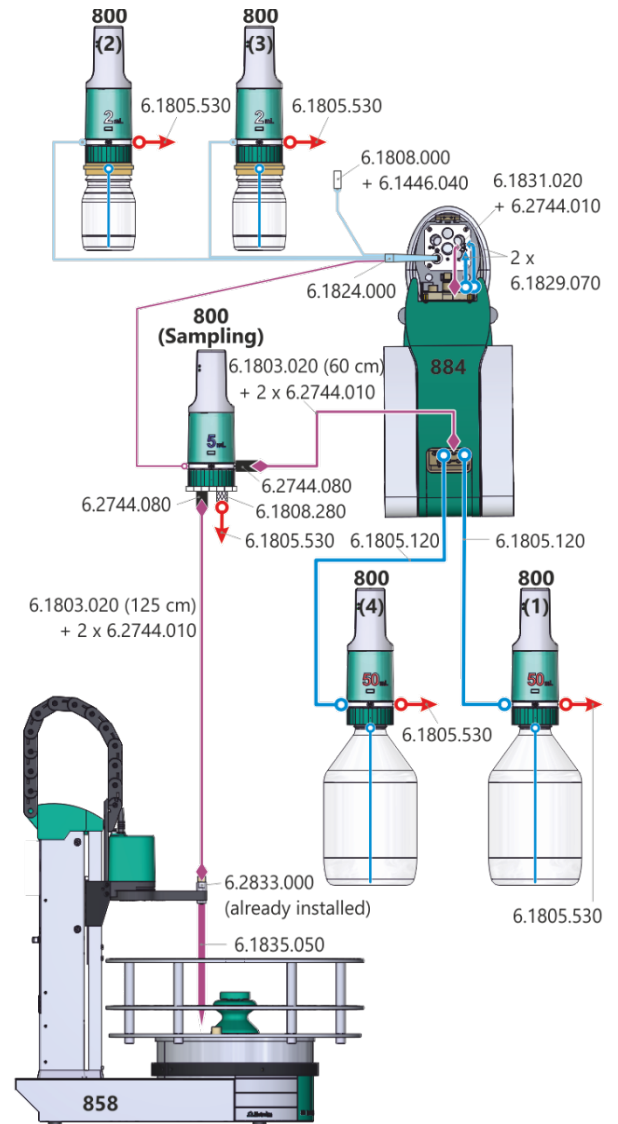

Figure 4. Overview of tubing connections for solution transfer.

2.3.2 Dosino for sample transfer

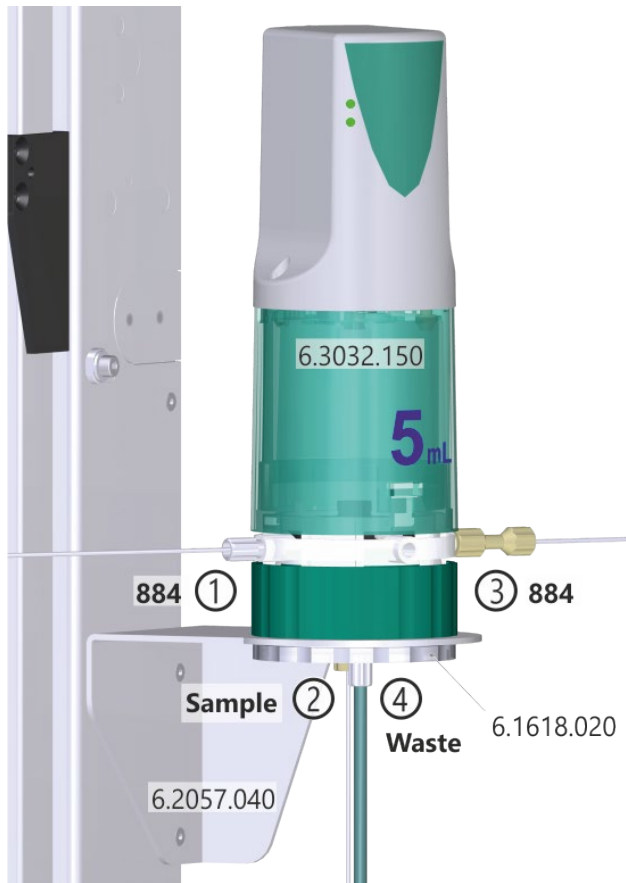

Figure 5. Details of the setup of the 5 mL dosing unit used for the transfer of solutions from the 858 Professional Sample Processor.

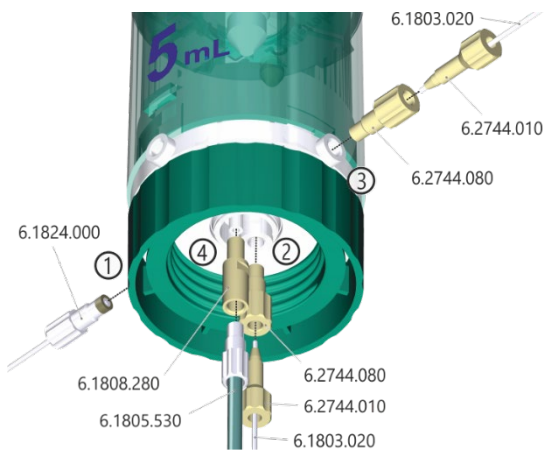

Figure 6. Details of tubing connections of the 5 mL dosing unit used for sample transfer.

2.3.3 807 Dosing Unit 2 mL

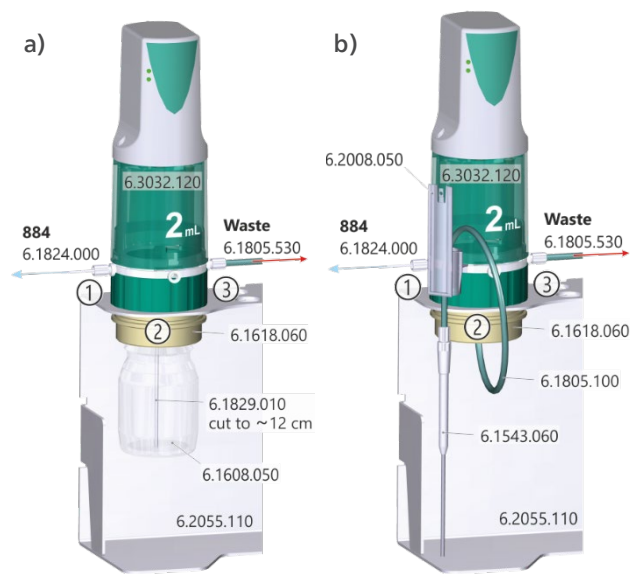

Figure 7. Options for the setup of tubing connections of the 2 mL dosing units used for addition of e.g., suppressor or brightener concentrate, a) with glass bottle if solutions do not need to be exchanged too often, and b) with tubing for easier exchange of solutions.

2.3.4 807 Dosing Unit 50 mL



Figure 8. Setup of tubing connections of the 50 mL dosing unit used for addition of e.g., VMS.

2.3.5 884 Professional VA

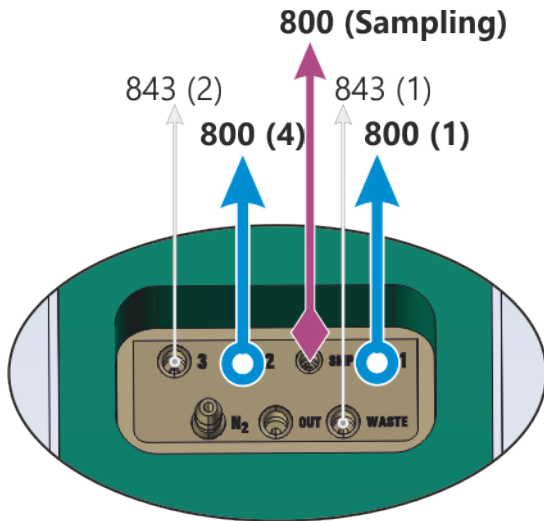

Figure 9. Details of the tubing connections for solution transfer on the tubing connector located on the back of the measuring head arm.

PEEK capillary
6.1831.020 +
6.2744.010

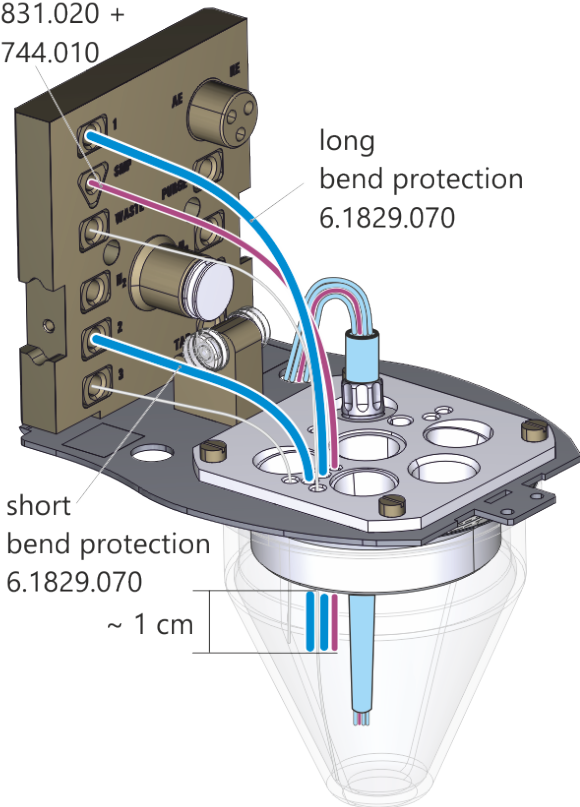

Figure 10. Details of the tubing connections for solution transfer in the measuring head.

2.4 Tubing connections for rinsing and draining of the measuring vessel

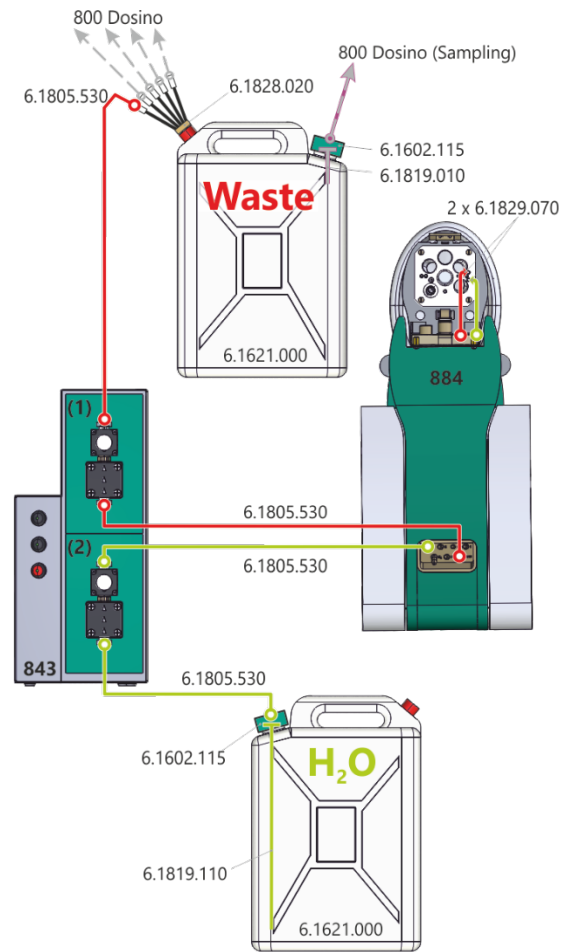

Figure 11. Overview of tubing connections for draining and rinsing.

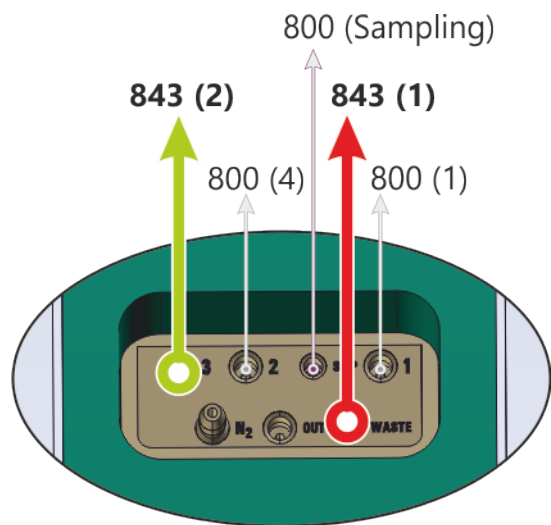

Figure 12. Details of the tubing connections for draining and rinsing on the tubing connector located on the back of the measuring head arm.

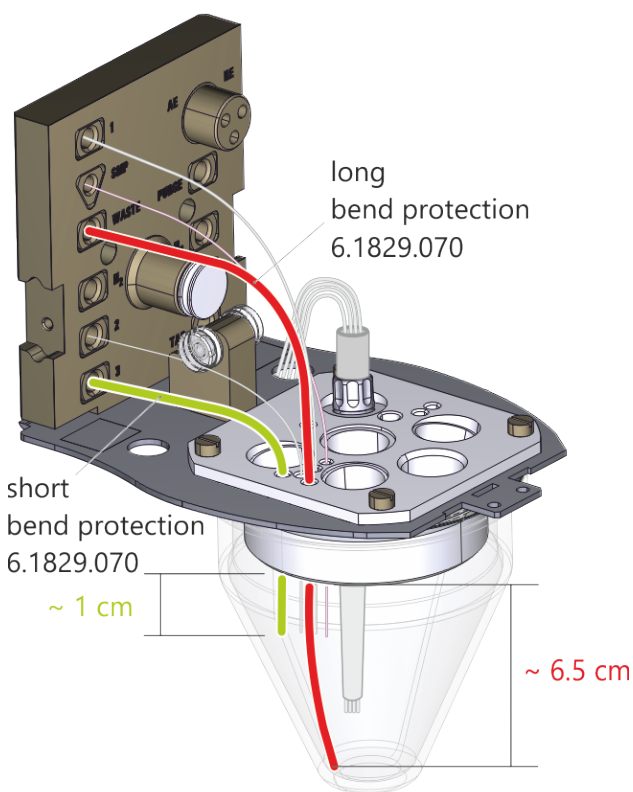
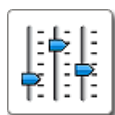

Figure 13. Details of the tubing connections for draining and rinsing in the measuring head.

3 viva «Configuration»



In addition to this Application Bulletin, it is recommended to have the following document available.

8.103.8010xx	viva Tutorial CVS
	In the following chapters, this document will be referred to as <i>Tutorial</i>

3.1 Devices – 884 Professional VA

The 884 Professional VA is automatically recognized by the **viva** software. When an instrument is connected for the first time, it needs to be entered in the **viva** «Configuration». The corresponding dialog will pop up automatically.

Device name	884_1
-------------	-------

For a step-by-step description, please see the Tutorial chapter «4.1.1 Configuring the instrument».

3.2 Sensors/Electrodes

A set of electrodes is already preinstalled in the **viva** «Configuration». The following three electrodes must be present if the measuring command is used as specified in the **viva** example methods provided with this Application Bulletin.

Sensor name	Sensor type
Auxiliary electrode	Auxiliary electrode
RDE	RDE/SSE
Reference electrode	Reference electrode

3.3 807 Dosing Units

An 807 Dosing Unit attached to an 800 Dosino which is connected to the 884 Professional VA is automatically recognized by the **viva** software. When the 807 Dosing Unit is connected for the first time, it needs to be entered in the **viva** «Configuration». The corresponding dialog will pop up automatically. For a step-by-step description, please see the *Tutorial* chapter «5.1.3 Configuring dosing units».

The following 807 Dosing Unit names correspond to the names used in the **viva** example methods provided with this document. However, 807 Dosing Unit names can be chosen freely, independent of which instrument and MSB port the Dosino is physically connected to.

3.3.1 5 mL dosing unit at 800 Dosino (Sampling)

Hardware

Name	5 mL Standard or sample
------	-------------------------

Parameters for preparation

Dosing port Prep/Empty	Special port	
Dosing rate Dosing port 1	2.0	mL/min
Dosing rate Dosing port 2	maximum	mL/min
Dosing rate Fill port	maximum	mL/min
Dosing rate Special port	maximum	mL/min

Tubing parameters

	Port	Length	Diameter
Dosing port 1	Port 1	80 cm	0.3 mm
Dosing port 2	Port 3	96 cm	1 mm
Fill port	Port 2	150 cm	1 mm
Special port	Port 4	0 cm	2 mm

Valve disk

Rotation direction	automatic
--------------------	-----------

3.3.2 50 mL dosing unit at 800 Dosino (1) and (4)

Hardware

Name (1)	50 mL VMS 1
Name (4)	50 mL VMS 2

Parameters for preparation

Dosing port Prep/Empty	Dosing port 2	
Dosing rate Dosing port 1	maximum	mL/min
Dosing rate Dosing port 2	maximum	mL/min
Dosing rate Fill port	maximum	mL/min
Dosing rate Special port	maximum	mL/min

Tubing parameters

	Port	Length	Diameter
Dosing port 1	Port 1	138 cm	2 mm
Dosing port 2	Port 3	0 cm	2 mm
Fill port	Port 2	30 cm	2 mm
Special port	Port 4	0 cm	2 mm

Valve disk

Rotation direction	automatic
--------------------	-----------

3.3.3 2 mL dosing unit at 800 Dosino (2) and (3)

Hardware

Name (2)	2 mL Suppressor
Name (3)	2 mL Brightener

Parameters for preparation

Dosing port Prep/Empty	Dosing port 2	
Dosing rate Dosing port 1	2.0	mL/min
Dosing rate Dosing port 2	maximum	mL/min
Dosing rate Fill port	maximum	mL/min
Dosing rate Special port	maximum	mL/min

Tubing parameters

	Port	Length	Diameter
Dosing port 1	Port 1	80 cm	0.3 mm
Dosing port 2	Port 3	0 cm	2 mm
Fill port	Port 2	12/55 cm*	2 mm
Special port	Port 4	0 cm	2 mm

Valve disk

Rotation direction	automatic
--------------------	-----------

* Depends on the setup of the 807 Dosing Unit 2 mL: for **Figure 7**, a) 12 cm and b) 55 cm.

3.4 Solutions

Solutions that should be added automatically must be defined in the **viva** «Configuration» and need to be assigned to the 807 Dosing Unit which is used for the addition. For a step-by-step description, please see the *Tutorial* chapter «5.1.4 Defining solutions».

Table 1 shows the solution names and corresponding 807 Dosing Units as used in the **viva** example methods.

Table 1. 807 Dosing Units and solutions.

Solution name	Type*	807 Dosing Unit
VMS 1	A	50 mL VMS 1
VMS 2	A	50 mL VMS 2
Suppressor concentrate	A	2 mL Suppressor
Brightener concentrate	S	2 mL Brightener
Sample or standard	S	5 mL Standard or sample

*Solution type: A = auxiliary solution, S = standard solution

3.5 Devices – 858 Professional Sample Processor

The 858 Professional Sample Processor is automatically recognized by the **viva** software. When an instrument is connected for the first time, it needs to be entered in the **viva** «Configuration». The corresponding dialog will pop up automatically.

Device name	858 Sample Processor
-------------	----------------------

For a step-by-step description, please see the *Tutorial* chapter «6.1.1 Configuring the instrument».

3.5.1 Tower

Tower parameters

Max. stroke path	127	mm
Min. beaker radius	off	
Lift rate	25	mm/s
Axial distance	166.0	mm

Swing Head

Swing position	0	mm
Rinse position	0	mm
External position	Not used	

3.5.2 Rack

Rack name	6.2041.450	
Shift rate	20	°/s

3.5.3 Rack data

Rack parameters

Beaker radius samples	off	
Beaker sensor	off	
Rack offset	0	°

Lift positions – Tower 1

Work position	126	mm
Rinse position	0	mm
Shift position	0	mm
Special position	0	mm

Lift positions – Tower 2

Work position	Not available
Rinse position	Not available
Shift position	Not available
Special position	Not available

Special beakers

Not used	
----------	--

4 viva «Method»



This Application Bulletin comes with six example methods using the described hardware setup:

- 800105029EN – MVA-24 - Conditioning in VMS
- 800105029EN – MVA-24 - Suppressor (CVS, DT)
- 800105029EN – MVA-24 - Brightener (CVS, MLAT)
- 800105029EN – MVA-24 - Leveler determination (CVS, RC)
 - With dilution
 - No dilution
- 800105029EN – MVA-24 - Preparation of dosing units

The example methods already establish the basic sequences for the different applications, the use of 800 Dosinos for automatic addition, the application of a sample changer and pumps to process a sample series, as well as the calculation of the result. However, certain commands and settings have to be adapted to the used hardware and the requirements of the specific application.

4.1 Method run

The following commands must be adapted:

4.1.1 Measuring commands

CVS
CVS

- If the name of the 884 Professional VA differs from the specifications in section 3.1, then assign the correct instrument name.
- Adapt the measuring parameters on the tabs «Pre-treatment», «Sweep», «Post-treatment», and «Potentiostat» according to the requirements of the application. These parameters can be found in separate application documentation.

4.1.2 Dosing commands

ADD STD	ADD STD	ADD STD
Add standard	Add standard DT	Add standard RC

- Define the volume of solution that should be added when this command is due.
- If the name of the solution differs from the specifications in 3.4, select the correct solution name under Standard – Solution in the properties of the command.

Please Note!

The name of solutions added with the sampling Dosino must be identical for all methods. This also applies to the standard solutions placed on the rack which are added in the commands **ADD STD – ADD STANDARD DT** and **ADD STD – ADD STANDARD RC**. It is not possible to have different solution names assigned to the same 807 Dosing Unit.

ADD AUX	ADD AUX	ADD AUX
Add VMS xxx	Add suppressor xxx	Add brightener xxx

- Select the solution and volume which should be added when this command is due.

ADD SAMPLE
Sample volume

- See chapter 4.1.5.

ADD SAMPLE DT
Add sample DT

- Define the volume of solution that should be added when this command is due.
- If the name of the 807 Dosing Unit differs from the specifications in 3.3, check on the tab

«General/Hardware» that the correct 807 Dosing Unit is assigned. It has to be the one used for sampling.

LQH	LQH	LQH
Fill 5 mL Sample/Stand...	Fill 50 mL VMS #	Fill 2 mL Suppressor

LQH
Fill 2 mL Brightener

- If names of the 807 Dosing Units differ from the specifications in 3.3, then check on the tab «General/Hardware» of the respective command that the correct 807 Dosing Unit is assigned.

4.1.3 Automation commands

Such as:

MOVE	MOVE
Move to sample position	Move to rinsing vial 28

LIFT	LIFT
Needle → Work: position	Needle → Shift position

- If the name of the 858 Professional Sample Processor differs from the specifications in 3.5, assign the correct sample processor name.

4.1.4 Preparation of 807 Dosing Unit «5 mL Standard or sample»

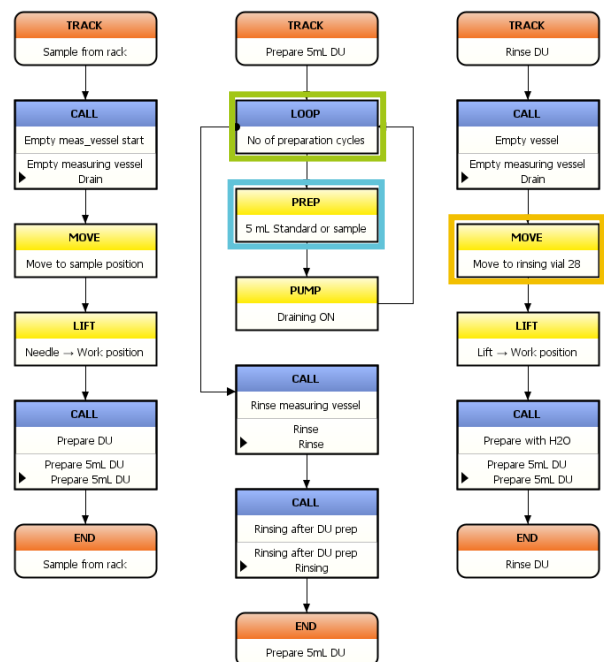

Figure 14. Method snippet: preparation of 807 Dosing Unit «5 mL Standard or sample» with solution from the rack of the sample changer or with water for rinsing.

Figure 14 shows the tracks **SAMPLE FROM RACK** and **PREPARE 5mL DU** which control the preparation of the 807 Dosing Unit for sampling. The number of preparation cycles is specified in the command **LOOP – NO OF PREPARATION CYCLES** using a formula. If the preparation is called up from the command **CALL – PREP STANDARD OR SAMPLE** and the number for «Prep cycles» (ID3) on the workplace is equal to or larger than 1, then the preparation of the 807 Dosing Unit is repeated as many times as specified for «Prep cycles». Otherwise, if no value is entered on the workplace or the preparation is called up from e.g., the **SERIES END** track, the 807 Dosing Unit is prepared only once.

If the name of the 807 Dosing Unit differs from the setting in 3.3.1, check in the command **PREP – 5 mL STANDARD OR SAMPLE** on the tab «General/Hardware» that the correct 807 Dosing Unit is assigned.

After the calibration with leveler standard, and always at the end of a sample series, the 807 Dosing Unit for sampling is rinsed with water. This is controlled in the **RINSE DU** track shown in Figure 14. The water for rinsing is placed on the rack in position 28. If a different position should be used, it must be specified in the command **MOVE – MOVE TO RINSING VIAL 28**.

4.1.5 Dosing larger sample volumes with «5 mL Standard or sample» via port 3

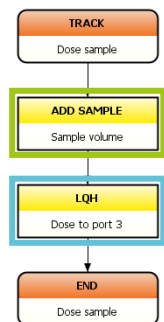

Figure 15. Method snippet: adding sample via port 3.

If volumes >1 mL should be added with the sampling Dosino, it is recommended to add via port 3. A tubing with a larger inner diameter is connected to this port which allows a higher dosing rate. With an **ADD SAMPLE** command, solutions are always added from port 1. The selection of the dosing port is only possible with a **LQH** command, which is why the addition of sample via port 3 requires two commands as shown in Figure 15. If the name of the 807 Dosing Unit differs from the specifications in 3.3, check on the tab «General/Hardware» in the command **LQH – DOSE TO PORT 3** that the correct 807 Dosing Unit is assigned.

If a volume ≤1 mL should be added, delete the command **LQH – DOSE TO PORT 3** and select the corresponding 807 Dosing Unit in the command **ADD SAMPLE – SAMPLE VOLUME** after changing the option for «Addition» to «Add with dosing device».

The sample volume is always taken from the parameter «Sample amount» on the workplace.

4.1.6 Rinsing measuring vessel

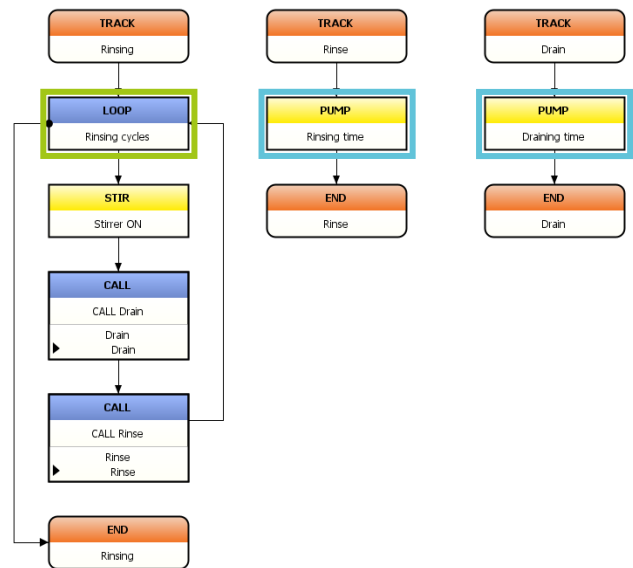

Figure 16. Method snippet: draining and rinsing the measuring vessel.

After preparation of the 807 Dosing Unit «5 mL Standard or sample», and after each sample, the measuring vessel needs to be rinsed with deionized water. The tracks in which the draining and rinsing are controlled are shown in Figure 16. The rinsing and draining times are defined in the corresponding commands **PUMP – RINSING TIME** and **PUMP – DRAINING TIME**. The number of rinsing cycles is defined in the command **LOOP – RINSING CYCLES**.

The rinsing and draining times depend on the total volume used in the determination. For examples see Table 2. It is recommended to test these pump times with the particular setup.

Please note!

The device assigned to the commands **PUMP – RINSING TIME** and **PUMP – DRAINING TIME** must be the 858 Professional Sample Processor, since the 843 Pump Station is connected to and controlled from the sample changer.

Table 2. Examples for draining and rinsing settings depending on the cell volume.

Cell volume	50 mL	100 mL
Number of rinsing cycles	1	1
Draining time	35 s	50 s
Rinsing time	9 s	18 s

4.2 Evaluation

Settings regarding evaluation and documentation of the determination are located in the «Evaluation» part of the method. The example methods already include all necessary settings to determine the brightener, suppressor, or leveler concentration in an acid copper bath. If modifications should be necessary, the following subsections explain where important parameters are found.

4.2.1 Substances

In the «Substances» part, settings for peak recognition and baseline parameters are defined.

4.2.2 Standards

In the «Standards» part, the concentration of the used standard solution is defined.

Please note!

If the names for standard solutions differ from the specifications 3.4 make sure that the name of the solution in the **ADD STD xx** command (Method run) matches the name of the solution under Evaluation – Standards.

4.2.3 Calibration

In the «Calibration» part, the calibration method, such as DT, MLAT or RC, is defined as well as the regression type of the calibration curve.

4.2.4 Results

Amongst other things, settings for the automatically calculated final results can be adjusted and the database for the storage of the results can be defined in the «Results» part.

5 Operation

5.1 General

In general, samples and solutions can be freely positioned on the rack (see **Figure 17**), and different applications can be combined in one determination series.

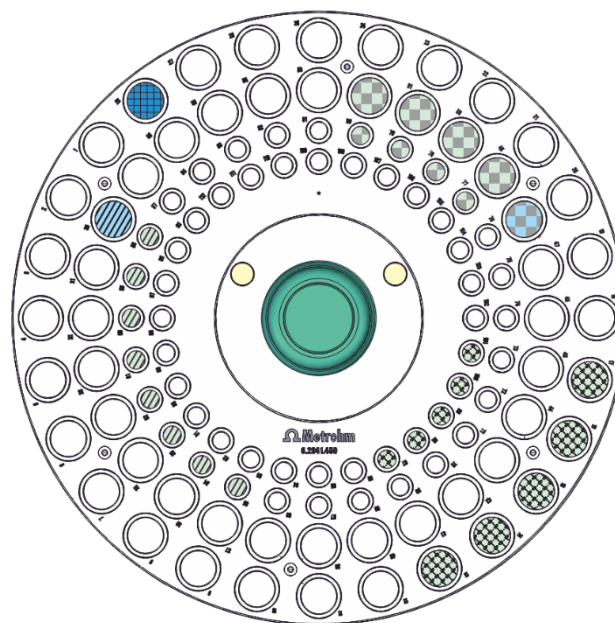







-  Rinsing solution (Position 28)
-  Suppressor – Standard solution
-  Suppressor – Sample
-  Brightener – Sample (>5 mL / ≤5 mL)
-  Leveller – Standard solution
-  Leveller – Sample (>5 mL / ≤5 mL)

Figure 17. Example for positions of solutions on the rack 6.2041.450.

Nevertheless, certain points should be considered when placing the solutions.

- Water has to be placed in position 28 to rinse the 807 Dosing Unit «5 mL Standard or sample» at the end of the sample series. This position is pre-programmed in all example methods provided with this document. If a different position is used for this purpose, then the methods must be adapted accordingly.
- The methods do not include a special rinsing step between samples for 807 Dosing Unit «5 mL Standard or sample». The 807 Dosing Unit is only prepared with the next solution. If additional rinsing is required, the preparation is repeated a second time. For this purpose, all determination methods come with the parameter «Prep cycles», which allows the user to set the number of preparation cycles on the workplace.

- Usually one preparation cycle is sufficient between samples.
- Cases where two preparation cycles are recommended:
 - After the 807 Dosing Unit has been rinsed with water, e.g., in the first determination of a series or in the determination directly after a calibration with leveler standard.
 - When concentrations are very different, e.g., preparation with leveler standard within a series of samples.
 - When the 807 Dosing Unit is prepared with a standard solution which should be used for calibration.
 - When the chemistry between two samples is not compatible.
- On rack 6.2041.450, samples can be placed in positions with vials for 50 mL as well as for 11 mL. However, it is important to note that one preparation cycle requires a volume of approx. 10 mL. With two preparation cycles, it is 20 mL. Consequently, the 807 Dosing Unit can only be prepared once when 11 mL volume is available, which is why samples that require two preparation cycles (see above) must be placed in positions for 50 mL. The volume required for the application must be increased by the volume required for the preparation.
- The maximum sample volume which can be used with an 11 mL vial is 5 mL. Samples for applications that require more than 5 mL sample volume must be placed in positions for 50 mL.
- Multiple additives can be determined (e.g., suppressor, brightener, leveler) with the sample from one vial without additional preparation of the 807 Dosing Unit «5 mL Standard or sample». For required adjustments in software and methods, please check chapter 6 in this document.

5.2 Preparation of 807 Dosing Units

For startup or shutdown of the system, the preparation of 807 Dosing Units can be done from the **viva** «Manual control». But more conveniently, the 807 Dosing Units can be prepared using the method «800105029EN – MVA-24 - Preparation of dosing units», which is provided with this Application Bulletin. The method allows the user to specify the number of preparation cycles individually for each 807 Dosing Unit on the workplace as shown in **Figure 18**.

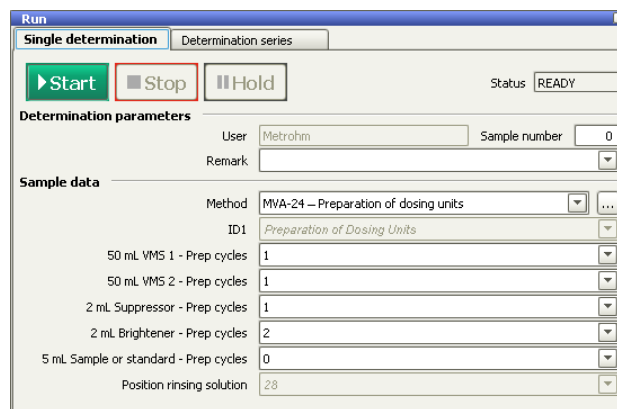

Figure 18. Example for the settings in the «Run» window to prepare the 807 Dosing Units using the method «800105029EN – MVA-24 - Preparation of dosing units».

Features of the method:

- The preparation of the 807 Dosing Unit is repeated as many times as specified on the workplace, 1 = once, 2 = twice, etc.
- If «Prep cycles» = 0, the respective 807 Dosing Unit is not prepared.
- All 807 Dosing Units with «Prep cycles» > 0 will be prepared simultaneously.
- 807 Dosing Unit «5 mL Standard or sample» is usually prepared within the determination methods with solution from the rack of the sample changer. The consequence for a manual preparation is that the intended solution also needs to be placed on the rack and the position needs to be specified. In this method, this is covered by the parameter «Position rinsing solution» (see **Figure 18**). When the 807 Dosing Unit «5 mL Standard or sample» should be prepared, the sample changer moves to the specified position and immerses the needle into the solution. In the example, the position is fixed at number 28, just as in the determination methods.
- At the beginning of the method and after each preparation cycle of an 807 Dosing Unit, the waste pump of the 843 Pump Station drains the measuring vessel.
- When the preparation of all 807 Dosing Units is finished, the measuring vessel will be rinsed with water.

Please note!

When the method «800105029EN – MVA-24 - Preparation of dosing units» should be used in a sample series, make sure that ID1 to ID7 are activated for the tab

«Determination series» under «Properties run window» on the tab «Display».

5.3 Conditioning in VMS

5.3.1 Manual operation



- 807 Dosing Unit «50 mL VMS 1» has to be prepared with VMS 1.

Only when carried out within a sample series:

- A 50 mL vial (6.2747.010) with deionized water for rinsing of the 807 Dosing Unit «5 mL Standard or sample» is placed in position 28 on the sample rack.

5.3.2 Workplace



- This method does not require any solution from the rack of the sample changer, which is why no sample position needs to be entered when the method is used within a sample series.
- The sample amount is fixed at 30 mL, which is the volume of VMS required to condition the electrodes when measuring vessel 6.1415.250 is used (see also section 7.6).

5.3.3 Course of events

The conditioning of the electrodes is controlled by the 884 Professional VA and **viva**.

- The measuring vessel is emptied using the 843 Pump Station.
- VMS 1 is automatically added from 807 Dosing Unit «50 mL VMS 1».
- The CVS sweeps are repeated until either the relative standard deviation of the Cu stripping peak is <0.5% or for 20 runs, whatever condition is met first.
- At the end of the conditioning, the measuring vessel is automatically emptied and rinsed using the 843 Pump Station.

5.4 Suppressor determination

5.4.1 Manual operation



- 807 Dosing Unit «50 mL VMS 1» has to be prepared with VMS 1.
- Suppressor standard solutions and plating bath samples are placed on the sample rack. When the 807 Dosing Unit «5 mL Standard or sample» should only be prepared once, solutions can be placed in positions 57 to 112 using sample vials for 11 mL (6.2743.057). When the 807 Dosing Unit should be prepared twice (e.g., for suppressor standard solution), at least 20 mL solution must be placed in positions 1 to 56 using the 50 mL sample vials (6.2747.010).
- A 50 mL vial (6.2747.010) with deionized water for rinsing of the 807 Dosing Unit «5 mL Standard or sample» is placed in position 28 on the sample rack.

5.4.2 Workplace



- In the «Run» window on the tab «Determination series» create a sample table:

	Method	ID1	ID2	ID3	Sample type	Sample position	Sa...	Sa...
1	MVA-24 – Suppressor (CVS, DT)	Suppressor standard	Calibration Suppressor	2	Standard	30		
2	MVA-24 – Suppressor (CVS, DT)	Check Standard	Suppressor determination		Sample	58		
3	MVA-24 – Suppressor (CVS, DT)	Sample	Suppressor determination		Sample	59		
4	MVA-24 – Suppressor (CVS, DT)	Sample	Suppressor determination		Sample	60		
5	MVA-24 – Suppressor (CVS, DT)	Sample	Suppressor determination		Sample	61		
6	MVA-24 – Suppressor (CVS, DT)	Sample	Suppressor determination		Sample	62		
7	MVA-24 – Suppressor (CVS, DT)	Sample	Suppressor determination		Sample	63		
8	MVA-24 – Suppressor (CVS, DT)	Sample	Suppressor determination		Sample	64		
9	MVA-24 – Suppressor (CVS, DT)	Sample	Suppressor determination		Sample	65		
▶ *								

Figure 19. Example sample table for suppressor calibration and determination with solutions positioned as shown in Figure 17.

- To run a calibration with a standard solution, select the sample type **STANDARD**. For a determination, the sample type **SAMPLE** has to be selected.
- No «Sample amount» needs to be defined in the sample table, since addition volumes for the standard and the sample are defined in the method commands **ADD STD** and **ADD SAMPLE DT**.
- Enter the number of «Prep cycles» for the 807 Dosing Unit «5 mL Standard or sample» if they should differ from 1 (ID3 in Figure 19). If no value is entered, the 807 Dosing Unit will be prepared once. See chapter

5.1 for recommendations regarding number of preparation cycles.

- The rinsing of the 807 Dosing Unit «5 mL Standard or sample» with water at the end of the sample series does not need to be defined in the sample table. It is pre-programmed in the **SERIES END** track of the method.

5.4.3 Course of events

The execution of calibration and determination by dilution titration is controlled by the 884 Professional VA and **viva**.

1. The measuring vessel is emptied using the 843 Pump Station.
2. 807 Dosing Unit «5 mL Standard or sample» is automatically prepared with suppressor standard or sample from the vial on the rack of the sample changer. The preparation is repeated as many times as specified for «Prep cycles» (ID3 in **Figure 19**). In the example above, the preparation would be carried out twice with the standard solution for the calibration and only once for the check standard and for all samples.
3. The measuring vessel is emptied and rinsed using the 843 Pump Station.
4. VMS 1 is automatically added from the 807 Dosing Unit «50 mL VMS 1».
5. After determination of the VMS value, a suppressor standard or plating bath sample is added via port 1 of the 807 Dosing Unit «5 mL Standard or sample» until the signal ratio $Q/Q(0)$ is reached.
6. The software calculates the calibration factor for the calibration or the concentration of suppressor in the plating bath sample.
7. At the end of each determination the measuring vessel is automatically emptied and rinsed using the 843 Pump Station.

The next sample starts again from 1.

- Recalibration within a determination series is possible.
- At the end of a determination series, the 807 Dosing Unit «5 mL Standard or sample » is automatically prepared with rinsing water placed in position 28.

5.5 Brightener determination

5.5.1 Manual operation



- 807 Dosing Unit «50 mL VMS 2» has to be prepared with VMS 2.
- 807 Dosing Unit «2 mL Brightener» has to be prepared with brightener concentrate.
- 807 Dosing Unit «2 mL Suppressor» has to be prepared with suppressor concentrate.
- Plating bath samples are placed in positions 1 to 56 of the rack using the 50 mL sample vials (6.2747.010). It is not necessary to measure the exact sample volume as this will automatically be done using 807 Dosing Unit «5 mL Standard or sample».
- A 50 mL vial (6.2747.010) with deionized water for rinsing of the 807 Dosing Unit «5 mL Standard or sample» is placed in position 28 on the sample rack.

5.5.2 Workplace



- In the «Run» window on the tab «Determination series» create a sample table:

	Method	ID1	ID2	ID3	Sample type	Sample position	Sample amount	Sa...
1	MVA-24 – Brightener (CVS, MLAT)	Check Standard	Brightener determination		Sample	7	10	mL
2	MVA-24 – Brightener (CVS, MLAT)	Sample	Brightener determination		Sample	8	10	mL
3	MVA-24 – Brightener (CVS, MLAT)	Sample	Brightener determination		Sample	9	10	mL
4	MVA-24 – Brightener (CVS, MLAT)	Sample	Brightener determination		Sample	10	10	mL
5	MVA-24 – Brightener (CVS, MLAT)	Sample	Brightener determination		Sample	11	10	mL
▶ *								

Figure 20. Example sample table for brightener determination with solutions positioned as shown in **Figure 17**.

- **SAMPLE** has to be selected as the sample type.
- The volume entered for «Sample amount» will be automatically added when the addition of sample is due in the determination.
- Enter the number of «Prep cycles» for 807 Dosing Unit «5 mL Standard or sample» if they should differ from 1 (ID3 in **Figure 20**). If no value is entered, the 807 Dosing Unit will be prepared once. See chapter 5.1 for recommendations regarding number of preparation cycles.
- The rinsing of 807 Dosing Unit «5 mL Standard or sample» with water at the end of the sample series does not need to be defined in the sample table. It is pre-programmed in the **SERIES END** track of the method.

5.5.3 Course of events

The execution of the determination by modified linear approximation technique is controlled by the 884 Professional VA Professional VA and **viva**.

1. The measuring vessel is emptied using the 843 Pump Station.
2. 807 Dosing Unit «5 mL Standard or sample» is automatically prepared with the sample from the vial on the rack of the sample changer. The preparation is repeated as many times as specified for «Prep cycles» (ID3 in **Figure 20**). In the example above, the preparation would be carried out once for the check standard as well as for each of the samples.
3. The measuring vessel is emptied and rinsed using the 843 Pump Station.
4. The intercept solution is automatically prepared by adding VMS 2 from the 807 Dosing Unit «50 mL VMS 2» and suppressor concentrate from «2 mL Suppressor».
5. After determination of the intercept value, the volume of plating bath sample, as specified under sample amount, is added via port 3 of the 807 Dosing Unit «5 mL Standard or sample».
6. Standard additions are carried out automatically using 807 Dosing Unit «2 mL Brightener».
7. The software calculates the concentration of brightener in the plating bath sample.
8. At the end of each determination, the measuring vessel is automatically emptied and rinsed using the 843 Pump Station.

The next sample starts again from step 1.

- At the end of a determination series, the 807 Dosing Unit «5 mL Standard or sample » is automatically prepared with rinsing water placed in position 28.

5.6 Leveler determination

5.6.1 Manual operation



- 807 Dosing Unit «50 mL VMS 1» has to be prepared with VMS 1.
- 807 Dosing Unit «2 mL Brightener» has to be prepared with brightener concentrate.
- 807 Dosing Unit «2 mL Suppressor» has to be prepared with suppressor concentrate.

- Leveler concentrate and plating bath samples are placed in positions 1 to 56 of the rack using the 50 mL sample vials (6.2747.010). It is not necessary to measure the exact sample volume, as this will automatically be done using the 807 Dosing Unit «5 mL Standard or sample».
- A 50 mL vial (6.2747.010) with deionized water for rinsing of the 807 Dosing Unit «5 mL Standard or sample» is placed in position 28 on the sample rack.

5.6.2 Workplace



- In the «Run» window on the tab «Determination series» create a sample table:

	Method	ID1	ID2	ID3	Sample type	Sample position	Sample amount	Sa...
1	MVA-24 – Leveler (CVS, RC) - with di...	Leveler Standard	Calibration Leveler	2	Standard	15	1.0	mL
2	MVA-24 – Leveler (CVS, RC) - with di...	Check Standard	Leveler determination	2	Sample	16	5	mL
3	MVA-24 – Leveler (CVS, RC) - with di...	Sample	Leveler determination		Sample	17	5	mL
4	MVA-24 – Leveler (CVS, RC) - with di...	Sample	Leveler determination		Sample	18	5	mL
5	MVA-24 – Leveler (CVS, RC) - with di...	Sample	Leveler determination		Sample	19	5	mL

Figure 21. Example sample table for leveler calibration and determination with solutions positioned as shown in **Figure 17**

- To run a calibration with a standard solution, select the sample type **STANDARD**. For a determination, the sample type **SAMPLE** has to be selected.
- The sample amount for sample type **STANDARD** has to be entered for technical reasons but has no effect on the calibration. The addition volume for the standard is defined in the method command **ADD STD – Add STANDARD RC**.
- The volume entered for «Sample amount» in case of the sample type **SAMPLE** will automatically be added when the addition of sample is due in the determination.
- Enter the number of «Prep cycles» for the 807 Dosing Unit «5 mL Standard or sample» if they should differ from 1 (ID3 in **Figure 21**). If no value is entered, the 807 Dosing Unit will be prepared once. See chapter 5.1 for recommendations regarding number of preparation cycles.
- The rinsing of 807 Dosing Unit «5 mL Standard or sample» with water at the end of the sample series does not need to be defined in the sample table. It is pre-programmed in the **SERIES END** track of the method.

5.6.3 Course of events

The execution calibration and determination by response curve technique is controlled by the 884 Professional VA and viva.

1. The measuring vessel is emptied using the 843 Pump Station.
2. 807 Dosing Unit «5 mL Standard or sample» is automatically prepared with leveler concentrate or sample from the vial on the rack of the sample changer. The preparation is repeated as many times as specified for «Prep cycles» (ID3 in **Figure 21**). In the example above, the standard solution for the calibration and the first sample after the calibration would be prepared twice, whereas the other samples would only be prepared once.
3. The measuring vessel is emptied and rinsed using the 843 Pump Station.
4. The electrolyte solution is automatically prepared by adding VMS 1 from the 807 Dosing Unit «50 mL VMS 1», suppressor concentrate from «2 mL Suppressor», and brightener concentrate from «2 mL Brightener».
5. After determination of the electrolyte value, either leveler standard or plating bath sample are added.
 - a. In the case of calibration, the volume of leveler standard defined in the command **ADD STD ADD STANDARD RC** in the method is added via port 1 of 807 Dosing Unit «5 mL Standard or sample».
 - b. In the case of sample determination, the volume of plating bath sample, as specified under sample amount, is added via port 3 of the 807 Dosing Unit «5 mL Standard or sample».
 - I. In the method «with dilution», the sample is added on top of the electrolyte solution.
 - II. In the method «no dilution», the measuring vessel is emptied before the sample is dosed.
6. Suppressor concentrate from 807 Dosing Unit «2 mL Suppressor» and brightener concentrate from 807 Dosing Unit «2 mL Brightener» are added together with the sample.
 - a. In the method «with dilution», the volumes for suppressor and brightener concentrate differ from the volumes used for the electrolyte solution.
 - b. In the method «no dilution», the volumes for suppressor and brightener concentrate are similar to the volumes used for the electrolyte solution.
 - c. In the case of calibration, no additional suppressor or brightener is added.
7. The software calculates the regression data for the calibration or the concentration of leveler in the plating bath sample.

8. At the end of each determination, the measuring vessel is automatically emptied and rinsed using the 843 Pump Station.

The next sample starts again from step 1.

- At the end of a determination series, the 807 Dosing Unit «5 mL Standard or sample» is automatically prepared with rinsing water placed in position 28.

6 Multiple determinations from one vial – modifications

If multiple additives (like suppressor, brightener, and leveler) should be determined in the same sample, the sample can be taken from the same vial on the rack without any intermediate preparation of 807 Dosing Unit «5 mL Standard or sample». It is not necessary to use separate sample positions for each additive.

	Method	ID1	ID2	ID3	Sample type	Sample position	Sample amount	Sa...
1	MVA-24 – Suppressor (CVS, DT)	Suppressor Sta...	Calibration Suppressor	2	Standard	1		
2	MVA-24 – Leveler (CVS, RC) - with dil...	Leveler Standard	Calibration Leveler	2	Standard	2	1.0	mL
3	MVA-24 – Suppressor (CVS, DT)	Check Standard	Suppressor determination	2	Sample	3		
4	MVA-24 – Brightener (CVS, MLAT)	Check Standard	Brightener determination		Sample	3	10	mL
5	MVA-24 – Leveler (CVS, RC) - with dil...	Check Standard	Leveler determination		Sample	3	5	mL
6	MVA-24 – Suppressor (CVS, DT)	Sample	Suppressor determination		Sample	4		
7	MVA-24 – Brightener (CVS, MLAT)	Sample	Brightener determination		Sample	4	10	mL
8	MVA-24 – Leveler (CVS, RC) - with dil...	Sample	Leveler determination		Sample	4	5	mL
9	MVA-24 – Suppressor (CVS, DT)	Sample	Suppressor determination		Sample	5		
10	MVA-24 – Brightener (CVS, MLAT)	Sample	Brightener determination		Sample	5	10	mL
11	MVA-24 – Leveler (CVS, RC) - with dil...	Sample	Leveler determination		Sample	5	5	mL
▶ *								

Figure 22. Example for a sample table with suppressor, brightener, and leveler determination from the same vial.

Prerequisites for this functionality:

- Determinations which should run from the same vial must be placed in consecutive order in the sample table (see **Figure 22**).
- Determinations which should run from the same vial must have the same sample position (see **Figure 22**).
- At the end of each determination, the current sample position must be assigned to a «Common Variable» and overwritten.
- At the beginning of each determination, the software must check whether the sample differs from the previous one. This is done by comparing the sample position with the previous sample position noted as the «Common Variable».

To implement the last two requirements, a few modifications in the configuration and the used methods are necessary.

6.1 Configuration



Create a new «Common Variable» with the name «Rack position».

How to:

If the «Common Variable» subwindow is not displayed in the «Configuration», then go to the menu bar **VIEW ► QUICK ACCESS TO CONFIGURATION SUBWINDOWS ► COMMON VARIABLES**.

Create a new variable with **EDIT ► NEW...**

Name	Rack position
Type	Number
Value	(blank)
Unit	(blank)

6.2 Method

The following changes have to be implemented in all methods that need the possibility to run separate determinations from the same vial.



6.2.1 Method run

The command **CALL – PREP SAMPLE OR STANDARD** should only be carried out under the condition that the position of the current sample differs from the position of the previous sample.

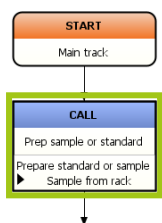



Figure 23. Method snippet: call for the preparation of the 807 Dosing Unit «5 mL Standard or sample» in the main track.

How to:

- Open the properties of the command.

- In the call table of the window «CALL – Prep sample or standard», select the line «Prepare standard or sample – Sample from rack» and open the properties.
- In the window «Call – Prepare standard or sample», activate the check box for «Condition».
- Use the formular editor  to define the condition (see **Figure 24**):

'SD.Sample position' <> 'CV.Rack position'

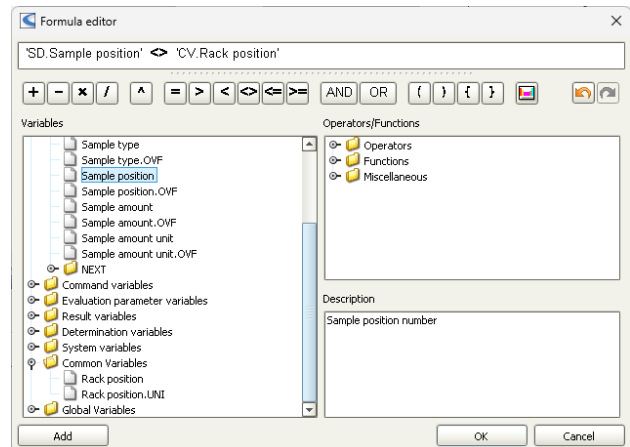

Figure 24. Formula editor to define the conditions under which the preparation of 807 Dosing Unit «5 mL Standard or sample» should be carried out.

6.2.2 Evaluation – Results

To make the position of the current sample available for the next determination, the value has to be written into the «Common Variable» defined in 6.1.

How to:

- On the tab «User-defined results», create a new result:

Result type	Single result
Result name	Rack position
Formula*	'SD.Sample position'
Unit	(blank)
Decimal places	0
Assignment	none

* Use the formula editor  to enter the formula.

- On the tab «Assignment of variables», assign the new «User-defined result» to the «Common Variable». Click on  to select the common or result variable.

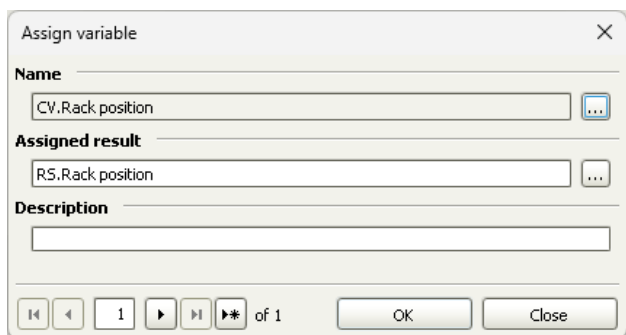

Figure 25. Window in which the result variable is assigned to the common variable.

7 Comments

7.1 Storing 807 Dosing Units

When an 807 Dosing Unit is not used for a longer period of time (during the night, over the weekend), it should be rinsed with deionized water. For storage, the 807 Dosing Unit should not be emptied. Instead, it is kept with the dosing cylinder filled with deionized water.

When highly concentrated solutions, such as VMS, additive concentrates, or plating bath samples, are left in the 807 Dosing Unit, crystals or elemental copper can form. This can damage the 807 Dosing Unit in various ways. Deposits between the valve and distributor disk can cause them to stick together or cause leakages. Crystals in the dosing cylinder can compromise the seal between the dosing piston and the glass cylinder. Crystals in capillary tubing can cause blockages, which can ultimately damage the 800 Dosino if the overpressure causes solution to leak into the electronics.

Please also refer to the 807 Dosing Unit manual for recommendations regarding maintenance and greasing of 807 Dosing Units.

7.2 Storing electrodes

When the electrodes are not used (during the night, over the weekend), they should be thoroughly rinsed with deionized water.

Working and auxiliary electrode can either be stored in deionized water or dry.

The reference electrode should be stored separately in a storage vessel (e.g., 6.2008.040). The vessel can either be filled with KCl solution ($c(\text{KCl}) = 3 \text{ mol/L}$) or KNO_3 solution ($c(\text{KNO}_3) = 1 \text{ mol/L}$), in case KNO_3 is used as bridge

electrolyte. Filling the storage vessel to the maximum level prevents the reference electrode from running dry.

7.3 Waste and rinsing container

Care must be taken to ensure that the containers for waste and rinsing are not closed completely. Keep at least one opening unsealed for pressure balancing. Overpressure would lead to a malfunction of the pumps.

7.4 894 Professional CVS

Instead of the 884 Professional VA, the 894 Professional CVS (2.894.1210) can also be used in this setup, as well as the two instrument versions with three 800 Dosinos (2.884.1310, 2.894.1310).

7.5 More 807 Dosing Units

If more than the five 807 Dosing Units described in chapter 2 should be used, please refer to AB-401 for recommendations regarding electrical and tubing connections.

7.6 Measuring vessel

With the electrode equipment for CVS (e.g., 6.5339.010) two different measuring vessels with different capacities are supplied (see **Table 3**). The minimum volume is given by the fact that all three electrodes must be immersed into solution. The limit for the maximum volume results from the distance between the solution level and the bottom of the measuring head insert, which should be at least 1 cm. The measuring vessel must be selected according to the volumes used in the applications. To fit into the limits of the measuring vessel, volumes in the application can also be adapted.

Table 3. Capacities of measuring vessels.

Measuring vessel	Min. volume	Max. volume
6.1415.210	10 mL	70 mL
6.1415.250	30 mL	150 mL

7.7 Example methods

The methods provided with this Application Bulletin are compatible with **viva** 3.0.