

## Application Bulletin 418/3 e

# Use of the Polytron PT 1300 D (Metrohm version)

### Industry sector

Chemical; pharmaceuticals; food & beverage; fertilizers & explosives; personal care & cosmetics

### Keywords

Titration; Karl Fischer titration; volumetric; automation; MATi 11; water content; homogenization; Polytron; sample preparation; 815 Robotic Soliprep; S01; S010; S04; S040; S07; S070; S11; S110; S111; S112; S12; S120; S121; S123

### Summary

This Application Bulletin provides information on the use of the Kinematica Polytron PT 1300 D homogenizer (Polytron).

### Instruments and accessories

The Polytron consists of a control and a drive unit. A quick coupling system allows the changing of the dispersing aggregates (discussed later in this document) without further tools.

Three different versions of the Polytron exist. Version 1 (Figures 1 and 2) and version 2 (Figures 3 and 4) are almost identical. The two control units only differ in the connector for the drive and the RS-232 connector.

The drives are not compatible with the control unit of a different version, even if the connector is the same (e.g., drive of version 3 cannot be used in combination with a control unit version 2).



Figure 1: Polytron version 1 – front view control unit.



Figure 2: Polytron version 1 – rear view control unit.



Figure 3: Polytron version 2 – front view control unit.



Figure 4: Polytron version 2 – rear view control unit.



Figure 5: Polytron version 3, control unit (left) and drive (right).



Figure 6: Polytron version 3 – rear view control unit.

### Aggregates

The aggregates are used to homogenize samples and to stir the mixture during the titration. Depending on the type of sample to be homogenized (see Table 1), one of the aggregates shown in Figure 7 can be chosen.



Figure 7: Aggregate 6.9012.000 (left) and aggregate 6.9012.010 with protruding knives (right).

Table 1: Recommended aggregate depending on sample type.

Aggregate	Samples
6.9012.000	<ul style="list-style-type: none"> <li>Viscous samples</li> <li>Samples smaller than the diameter of the aggregate</li> <li>Powders and salts that are difficult to dissolve</li> </ul>
6.9012.010	<ul style="list-style-type: none"> <li>Solid samples</li> <li>Samples larger than the diameter of the aggregate</li> </ul>

**Cable connections for RS232-control**

Table 2: Accessories needed to connect the Polytron.

	900 TC/Ti-Touch	tiamo™/OMNIS
Version 1	6.2148.050	6.2134.040
	6.2134.040	6.2148.050
Version 2	6.2148.050	6.2134.110
	6.2134.110	6.2148.050
Version 3	6.2148.050	6.2134.110
	6.2134.110	6.2148.050

**Configuration**

**900 Touch Control and Ti-Touch**

To connect a Polytron to a 900 Touch Control or a Ti-Touch instrument, open the System settings and then the Device manager (Figure 8). There, a new USB/RS-232 adapter is created. Highlight the USB/RS-232 adapter and press Edit (Figure 9). A new window opens and shows the settings of two COM-ports (Figure 10). Highlight COM1 and press Edit again, then enter the following settings: 2400 / 8 / none / 1 / none (Figure 11).

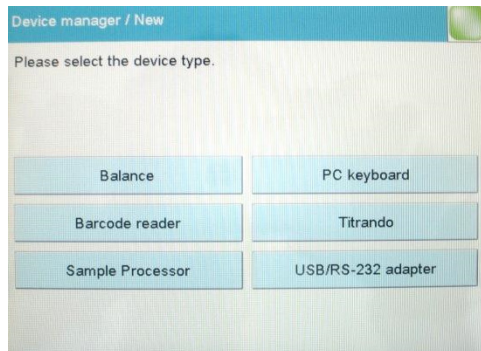

Figure 8: Device manager – create new device.

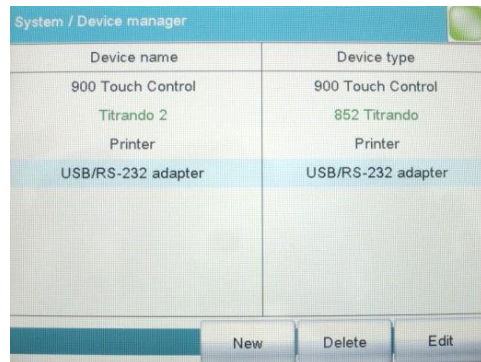

Figure 9: Device manager – overview devices.

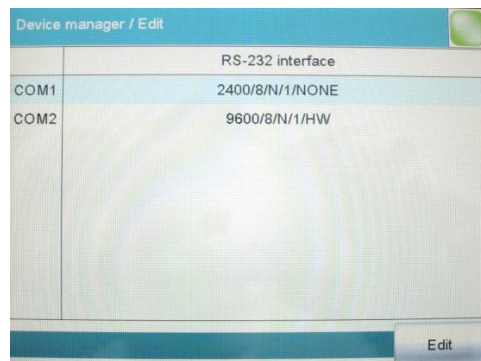

Figure 10: Device manager – COM-ports.

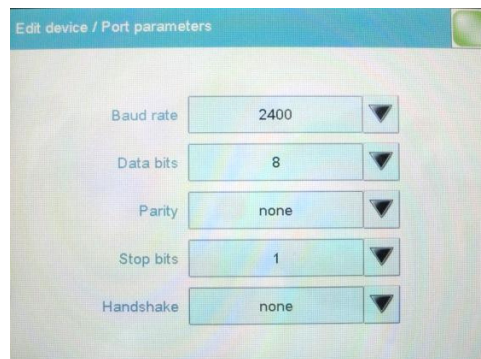

Figure 11: Settings for COM-port 1.

### tiamo™ and OMNIS

If the 6.2148.050 converter is used to connect the Polytron to a **tiamo™** or OMNIS system, please make sure the driver of the converter is installed before the software is started. Depending on the connection to the PC, the COM-port can change and does not necessarily need to be COM1 or COM8 as shown in Figures 12 and 13.

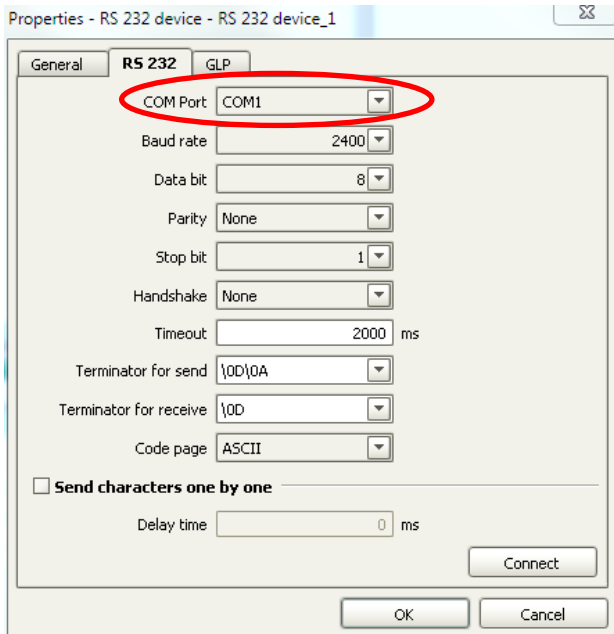

Figure 12: Configuration of the Polytron in **tiamo™**.

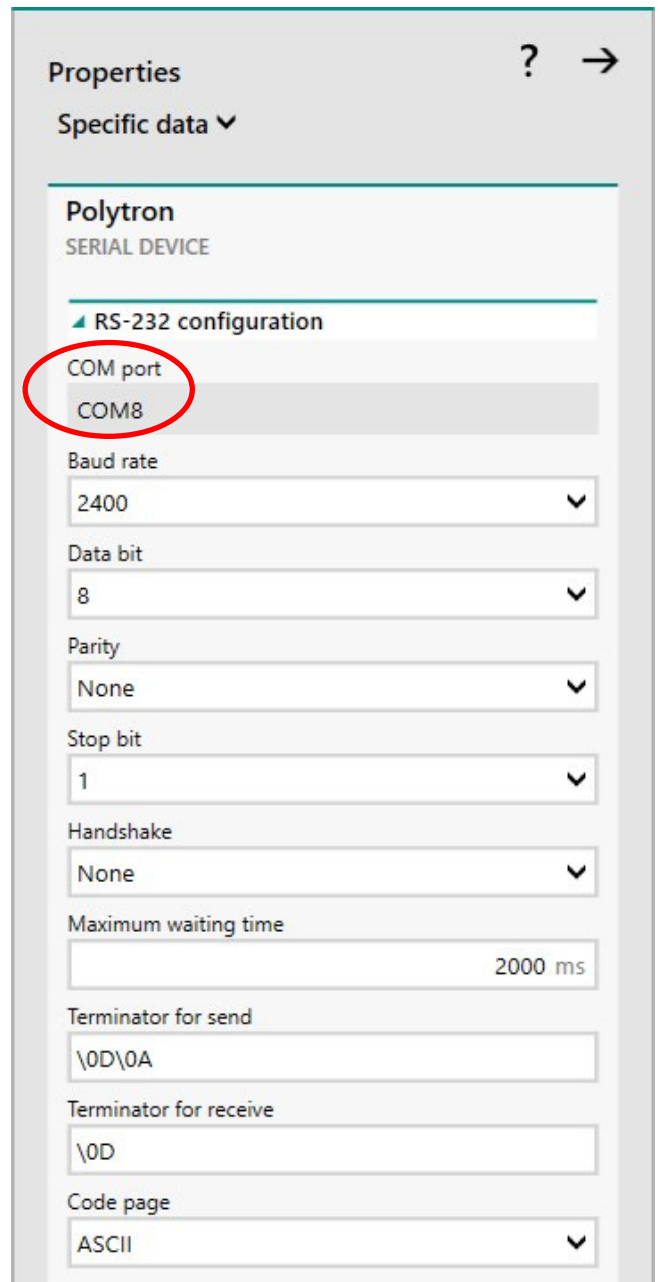

Figure 13: Configuration of the Polytron in OMNIS.

### Control

The Polytron is controlled via Control RS commands with a 900 Touch Control/Ti-Touch, with Transfer commands in the **tiamo™** software (Figure 14) or with Write commands in the OMNIS software (Figure 15).

To switch the Polytron on or off and to set a speed in **tiamo™** use a Transfer command, choose "Write" as Action and as Command the three-digit code (Table 3 or Table 4) which corresponds to the required result.

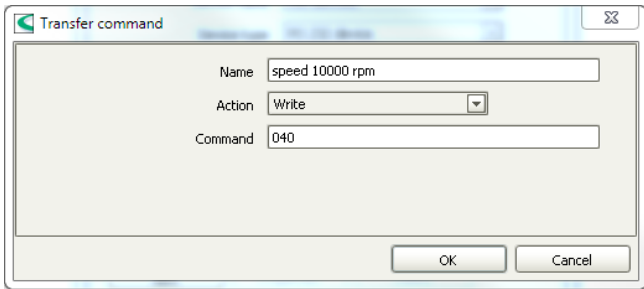

Figure 14: Transfer command in *tiamo*™ to control the Polytron.

In OMNIS, add a WRITE command and enter the required three-digit code (Table 3 or Table 4) in the character string field (Figure 15).

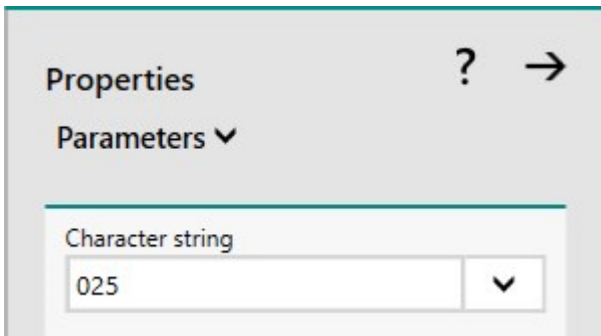

Figure 15: Properties of the Write command in OMNIS.

The following two tables show the three-digit codes available for Polytron versions 1, 2, and 3.

Table 3: Three-digit codes to control Polytron versions 1 and 2.

Result	Code
Switch on	254
Switch off	253
Speed of Polytron	252* (answers: 0–250 → speed 5,000-30,000 rpm; 251 → speed > 30,000 rpm; 255 → speed < 5,000 rpm)
7,000 rpm	000
7,100	001
7,200	002
7,300	003
7,400	004
7,500	005
10,000	030
15,000	080
20,000	130
25,000	180

Table 4: Three-digit codes to control Polytron version 3.

Result	Code
Switch on	254
Switch off	253
Speed of Polytron	252* (answers: 0-140 → speed 2,000–30,000 rpm; 141 → speed < 2,000 rpm; 142 → speed > 30,000 rpm)
2,000 rpm	000
2,200	001
2,400	002
2,600	003
2,800	004
3,000	005
5,000	015
10,000	040
15,000	065
20,000	090
25,000	115
30,000	140
Status of Polytron	143* (answers: 150 → OFF; 151 → ON; 152 → Overload; 153 → Over temperature)
Speed attained	144* (answers: 170 → NO; 171 → YES)

The codes marked with \* can be used with the *tiamo*™ and OMNIS software only (see next chapter: additional commands).

#### Additional commands (*tiamo*™ and OMNIS only)

##### *tiamo*™

If the current speed or the status of the Polytron must be read, then a Method variable to store the value is needed. A Method variable can be defined in the START command of the Main track of a *tiamo*™ method. Open the properties of the START command and choose Method variables (Figure 16).

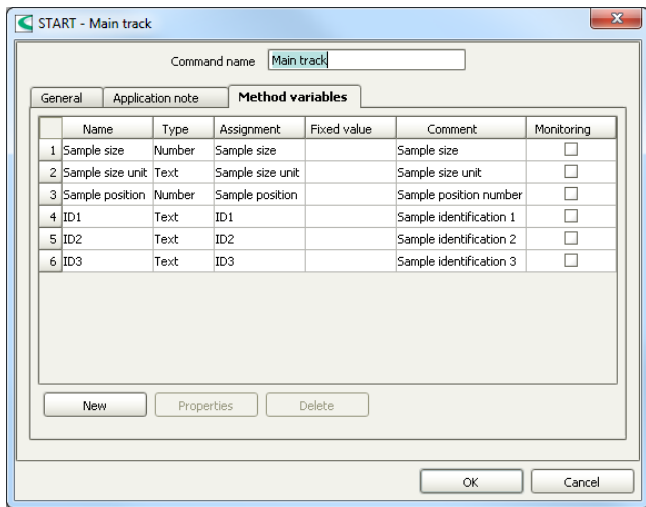

Figure 16: Properties of a START command in the Main track of a **tiamo™** method.

Enter a Name and define the type of the new Method variable as "Text". Deactivate the assignment to an ID and activate Fixed value instead. Do not enter a value in this field. Confirm the settings by pressing the OK button (Figure 17).

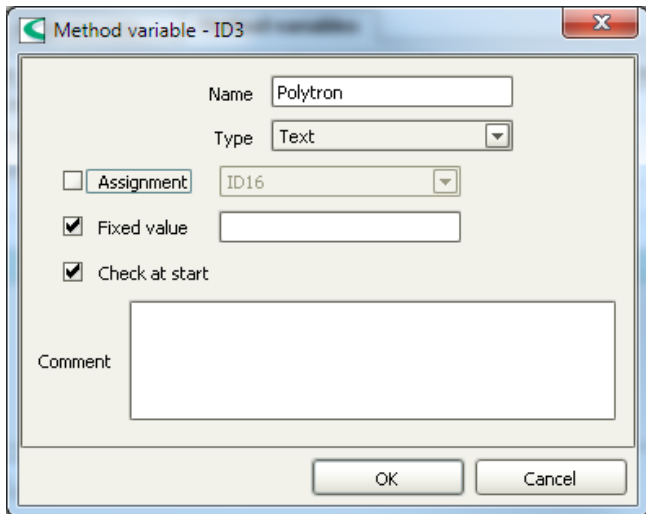

Figure 17: Method variable to store data from a Polytron.

To read the status or the current speed of the Polytron, a Transfer command (Figure 18) is used. Choose "Read" as the choice for Action and enter the corresponding three-digit code (Table 3 or Table 4) as Command. Additionally, you define the new Method variable as Variable.

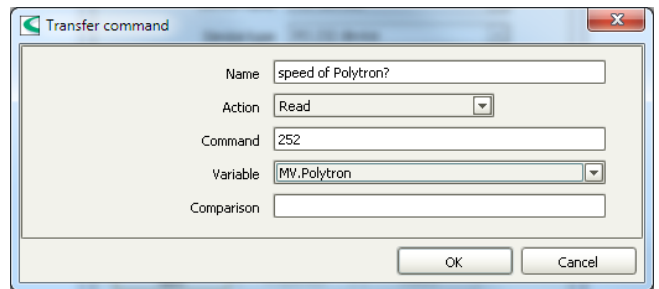

Figure 18: Transfer command to read data from a Polytron.

### OMNIS

To read the current speed or the status of a Polytron in OMNIS, proceed as follows. Create an OP with a subsample variable as shown in Figure 19.

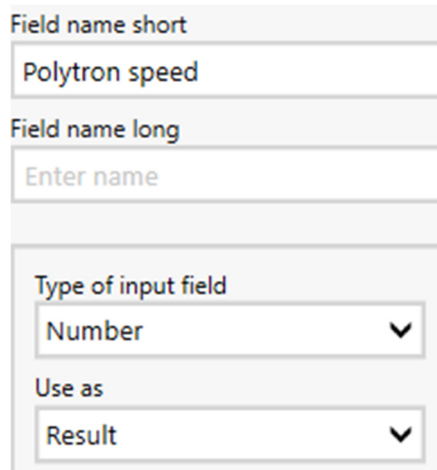

Figure 19: Subsample variable in OMNIS to save the current speed of the Polytron.

To read the current speed in a method using the Polytron, you need to add a READ command (Figure 20) to the method.



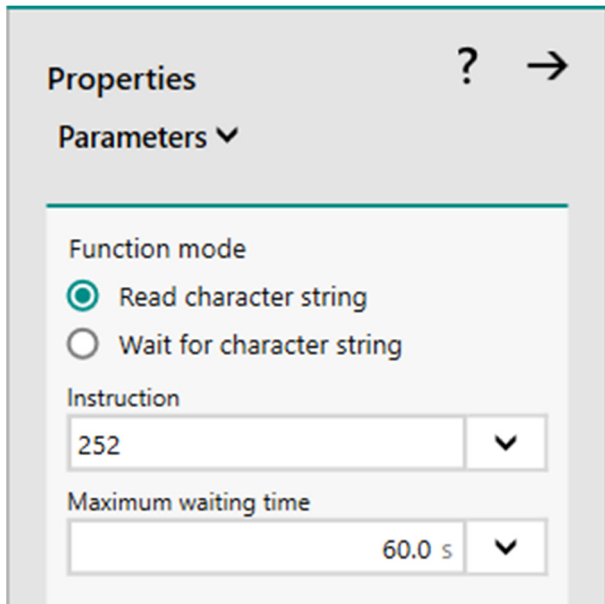

Figure 20: Properties of the READ command.

The three-digit code of 252 will result in an answer from the Polytron. The answer is another three-digit code that stands for the current speed of the Polytron (see Table 4).

Additionally, a CALC command is required to calculate the speed from the three-digit code answer and to save it as a result in the defined subsample variable (Figure 21).

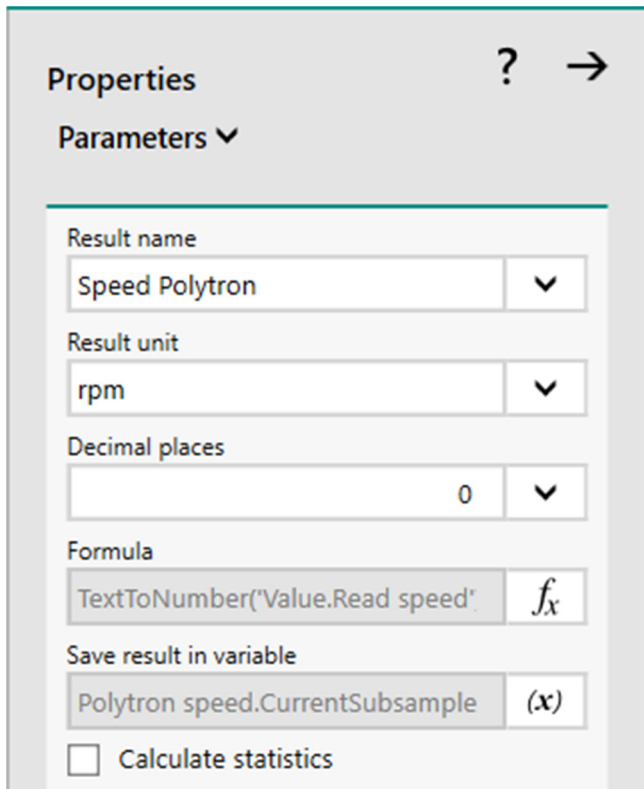

Figure 21: Properties of the CALC command.

Enter the following formula:

`TextToNumber('Value.Read speed')*200+2000`

Make sure you use the value of the READ command in the calculation.

The speed of the Polytron will then be shown as result in the OMNIS sample list.

### Watchdog timer

With firmware version C05, the Polytron version 3 offers a watchdog timer for the interface (RS232). The firmware version is indicated on the drive unit after switching the device on. The watchdog timer is inactive by default and needs to be activated. Use the following three-digit codes in Table 5 to activate and deactivate the watchdog timer or to ask the status of the settings:

Table 5: Three-digit codes to control the watchdog timer.

Code	Result
145	Activates the watchdog timer for the interface. If there is no command received within 30 s, the Polytron stops. It can be reactivated via the interface, but the watchdog timer will remain activated.
146	Deactivates the watchdog timer for the interface. There is no time surveillance of the interface. This corresponds to the status after switching the device off and on again.
147	With this code, the status of the watchdog timer can be polled. The following answers are possible: 180 → The watchdog timer is deactivated 181 → The watchdog timer is activated

**Please note:** Switching the device off and on again deactivates the watchdog timer.

### Polytron in Karl Fischer Titration (volumetric) stand alone

The Polytron can be used to homogenize samples directly in the titration vessel, which avoids loss or absorption of water by the sample.

#### *Titrande and Ti-Touch*

To use the Polytron in KF titration, the KF titration vessel lid (6.1414.030) is replaced by the Micro titration vessel lid ECO (6.1414.060). Additionally, the parts shown in Figure 22 and Table 6 are necessary and need to be ordered separately.

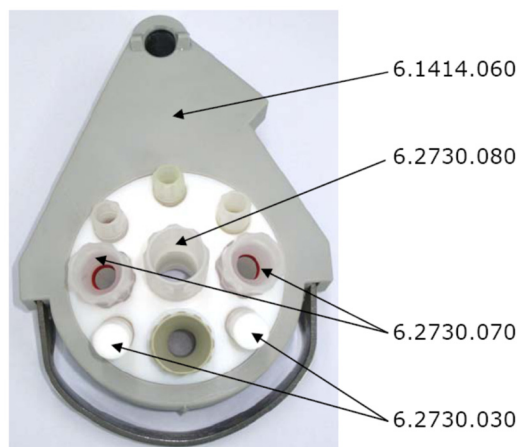

Figure 22: 6.1414.060 for the use with Polytron.

Table 6: Additional accessories.

Number of items	Ordering number
2	6.2730.030
2	6.2730.070
1	6.2730.080

The Polytron holder 6.2047.110 (Figure 23) is available to fasten the Polytron to the support rod of the titration system. It includes two spacers which allow the use of both aggregates (Figure 7).



Figure 23: 6.2047.110 holder for Polytron with spacers.

### Eco Titrator

For the use of a Polytron with an Eco Titrator, the 6.01405.060 Eco titration vessel lid for Polytron is used. To attach the Polytron to the support rod of the Eco Titrator, the 6.02008.030 holder is required. The 6.05610.060 set contains all necessary accessories to use the Polytron with an Eco Titrator (including the titration vessel lid, the holder for the Polytron, etc.).



Figure 24: 6.01405.060 Eco titration vessel lid for Polytron.



Figure 25: 6.02008.030 Holder for homogenizer for Eco Titrators.

### OMNIS

To use a Polytron with an OMNIS Titrator, the 6.01405.040 OMNIS titration vessel lid for Polytron is needed. To secure the Polytron to the support rod of the OMNIS Titrator, the 6.02008.010 holder is required. The 6.05609.010 set contains all necessary accessories to use the Polytron with an OMNIS Titrator (including the titration vessel lid, the holder for the Polytron, etc.).



Figure 26: 6.01405.040 OMNIS titration vessel lid for Polytron.



Figure 27: 6.02008.010 Holder for homogenizer for OMNIS.

### Polytron in automation

The homogenization with a Polytron can be automated. Figures 19–25 show the available Robotic arms and the Titration heads which can be used in combination with a Polytron. Not all Robotic arms are compatible with all Titration heads. The compatibility can be checked in Table 7.

#### Robotic arms



Figure 28: 6.1462.250 Robotic titration arm with Polytron holder, left swinging (used in combination with 786 Swing Head) and equipped with one buret tip for solvent addition and three spray nozzles for cleaning.



Figure 29: 6.9914.140 Robotic arm with holder for titration head and Polytron, right swinging. Aggregate in the center of the titration beaker (used in combination with a 786 Swing head).



Figure 30: 6.9914.156 Robotic arm with holder for titration head and Polytron, right swinging, aggregate off-centered (used in combination with a 786 Swing head).

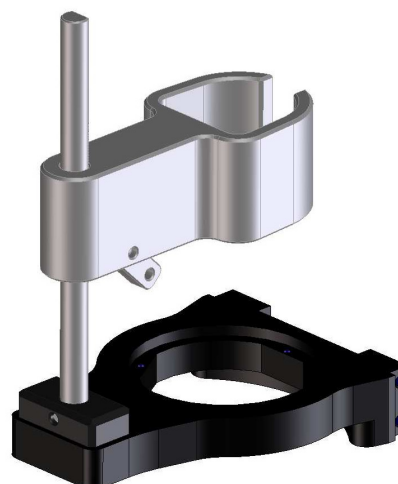

Figure 31: 6.9914.164 Titration head and Polytron holder (used in combination with a 814 USB Sample Processor).



**Titration heads**

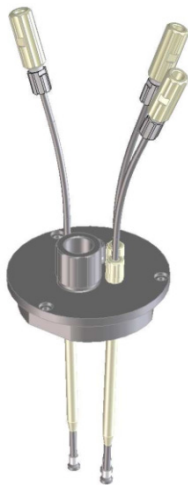

Figure 32: 6.9914.139 (with three reinforced buret tips).



Figure 33: 6.9914.141 (with three buret tips and three spray nozzles for cleaning).



Figure 34: 6.9914.157 (with three buret tips, three spray nozzles, aspiration tip and 1 x NS14).

Table 7: Possible combinations of special robotic arms with titration heads.

Titration heads	Robotic arms		
	6.9914.139	6.9914.141	6.9914.157
6.1462.250	no	no	no
6.9914.140	yes	yes	no
6.9914.156	no	no	yes
6.9914.164	yes	yes	no

**Titration heads for OMNIS**



Figure 35: 6.01403.050 (with two reinforced buret tips).

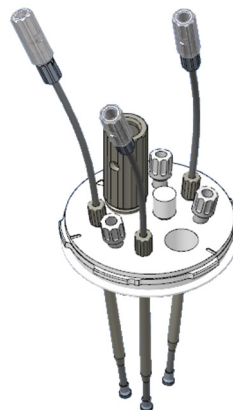

Figure 36: 6.09914.004 (with three reinforced buret tips).

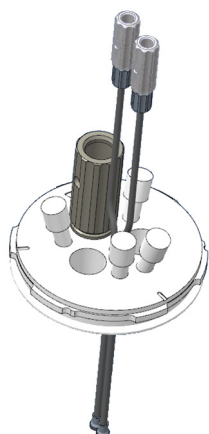

Figure 37: 6.09914.005 (with two reinforced buret tips).

Table 8: Possible combinations of special robotic arms with titration heads.

Sample beaker	Titration head		
	6.01403.050	6.09914.004	6.09914.005
6.01402.000	yes	no	no
6.01402.003			
6.01400.200	yes	no	yes
6.01400.300	yes	no	yes
6.01400.303			
6.01400.100	no	yes	no
6.01400.000	no	yes	no
6.01400.003			

### Comments

- Only run the Polytron with the connected aggregate immersed in a liquid (see Figure 38). Otherwise, the Polytron can be damaged. Running the drive without a connected aggregate is possible. Never put your finger into the drive when it is running!

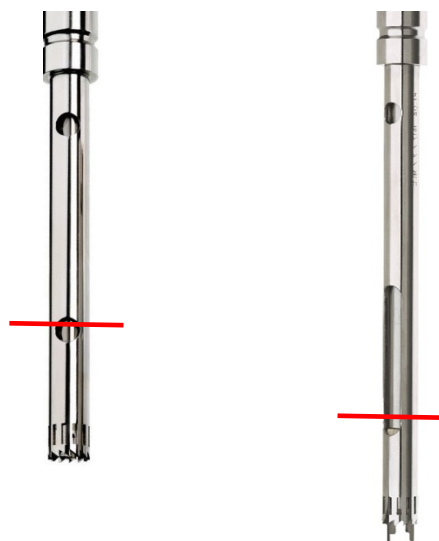

Figure 38: Minimum liquid level (red line) for aggregate 6.9012.000 (left) and 6.9012.010 (right).

- For optimal homogenization it is recommended to vary the speed of the Polytron during the homogenization.
- Depending on the setup the Polytron can automatically be swung between center and wall of the beaker to get a better homogenization.
- Once the Polytron is connected to the **tiamo**<sup>™</sup> or the OMNIS software, manual control is no longer possible. It is blocked until the Polytron is disconnected in the Configuration window of the **tiamo**<sup>™</sup> or OMNIS software.
- It is recommended to clean the aggregate on a regular basis. The tool to disconnect rotor and stator from each other comes with the aggregate.
- Metrohm offers two different aggregate types for the most common applications. Sometimes the samples require the usage of a different aggregate. More information on other aggregate types that can be connected to the Polytron can be found on [www.kinematica.ch](http://www.kinematica.ch).
- Never close all holes of the aggregate while it is running as it can lead to sample solution being aspirated into the drive unit. Do not place the drive unit lower than the connected wet aggregate for the same reason.

### Author

Competence Center Titration

Metrohm International Headquarters